



N° d'ordre:

UNIVERSITE PARIS-SUD  
FACULTE DES SCIENCES D'ORSAY

## THÈSE

Présentée pour obtenir

LE GRADE DE DOCTEUR EN SCIENCES  
DE L'UNIVERSITE PARIS XI

Spécialité : Mathématiques  
par  
Nicolas CURIEN

Cartes Planaires Aléatoires et  $\frac{\sqrt{17} - 3}{2}$ .

Soutenue le X/VI/MMXI devant la commission d'examen :

M. Jean BERTOIN	(Examineur)
M. Philippe CHASSAING	(Rapporteur)
M. Emmanuel GUITTER	(Examineur)
M. Jean-François LE GALL	(Directeur de thèse)
M. Gilles SCHAEFFER	(Examineur)
M. Wendelin WERNER	(Examineur)
M. Thomas DUQUESNE	(Membre Invité)
M. Grégory MIERMONT	(Membre Invité)

et s'appuyant sur le rapport de M. Omer ANGEL (Rapporteur)





## Remerciements (avec index bien sûr!) \_\_\_\_\_

Avertissement au lecteur : Sans avilir les mots, il se peut que quelques contrepèteries aient échappées à la vigilance de l’auteur. Si vous aimez fouiller dans les coins, à vous de les retrouver !

**E**nfin quitte au but après trois belles années de thèse ! Ces quelques lignes seront, j’en suis sûr, les plus lues de ce manuscrit. Non pas qu’elles soient plus compréhensibles que le reste (quoique), mais car le sujet traité intéresse beaucoup plus de gens.

Évidemment, les plus profonds remerciements vont à [20]. Véritable architecte de mon parcours mathématique depuis la première année de l’école où la rigueur et la limpidité de ses cours m’ont (comme beaucoup) poussé vers les probabilités. Extrêmement généreux sur les idées, le temps, et les voyages (pardon, les conférences), il m’a donné les meilleures conditions imaginables pour la réalisation d’une thèse. J’espère encore beaucoup apprendre auprès de lui.

Merci également à mon confrère taste-andouille [3]. Il m’a initié aux mathématiques israéliennes décontractées, au questionnement hyperbolique et aux délices culinaires libanais (surtout [3, Épouse]). Ses conjectures aiguisées basées sur une intuition géométrique profonde mettront encore beaucoup de probabilistes à l’épreuve. **תודה רבה**

C’est un grand honneur pour moi d’avoir [1] et [8] comme rapporteurs. Le premier m’a fait découvrir que le groupe symétrique a des applications inattendues dans l’art du carillonnement tandis que [8] a été le directeur de mon premier stage de recherche en 2006 (et oui déjà !). Un grand merci à [5, 8, 12, 18, 20, 23, 28, 35] d’avoir accepté de faire partie de mon jury matheux.

Bien entendu ce manuscrit doit beaucoup à mes coauteurs (ou futurs coauteurs) [3, 19, 20, 22, 23, 24] qui m’ont aidé à faire des papiers bien condensés. Grâce à eux, j’ai été bonifié par cette thèse. Je tiens à remercier profondément [23] pour les nombreuses heures consacrées durant l’année 2008-2009 (souvent pour répondre à diverses questions idiotes). Merci aussi à [24] qui m’a appris ô combien la technique du second moment est efficace et à [19] avec qui j’ai expérimenté la recherche entre amis.

Dès 2008 j’ai été accueilli dans ce nid douillet qu’est le DMA. Je me souviens encore quand [13] (que j’avais alors prise pour [2]) m’a tout de suite repéré au pied de l’escalier et m’a amené à mon premier bureau rempli de parfum féminin, merci [25] ! Je fus alors l’un des espions [15, 16, 27, 35] de l’équipe proba incrusté dans le couloir des algébristes. La survie fut facile et les autochtones très accueillants, mais je fus rapatrié au bout d’un an dans le sacro-saint passage vert pour partager le bureau V2 avec [30] dont l’organisation n’a d’équivalent que la perfection de ses documents  $\text{\TeX}$ . À cette

époque, le V6 [6, 26, 32, 33], porte entre-ouverte par une basketette<sup>1</sup>, régnait en despote éclairé sur le passage et ses affluents : le V7 [10, 21], le V8 [34], la salle Verdier et bien sûr la machine à café. Les habitants ont changé [4, 7, 11, 17, 29, 31] mais pas l’ambiance ! Merci aussi aux trois fées [2, 13, 34] dont la bonne humeur emplit les locaux et à qui les mathématiques françaises doivent beaucoup ;)

Enfin, pêle-mêle et avec possible répétition, un immense merci aux amis d’enfance, de promo, de travail, de passage, de musique, aux collègues, à mes profs et ancien profs, aux élèves sur qui j’aiguise ma pédagogie, à toutes ces bouilles incroyables qui me font sourire avec une dédicace spéciale à

⏟  
mets ton nom ici

Merci enfin à toute ma famille [9] et à [14], soutien inconditionnel et source de bonheur sans fin (ni cesse) !

---

1. pour ne pas abolir les mythes, je ne révélerai pas pas le nom de son propriétaire



## Résumé

## Abstract

**D**ans ce travail, nous nous sommes intéressés à l'étude asymptotique d'objets combinatoires aléatoires. Deux thèmes ont particulièrement retenu notre attention : les cartes planaires aléatoires et les modèles combinatoires liés à la théorie des fragmentations.

La théorie mathématique des cartes planaires aléatoires est née à l'aube de notre millénaire avec les travaux pionniers de Benjamini & Schramm, Angel & Schramm et Chassaing & Schaeffer. Elle a ensuite beaucoup progressé, mais à l'heure où ces lignes sont écrites, de nombreux problèmes fondamentaux restent ouverts. Résumons en quelques mots clés nos principales contributions dans le domaine : l'introduction et l'étude du cactus brownien (avec J.F. Le Gall et G. Miermont), l'étude de la quadrangulation infinie uniforme vue de l'infini (avec L. Ménard et G. Miermont), ainsi que des travaux plus théoriques sur les graphes aléatoires stationnaires d'une part et les graphes empilables dans  $\mathbb{R}^d$  d'autre part (avec I. Benjamini).

La théorie des fragmentations est beaucoup plus ancienne et remonte à des travaux de Kolmogorov (1941) et de Filippov (1961). Elle est maintenant bien développée (voir par exemple l'excellent livre de J. Bertoin), et nous ne nous sommes pas focalisés sur cette théorie mais plutôt sur ses applications à des modèles combinatoires. Elle s'avère en effet très utile pour étudier différents modèles de triangulations récursives du disque (travail effectué avec J.F. Le Gall) et les recherches partielles dans les quadrees (travail effectué avec A. Joseph).

Bonne lecture !

**T**he subject of this thesis is the asymptotic study of large random combinatorial objects. This is obviously very broad, and we focused particularly on two themes : random planar maps and their limits, and combinatorial models that are in a way linked to fragmentation theory.

The mathematical theory of random planar maps is quite young and was triggered by works of Benjamini & Schramm, Angel & Schramm and Chassaing & Schaeffer. This fascinating field is still growing and fundamental problems remain unsolved. We present some new results in both the scaling limit and local limit theories by introducing and studying the Brownian Cactus (with J.F. Le Gall and G. Miermont), giving a new view point, a view from infinity, at the Uniform Infinite Planar Quadrangulation (UIPQ) and bringing more theoretical contributions on stationary random graphs and sphere packable graphs (with I. Benjamini).

Fragmentation theory is much older and can be tracked back to Kolmogorov and Filippov. Our goal was not to give a new abstract contribution to this well-developed theory (see the beautiful book of J. Bertoin) but rather to apply it to random combinatorial objects. Indeed, fragmentation theory turned out to be useful in the study of the so-called random recursive triangulations of the disk (joint work with J.F. Le Gall) and partial match queries in random quadrees (joint work with A. Joseph).

Enjoy !

# Table des matières

---

<b>I</b>	<b>Introduction</b>	<b>7</b>
<b>1</b>	<b>Cartes planaires aléatoires</b>	<b>9</b>
1.1	Cartes planaires . . . . .	9
1.1.1	Définition . . . . .	9
1.1.2	A Census of Censuses of planar maps . . . . .	11
1.1.3	Géométrie aléatoire . . . . .	13
1.1.4	Science Fiction . . . . .	14
1.2	Limite d'échelle . . . . .	14
1.2.1	Description de la bijection Cori-Vauquelin-Schaeffer . . . . .	14
1.2.2	Rayon et profil . . . . .	17
1.2.3	Gromov-Hausdorff . . . . .	19
1.2.4	Le cactus brownien (Chap. 3 ou [48]) . . . . .	20
1.3	Limite locale . . . . .	25
1.3.1	Convergence . . . . .	25
1.3.2	Petit Historique . . . . .	26
1.3.3	L'approche de Benjamini et Schramm . . . . .	27
1.3.4	Dimension supérieure (Chap. 4 ou [16]) . . . . .	29
1.3.5	Invariance de long de la marche aléatoire (Chap. 5 ou [17]) . . . . .	30
1.3.6	L'UIPQ vue de l'infini (Chap. 6 ou [49]) . . . . .	32
<b>2</b>	<b>Racine de 17 moins 3 sur 2.</b>	<b>36</b>
2.1	Théorie des fragmentations . . . . .	36
2.1.1	Présentation . . . . .	36
2.1.2	Martingale Malthusienne . . . . .	37
2.2	Triangulations récursives (Chap. 7 ou [47]) . . . . .	38
2.2.1	Processus de hauteur . . . . .	39
2.2.2	Triangulation . . . . .	40
2.3	Quadtrees (Chap. 9 ou [46]) . . . . .	42
<b>II</b>	<b>Cartes Planaires Aléatoires</b>	<b>45</b>
<b>3</b>	<b>The Brownian Cactus</b>	<b>47</b>
3.1	Introduction . . . . .	47

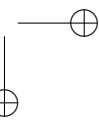
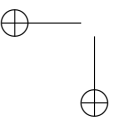
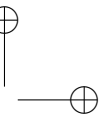
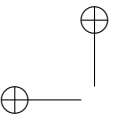

TABLE DES MATIÈRES

3.2	Discrete and continuous cactuses . . . . .	51
3.2.1	The discrete cactus . . . . .	51
3.2.2	The continuous cactus . . . . .	54
3.2.3	Continuity properties of the cactus . . . . .	55
3.2.4	Convergence of discrete cactuses . . . . .	57
3.2.5	Another approach to the continuous cactus . . . . .	58
3.3	The Brownian cactus . . . . .	61
3.4	Convergence of cactuses associated with random planar maps . . . . .	64
3.4.1	Planar maps and bijections with trees . . . . .	64
3.4.2	Random planar maps . . . . .	70
3.4.3	The shuffling operation . . . . .	72
3.4.4	Proof of Theorem 3.20 under Assumption (A1) . . . . .	75
3.4.5	The bipartite case . . . . .	79
3.5	The dimension of the Brownian cactus . . . . .	79
3.6	Separating cycles . . . . .	82
3.7	Appendix . . . . .	86
<b>4</b>	<b>On limits of Graphs Sphere Packed in Euclidean Space and Applications</b>	<b>91</b>
4.1	Introduction . . . . .	91
4.2	Notations and terminology . . . . .	92
4.2.1	Packings . . . . .	92
4.2.2	$d$ -parabolicity . . . . .	93
4.2.3	Limit of graphs . . . . .	94
4.3	Proof of Theorem 4.9 . . . . .	94
4.4	Geometric applications . . . . .	97
4.4.1	Isoperimetric inequalities and alternative . . . . .	97
4.4.2	Non existence of $M$ -uniform packing . . . . .	100
4.5	Open problems . . . . .	100
<b>5</b>	<b>Stationary Random Graphs</b>	<b>103</b>
5.1	Introduction . . . . .	103
5.1.1	Definitions . . . . .	105
5.2	Connections with other notions . . . . .	106
5.2.1	Ergodic theory . . . . .	107
5.2.2	Unimodular random graphs . . . . .	107
5.2.3	Measured equivalence relations . . . . .	108
5.3	The Liouville property . . . . .	109
5.4	The Radon-Nikodym Cocycle . . . . .	114
5.5	Applications . . . . .	117
5.5.1	The Uniform planar quadrangulation . . . . .	117
5.5.2	Long range percolation clusters . . . . .	118
5.5.3	Planarity . . . . .	119

<b>6</b>	<b>The UIPQ seen from <math>\infty</math></b>	<b>123</b>
6.1	Introduction . . . . .	123
6.2	Random trees and the UIPQ . . . . .	126
6.2.1	Spatial trees . . . . .	126
6.2.2	Finite and infinite quadrangulations . . . . .	127
6.2.3	The Schaeffer correspondence . . . . .	130
6.2.4	The uniform infinite labeled tree . . . . .	135
6.2.5	The main result . . . . .	136
6.3	Geodesics in the UIPQ . . . . .	137
6.3.1	Confluent geodesics to the root . . . . .	137
6.3.2	Coalescence of proper geodesics rays to infinity . . . . .	139
6.3.3	End of the proof of Theorem 6.9 . . . . .	147
6.4	Applications . . . . .	148
6.4.1	Local limit <i>versus</i> scaling limit . . . . .	149
6.4.2	Random walk on the UIPQ . . . . .	153
<b>III</b>	<b>Racine de dix-sept moins trois sur deux</b>	<b>161</b>
<b>7</b>	<b>The Random Recursive Triangulation of the Disk <i>via</i> Fragmentation Theory</b>	<b>163</b>
7.1	Introduction . . . . .	163
7.2	Random geodesic laminations . . . . .	167
7.2.1	Laminations . . . . .	167
7.2.2	Figelas and associated trees . . . . .	168
7.2.3	Coding by continuous functions . . . . .	169
7.2.4	Random recursive laminations . . . . .	170
7.3	Random fragmentations . . . . .	172
7.3.1	Fragmentation theory . . . . .	172
7.3.2	The number of chords in the figela process . . . . .	174
7.3.3	Fragments separating 1 from a uniform point . . . . .	175
7.3.4	Fragments separating 1 from a deterministic point . . . . .	181
7.4	Estimates for moments and the continuity of the height process . . . . .	185
7.4.1	Estimates for moments . . . . .	185
7.4.2	The case $p = 1$ . . . . .	185
7.4.3	The case $p \geq 2$ . . . . .	187
7.4.4	Proof of Theorem 7.1 . . . . .	190
7.5	Identifying the limiting lamination . . . . .	191
7.5.1	Preliminaries . . . . .	191
7.5.2	Maximality of the limiting lamination . . . . .	193
7.6	The Hausdorff dimension of $L_\infty$ . . . . .	200
7.7	Convergence of discrete models . . . . .	202
7.8	Extensions and comments . . . . .	204
7.8.1	Case $\alpha = 0$ . . . . .	204
7.8.2	Recursive self-similarity . . . . .	205

<b>8</b>	<b>Random Laminations and Multitype Branching Processes</b>	<b>207</b>
8.1	Introduction . . . . .	207
8.2	The critical case . . . . .	210
8.2.1	A martingale . . . . .	210
8.2.2	The quasi-stationary distribution . . . . .	211
8.2.3	Proof of Theorem 9.6.2 . . . . .	213
8.3	Extensions . . . . .	216
<b>9</b>	<b>Partial Match Queries in Two-Dimensional Quadrees : A Probabilistic Approach.</b>	<b>221</b>
9.1	Introduction . . . . .	221
9.2	Notation and first properties . . . . .	222
9.2.1	The continuous-time model . . . . .	223
9.2.2	Main equations . . . . .	223
9.2.3	Depoissonization . . . . .	225
9.3	Particular cases and fragmentation theory . . . . .	225
9.3.1	The uniform case . . . . .	226
9.3.2	Case $x = 0$ . . . . .	228
9.3.3	An <i>a priori</i> uniform bound . . . . .	230
9.4	The convergence at fixed $x \in (0, 1)$ . . . . .	231
9.4.1	A key Markov chain . . . . .	231
9.4.2	Study of $t^{-\beta^*} 2^k \mathbb{E}[\tilde{N}_{\tilde{M}_k t - F_k}(X_k) \mathbf{1}_{T > k}]$ . . . . .	233
9.4.3	Conclusion . . . . .	235
9.5	Identifying the limit . . . . .	235
9.6	Extensions and comments . . . . .	237
9.6.1	Various convergences . . . . .	237
9.6.2	Multidimensional case . . . . .	237
9.6.3	Quadtree as a model of random geometry . . . . .	237



# PARTIE

---

## Introduction

16 figures, 20 photos  
et quelques blagues.

---

Cette partie introductive est divisée en deux chapitres, essentiellement disjoints, qui présentent les résultats principaux de cette thèse. Les contributions originales de ce travail correspondent aux travaux [16, 17, 46, 47, 48, 49, 50] et peuvent être trouvées aux chapitres 3-9, ou dans les Sections 1.2.4, 1.3.4, 1.3.5, 1.3.6, 2.2, et 2.3 de l'introduction. Elles sont signalées par des théorèmes ou propositions encadrés par deux lignes horizontales.

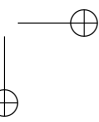
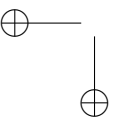
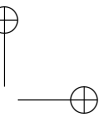
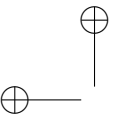

# Cartes planaires aléatoires

---

« Evitez les cartes car ce jeu peut nuire. »

## 1.1 Cartes planaires

### 1.1.1 Définition

Un graphe  $G$  est un couple formé de deux ensembles, un ensemble de sommets  $V$  et un ensemble d'arêtes  $E$ . Chaque arête a deux extrémités dans  $V$  éventuellement identiques. Ainsi les graphes considérés peuvent avoir des arêtes multiples ou des boucles. Un graphe sans arête multiple ou boucle est dit *simple*. Sans plus attendre, donnons la définition d'une carte planaire. Il existe de nombreuses définitions équivalentes mais présentons la plus « géométrique » :

**Définition 1.** Une carte planaire est un plongement propre d'un graphe (planaire) fini et connexe dans la sphère  $\mathbb{S}_2$ , considéré à homéomorphisme préservant l'orientation près.

L'adjectif planaire réfère à la sphère  $\mathbb{S}_2$  munie de son orientation. Il existe aussi une notion de carte de genre  $g \in \{0, 1, 2, \dots\}$  qui sont des plongements propres de graphes dans le tore à  $g$  trous, vus à homéomorphisme préservant l'orientation près. Cependant, dans ce travail, nous nous concentrerons sur le cas planaire  $g = 0$ .



Si  $m$  est une carte planaire, nous noterons respectivement  $V(m)$ ,  $E(m)$  et  $F(m)$  l'ensemble de ses sommets, arêtes et faces (voir [113] pour une définition rigoureuse). La célèbre formule d'Euler donne une relation très simple entre les cardinaux de ces ensembles dans le cas planaire :

$$\#V(m) + \#F(m) - \#E(m) = 2. \quad (1.1)$$

Le degré  $\deg(v)$  d'un sommet  $v \in V(m)$  est le nombre de demi-arêtes adjacentes à celui-ci et le degré  $\deg(f)$  d'une face  $f \in F(m)$  est le nombre d'arêtes la bordant, avec la convention qu'une arête complètement incluse dans une face compte double. On notera également  $d_{\text{gr}}^m(u, v)$  la distance de graphe entre deux sommets  $u, v \in V(m)$ , c'est-à-dire le nombre minimal d'arêtes d'un chemin reliant les deux points en question.

À la vue de la Définition 1, il n'est pas évident, *a priori*, qu'il n'existe qu'un nombre fini de cartes planaires avec  $n$  arêtes. Pour s'en convaincre, il faut se persuader qu'une

carte planaire peut-être caractérisée par sa structure de graphe, et par une orientation cohérente des arêtes autour de chaque sommet : c’est la définition par système de rotations (voir par exemple [93]). Une carte planaire contient donc plus d’informations que la structure de graphe planaire sous-jacente, et il est aisé de construire plusieurs cartes planaires différentes ayant la même structure de graphe.

**Symétries.** Il peut paraître saugrenu de considérer les cartes planaires au lieu des graphes planaires. Les cartes sont en effet des objets beaucoup plus rigides que les graphes, mais c’est justement cette rigidité qui va *énormément* faciliter l’énumération des cartes planaires<sup>1</sup>. Citons Gilles Schaeffer, [127, Introduction]

*« Paradoxalement en effet, les cartes, a priori plus complexes que les graphes, sont plus simples à bien des égards lorsqu’on s’intéresse à la planarité. Ce paradoxe n’en est d’ailleurs pas vraiment un, puisque les cartes planaires contiennent la description de leur planarité, par opposition aux graphes planaires, pour lesquels le plongement se contente d’exister. »*

Nous considérerons dans la suite uniquement des cartes *enracinées*, c’est-à-dire munies d’une arête orientée distinguée, appelée la « racine » de la carte. Une carte enracinée n’a alors aucune symétrie non triviale, voir [113, Proposition 1.1].

Une *triangulation* (resp. *quadrangulation*) est une carte planaire dont toutes les faces sont de degré trois (resp. quatre). L’ensemble des cartes planaires à  $n$  arêtes est naturellement en bijection avec l’ensemble des quadrangulations à  $n$  faces : dans chaque face d’une carte générale, placez un point que vous reliez aux sommets adjacents de la carte. La carte ainsi construite est une quadrangulation, et ses faces correspondent aux arêtes de la carte originale.

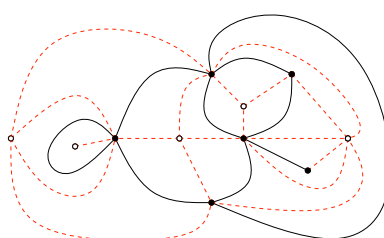

FIGURE 1.1 – Une carte générale et la quadrangulation associée.

---

1. L’énumération des graphes planaires, sujet très difficile, passe d’ailleurs par l’énumération des cartes planaires [73]. Le transfert graphe-carte utilise le théorème de Whitney qui stipule qu’un graphe planaire 3-connexe n’a au plus que deux cartes associées (se déduisant l’une de l’autre par réflexion dans  $\mathbb{S}_2$  autour de l’équateur).



### 1.1.2 A Census of Censuses of planar maps

Nous présentons dans cette section une esquisse de quelques méthodes « historiques » d'énumération des cartes planaires. Elles illustrent les nombreuses connections qu'elles entretiennent avec d'autres domaines des mathématiques et de la physique théorique. Nous n'avons pas la prétention de donner des preuves.

#### Combinatoire énumérative



Le premier à avoir véritablement initié l'étude des cartes planaires est William Thomas Tutte. Il décide dans les années 60 de lancer un vaste projet pour les dénombrer [139, 140, 141, 142]. Son but (non atteint) était de montrer le théorème des quatre couleurs en prouvant qu'il y a autant de cartes planaires 4-coloriables que de cartes planaires quelconques, voir [143]. Donnons une vue aérienne de la méthode. En vertu de la bijection présentée dans la section précédente (et qui s'étend aisément au cas enraciné), l'énumérateur voulant dénombrer les cartes planaires à  $n$  arêtes enracinées n'a besoin de compter que les quadrangulations enracinées à  $n$  faces. Pour cela, on utilise une décomposition récursive due à Tutte : l'effacement de la face à la droite de l'arête racine permet de passer de  $n$  à  $n - 1$  faces. Le problème est que lors de cette opération, la face « extérieure » de la carte obtenue n'est plus forcément un carré et la carte peut même être scindée en deux parties.

La solution consiste à considérer une classe plus générale de quadrangulations : les *quadrangulations à bord* où toutes les faces sont des carrés, hormis la face à gauche de l'arête racine qui peut être de degré arbitraire (mais pair). Ainsi, si  $F(x, y)$  est la fonction génératrice des quadrangulations à bord avec poids  $x$  par face et  $y$  par arête du bord,

$$F(x, y) = \sum_{\substack{\text{quadrangulations} \\ \text{à bord}}} x^{\#\text{faces}} y^{\#\text{arêtes du bord}},$$

cette décomposition récursive se traduit en une équation quadratique en  $F$ . Tutte développa une méthode, dite méthode quadratique, pour résoudre ces équations et engendra un nouveau champ de recherche en combinatoire énumérative, voir par exemple [31]. Il arriva ainsi à montrer que le nombre de quadrangulations enracinées à  $n$  faces est

$$q_n = \frac{2}{n+2} 3^n \frac{1}{n+1} \binom{2n}{n}. \tag{1.2}$$

#### Combinatoire Bijective

Dès la découverte de la formule (1.2), les combinatoriciens ont cherché une interprétation de l'apparition du  $n$ -ième nombre de Catalan,  $\text{Cat}(n) = \frac{1}{n+1} \binom{2n}{n}$ , dans l'énumération des cartes planaires. En effet, l'omnipotent  $\text{Cat}(n)$  compte beaucoup de familles

d’objets combinatoires, voir [136] pour 66 interprétations différentes des nombres de Catalan. La réponse de Cori et Vauquelin [45] vint beaucoup plus tard. Ils montrèrent que les cartes planaires peuvent être encodées par des objets beaucoup plus simples : des arbres étiquetés.

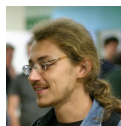

Mais c’est Gilles Schaeffer [127] qui popularise et rend ces bijections fonctionnelles (en particulier il montre que les étiquettes des arbres ont une signification métrique dans la carte associée). Nous ne décrivons pas ici le principe de ces bijections, qui sera détaillé en Section 1.2.1.

Modèle de matrice



Aussi surprenant que cela puisse paraître, les cartes planaires peuvent aussi être énumérées à l’aide d’intégrales matricielles. Cette idée remonte à ’t Hooft [138], puis a été développée dans [38] où l’on peut trouver l’étrange formule

$$\lim_{N \rightarrow \infty} \frac{1}{N^2} \log \left( \int dM \exp \left( N \left( -\frac{1}{2} \text{Tr}(M^2) + \frac{z}{4} \text{Tr}(M^4) \right) \right) \right) = \sum_{\substack{\text{cartes planaires} \\ \text{4-valentes}}} \frac{z^{\#\text{sommets}}}{\#\text{symétries}},$$

où  $dM$  représente la mesure de Lebesgue sur les matrices hermitiennes de taille  $N \times N$ . Rappelons qu’une carte planaire est 4-valente si tous ses sommets sont de degrés 4, ou de manière équivalente si elle représente le dual d’une quadrangulation. Le mystère s’éclaircit quelque peu si l’on arrive à se convaincre en utilisant la formule de Wick que les termes non nuls dans le développement de  $\mathbb{E} [\text{Tr}(M^4)^n]$  peuvent être représentés sous forme d’un diagramme, dit de Feynman, à  $n$  sommets. Voir [147] pour plus de détails.

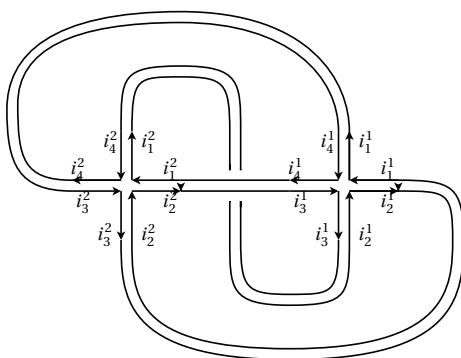

FIGURE 1.2 – Un diagramme de Feynman : une carte 4-valente de genre 1 avec 2 sommets. Les  $i_a^b$  pour  $a \in \{1, 2, 3, 4\}$  et  $b \in \{1, 2\}$  représentent des indices de variables gaussiennes composant la matrice  $H$ . Les indices doivent être couplés pour que l’espérance du terme considéré ne soit pas nulle.

Le nombre de termes dans  $\mathbb{E} [\text{Tr}(M^4)^n]$  représentés par un diagramme fixé (c’est-à-dire le nombre de degrés de liberté dans le choix des indices  $i_a^b, a \in \{1, 2, 3, 4\}, b \in \{1, 2\}$  vérifiant un couplage donné, comme dans la Fig.1.2) est  $N^{2-2g}$ , où  $g$  est le genre du diagramme (c’est une application de (1.1)). Attention,  $n$  représente le nombre de sommets du diagramme alors que  $N$  est la taille de matrice  $M$ . Les diagrammes dominants dans la limite  $N \rightarrow \infty$  sont donc les diagrammes planaires, et la formule précédente perd de son étrangeté.

Les physiciens ont alors développé des techniques très robustes de calcul d’intégrales matricielles permettant le comptage de nombreux modèles de cartes, voir [56].

### 1.1.3 Géométrie aléatoire

En plus de leur intérêt purement combinatoire et esthétique, les cartes planaires ont été considérées par certains physiciens comme modèle de géométrie aléatoire [9]. Leur motivation était d’étendre à la dimension deux les intégrales de chemins de Feynman, et ce, afin de développer la gravité quantique bidimensionnelle<sup>2</sup>. Sans vouloir (et pouvoir) entrer dans les considérations physiques de cette motivation, nous nous contenterons du point de vue probabiliste.

#### Limite d’échelle

Le but est de construire l’analogie du mouvement brownien en dimension deux. Prenons exemple sur le cas unidimensionnel : la loi du mouvement brownien sur  $[0, 1]$  est une mesure de probabilité sur les fonctions continues  $[0, 1] \rightarrow \mathbb{R}$ . Une manière de construire cette distribution passe par la discrétisation. On considère tout d’abord la loi uniforme sur les chemins discrets de pas  $\pm 1$  et de longueur  $n$ . Après une remise à l’échelle convenable, on peut montrer que les mesures de probabilité obtenues sur les courbes  $[0, 1] \rightarrow \mathbb{R}$  convergent faiblement vers la loi du mouvement brownien sur  $[0, 1]$  quand  $n \rightarrow \infty$  (c’est le théorème de Donsker).

Le rôle du chemin discret uniforme de taille  $n$  dans le cas bidimensionnel est joué par une quadrangulation uniforme à  $n$  faces. Ainsi, la carte aléatoire finie est une discrétisation d’une surface topologique aléatoire de dimension deux, tout comme le chemin discret est une discrétisation du mouvement brownien.

La construction de cette surface aléatoire, *la carte brownienne* [98, 110], n’est pas encore totalement achevée, voir Section 1.2.3. Elle est supputée être universelle, au sens où de nombreux modèles de grandes cartes planaires (triangulations, quadrangulations, pentagulations...) sont censés converger en distribution au sens de Gromov-Hausdorff (voir Section 1.2.3) vers cet objet.

---

2. impressionnant n’est ce pas ?

## Limite locale

Sans passer par le truchement d’une remise à l’échelle pour définir des objets continus, il est possible de donner un sens [11, 89] à la limite quand  $n \rightarrow \infty$  des triangulations ou quadrangulations uniformes de taille  $n$ . Cette convergence, dite *locale*, définit des objets limites qui ne sont plus des surfaces topologiques aléatoires mais des cartes infinies enracinées, voir Section 1.3, Chapitre 6 et [49].

### 1.1.4 Science Fiction

La gravité quantique est une théorie physique qui suggère un lien très profond entre géométrie aléatoire et géométrie déterministe. Des prédictions physiques [86] relient en effet les dimensions fractales de certains objets aléatoires (amas de percolation, de modèle d’Ising et autres systèmes de mécanique statistique) sur un réseau aléatoire et sur un réseau fixe. La formule magique est la suivante,

$$\Delta - \Delta_0 = \frac{\Delta(1 - \Delta)}{k + 2}, \quad (\text{KPZ})$$

où  $2 - 2\Delta$  est la dimension de l’objet fractal en géométrie aléatoire et  $2 - 2\Delta_0$  est la dimension correspondante en géométrie déterministe (réseau régulier). Le paramètre  $k$  est quant à lui spécifique du modèle de mécanique statistique considéré. De récents progrès sur ce front ont été obtenus en considérant une géométrie aléatoire définie à partir de cascades multiplicatives [22], ou à partir du champ libre gaussien [59]. Il est également conjecturé que les cartes planaires aléatoires sont un modèle de géométrie aléatoire à laquelle la formule (KPZ) devrait s’appliquer [15, 131]. Une conjecture mathématiquement précise utilisant les empilements de cercles (voir Section 1.3.3) peut être trouvée dans [15, Section 3.2]. À l’heure actuelle, tout ce champ reste grandement ouvert.

Après ce tour d’horizon des mille et une recettes pour énumérer les cartes planaires, et des fabuleux mais encore ténébreux liens qu’elles sont censées entretenir avec la gravité quantique, entrons dans le vif du sujet. Le reste de ce chapitre sur les cartes planaires est divisé en deux parties, la première concerne les limites d’échelle, la seconde traite des limites locales.

## 1.2 Limite d’échelle

Afin de simplifier l’exposition, nous nous restreindrons au cas des quadrangulations. Dans tout ce qui suit,  $Q_n$  est une quadrangulation enracinée choisie uniformément parmi les quadrangulations enracinées à  $n$  faces.

### 1.2.1 Description de la bijection Cori-Vauquelin-Schaeffer

L’outil principal pour l’étude des limites d’échelles de cartes planaires aléatoires est la bijection de Cori-Vauquelin-Schaeffer (CVS). La forme la plus simple de cette

bijection établit une correspondance entre, d’un côté, les quadrangulations enracinées et *pointées*, c’est-à-dire munies d’un sommet distingué  $\rho$ , et d’autre part, les arbres plans étiquetés. Nous utiliserons le formalisme des arbres plans introduit dans [97]. Un étiquetage d’un arbre  $\tau$  est une fonction  $\ell : \tau \longrightarrow \mathbb{Z}$  qui vérifie les propriétés suivantes :

- l’étiquette de la racine est nulle,  $\ell(\emptyset) = 0$ ,
- si  $u$  et  $v$  sont deux sommets voisins alors  $|\ell(u) - \ell(v)| \leq 1$ .

Remarquons qu’une fois l’arbre  $\tau$  fixé, se donner un étiquetage de  $\tau$  revient à se donner des étiquettes appartenant à  $\{+1, 0, -1\}$  portées par les arêtes de  $\tau$  qui représentent la variation des étiquettes des sommets le long de chaque arête. Il y a donc  $3^n \text{Cat}(n)$  arbres étiquetés différents avec  $n$  arêtes.

**Théorème** ([43, Theorem 4]). *Il y a une bijection entre les quadrangulations enracinées et pointées à  $n$  faces, et les couples formés d’un arbre étiqueté à  $n$  arêtes et d’un signe  $+$  ou  $-$ . Si  $\mathbf{q}$  est une quadrangulation enracinée et pointée associée à un couple  $((\tau, (\ell_u)_{u \in \tau}), \pm)$ , alors l’ensemble des sommets de la quadrangulation  $\mathbf{q}$  est formé par l’ensemble des sommets de l’arbre  $\tau$  et un sommet supplémentaire  $\rho$  qui est le sommet distingué de la carte. De plus, pour tout sommet  $u \in \tau$  (avec l’identification des sommets de l’arbre avec ceux de la carte différents de  $\rho$ ) on a*

$$\ell(u) - \min \ell + 1 = d_{\text{gr}}^{\mathbf{q}}(u, \rho), \tag{1.3}$$

où  $d_{\text{gr}}^{\mathbf{q}}(\cdot, \cdot)$  est la distance de graphe sur la quadrangulation  $\mathbf{q}$ .

**Remarque :** La formule d’Euler (1.1) implique que toute quadrangulation à  $n$  faces a exactement  $n + 2$  sommets. Ainsi le nombre de quadrangulations enracinées et pointées à  $n$  faces est exactement  $n + 2$  fois le nombre de quadrangulations enracinées à  $n$  faces. Puisqu’il y a  $3^n \text{Cat}(n)$  arbres étiquetés à  $n$  arêtes, le théorème précédent permet de (re-)déduire la formule de Tutte (1.2) sur le nombre de quadrangulations enracinées à  $n$  faces

$$q_n = \frac{2}{n+2} 3^n \frac{1}{n+1} \binom{2n}{n}.$$

Nous décrivons le fonctionnement de la bijection uniquement dans le sens partant des arbres étiquetés vers les quadrangulations, sens le plus utile pour nos applications. Nous renvoyons à [43, 127] pour les preuves. Soit  $(\tau, (\ell_u)_{u \in \tau})$  un arbre étiqueté. Rappelons que  $\tau$  est un arbre planaire, c’est-à-dire qu’il est muni d’une racine et d’une orientation. On considère un plongement de  $\tau$  dans le plan (avec des arêtes rectilignes pour simplifier) qui respecte l’orientation de  $\tau$ . Un *coin* de ce plongement est un secteur angulaire formé par deux arêtes adjacentes. On peut alors vérifier que ce plongement a  $2n$  coins si  $\tau$  a  $n$  arêtes. On définit le *contour* du plongement de  $\tau$  dans le sens des aiguilles d’une montre : on imagine que notre plongement est un mur et on le parcourt en plaquant sa main droite sur le mur et en avançant. Ce contour munit l’ensemble des coins d’une structure cyclique. La règle pour construire la quadrangulation associée à  $(\tau, (\ell_u)_{u \in \tau})$  est la suivante :

Chaque coin associé à un sommet d’étiquette  $i$  est relié au premier coin dans la suite du contour d’étiquette  $i - 1$ .

Attention toutefois, cette règle ne peut pas être appliquée aux coins associés aux sommets d’étiquette minimale. Tous ces coins sont alors reliés à un sommet supplémentaire, placé en dehors du plongement de  $\tau$  que l’on note  $\rho$ . Il est possible de dessiner toutes ces arêtes sans croisement, et après effacement du plongement de  $\tau$ , le résultat est un plongement d’une quadrangulation  $q$  à  $n$  faces. Le sommet distingué de  $q$  est  $\rho$  et l’arête racine est l’arête émergeant du coin racine de  $\tau$ , son orientation étant prescrite par le signe  $+$  ou  $-$  donné en plus de l’arbre étiqueté.

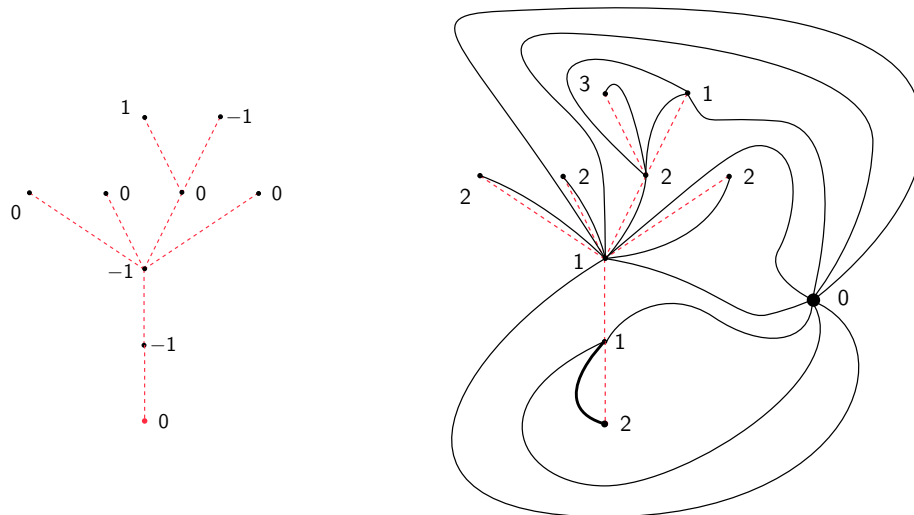

FIGURE 1.3 – Un arbre étiqueté et la quadrangulation associée. Notez que les étiquettes décalées par  $-\min \ell+1$  correspondent bien aux distances dans la carte depuis le sommet distingué.

### Bijection non pointée

Il existe une autre version de la bijection Cori-Vauquelin-Schaeffer qui établit une correspondance entre les quadrangulations enracinées à  $n$  faces (non pointées), et les arbres étiquetés à  $n$  arêtes vérifiant la propriété supplémentaire que les étiquettes doivent rester positives. Pour déduire cette bijection de la précédente, on se restreint au cas où le point distingué de la quadrangulation coïncide avec l’origine de l’arête racine. D’après la formule (1.3) les étiquettes sont automatiquement positives et il n’y a plus besoin d’un signe pour spécifier l’orientation de l’arête racine, voir [127] pour plus de détails.

L’avantage de cette bijection est que les étiquettes de l’arbre correspondent maintenant à la distance dans la carte (moins un) depuis l’origine de l’arête racine, et non depuis un sommet distingué. L’inconvénient est que les arbres mis en jeu ne sont plus uniformes sur les arbres plans, mais pondérés par leur structure [42, 101].

### Extensions



Bouttier, Di Francesco et Guitter ont étendu dans [32] la bijection précédente à toutes les cartes planaires sans restriction sur les degrés des faces. Les arbres étiquetés mis en jeu ont dans ce cas quatre types de sommets jouant des rôles différents, mais

le principe de la bijection est grosso-modo le même. Il est à noter toutefois que le cas des cartes biparties (où toutes les faces sont de degré pair) est plus maniable que le cas général, voir [109].

Ces bijections ont également été généralisées par Chapuy, Marcus et Schaeffer au cas des quadrangulations biparties de genre supérieur [41]. Les objets étiquetés ne sont plus des arbres mais des cartes à une face en genre  $g$  appelés  $g$ -arbres.

Plus récemment, Grégory Miermont a introduit dans [117] une bijection « multi-pointée » entre, d’une part, les quadrangulations avec  $p$  points distingués et  $n$  faces, et d’autre part, des cartes à  $p$  faces et  $n$  arêtes.

Ces bijections peuvent également être étendues à certaines quadrangulations infinies du plan. Chassaing et Durhuus ont introduit dans [42] une généralisation de la bijection non pointée pour construire l’UIPQ. La base du travail [49] consiste en une généralisation de la bijection pointée dans le cas de l’UIPQ. Voir 1.3.6.

#### 1.2.2 Rayon et profil



L’étude des limites d’échelle des cartes planaires a été lancée par l’article fondateur de Philippe Chassaing et Gilles Schaeffer : *Random Planar Lattices and Integrated SuperBrownian Excursion* [43]. Rappelons que  $Q_n$  est une quadrangulation enracinée uniforme à  $n$  faces. Notons  $v_0$  le sommet origine de l’arête racine de  $Q_n$ . Le rayon  $R_n$  de  $Q_n$  est par définition  $R_n = \max_v d_{\text{gr}}^{Q_n}(v_0, v)$ .

**Théorème** ([43, Corollary 3]). *On a la convergence en distribution*

$$n^{-1/4}R_n \xrightarrow[n \rightarrow \infty]{(d)} \left(\frac{8}{9}\right)^{1/4} \Delta, \tag{1.4}$$

où  $\Delta = \max Z - \min Z$ , et  $Z$  est la tête du serpent brownien de Le Gall dirigé par une excursion brownienne normalisée.

Chassaing & Schaeffer prouvent également que le profil vu de  $v_0$ , c’est-à-dire la mesure aléatoire sur  $\mathbb{R}_+$  qui rend compte des distances à  $v_0$  des sommets de la carte, converge, après renormalisation, vers la mesure aléatoire d’occupation de la tête du serpent (ISE), translatée afin que son minimum soit 0.

Introduisons succinctement ces objets qui nous seront utiles ultérieurement. Dans la suite  $(\mathbf{e}_t)_{0 \leq t \leq 1}$  désigne une excursion brownienne normalisée. Pour  $s, t \in [0, 1]$  on note

$$d_{\mathbf{e}}(s, t) = \mathbf{e}(s) + \mathbf{e}(t) - 2 \min_{[s \wedge t, s \vee t]} \mathbf{e}.$$



Le quotient de  $[0, 1]$  par la pseudo-distance  $d_{\mathbf{e}}$  est noté  $(\mathcal{T}_{\mathbf{e}}, d_{\mathbf{e}})$ , c’est le  $\mathbb{R}$ -arbre codé par  $\mathbf{e}$ , voir [97]. L’arbre aléatoire  $\mathcal{T}_{\mathbf{e}}$  n’est autre que le « Continuum Random Tree » (CRT) introduit et étudié par David Aldous dans les années 90 dans [2, 3, 4]. Conditionnellement à  $\mathbf{e}$ , on considère un mouvement brownien indexé par l’arbre  $\mathcal{T}_{\mathbf{e}}$ , c’est-à-dire un processus gaussien centré  $(Z_a)_{a \in \mathcal{T}_{\mathbf{e}}}$  dont la covariance est prescrite par

$$\mathbb{E}[(Z_a - Z_b)^2] = d_{\mathbf{e}}(a, b),$$

pour tous  $a, b \in \mathcal{T}_{\mathbf{e}}$ . Ce processus (en fait sa version indexée par  $[0, 1]$ ) est le serpent brownien dirigé par l’excursion  $\mathbf{e}$ . Nous renvoyons le lecteur intéressé vers [96] pour plus de détails.

Tentons d’expliquer intuitivement le théorème ci-dessus. Choisissons  $\mathbf{Q}_n$  une quadrangulation enracinée et pointée<sup>3</sup> uniforme à  $n$  faces, et notons  $(T_n, (\ell_u^n)_{u \in T_n})$  son arbre étiqueté associé par la bijection CVS. Alors l’arbre  $T_n$  est uniforme parmi les arbres planaires à  $n$  arêtes. Son étiquetage est également uniforme, c’est-à-dire que conditionnellement à  $T_n$ , les variations des étiquettes au travers de chaque arête sont indépendantes et uniformes sur  $\{-1, 0, +1\}$ . Le rayon de la carte  $\mathbf{Q}_n$  vu de  $\rho_n$  peut s’exprimer grâce à (1.3) comme

$$R'_n = \max_{v \in \mathbf{Q}_n} d_{\text{gr}}^{\mathbf{Q}_n}(\rho_n, v) = \max \ell^n - \min \ell^n + 1.$$

Aldous a montré [4] que les arbres  $T_n$  remormalisés par  $\sqrt{n}$ , c’est-à-dire en imaginant que chaque arête a longueur  $n^{-1/2}$ , convergent en distribution au sens de Gromov-Hausdorff (voir Section 1.2.3) vers un multiple de l’arbre continu  $\mathcal{T}_{\mathbf{e}}$ , voir aussi [97].

Puisque les étiquettes discrètes  $\ell^n$  varient comme des marches aléatoires le long de chaque branche de  $T_n$ , et comme la hauteur de  $T_n$  est de l’ordre de  $\sqrt{n}$ , il est naturel de penser que le processus  $(n^{-1/4} \ell_u^n)_{u \in T_n}$  converge vers un multiple du mouvement brownien  $(Z_a)_{a \in \mathcal{T}_{\mathbf{e}}}$ , indexé par l’arbre  $\mathcal{T}_{\mathbf{e}}$ . C’est effectivement le cas [43], ainsi  $n^{-1/4}(\max \ell^n - \min \ell^n) \rightarrow \kappa \Delta$  avec  $\Delta = \max Z - \min Z$  quand  $n \rightarrow \infty$ , pour une bonne constante  $\kappa > 0$ . On en déduit également  $n^{-1/4} R'_n \rightarrow \kappa \Delta$ .

Notons toutefois que cette dernière convergence a lieu pour un rayon  $R'_n$  vu du point  $\rho_n \in \mathbf{Q}_n$  qui n’est pas le même que le rayon  $R_n$  défini depuis l’origine  $v_0$  de l’arête racine de  $\mathbf{Q}_n$ , mais le résultat est le même. En un sens, le sommet distingué de  $\mathbf{Q}_n$  ou le sommet origine de l’arête racine de  $\mathbf{Q}_n$  sont deux sommets typiques et le profil de la carte vu de ces sommets a la même distribution asymptotique.

3. notez que dans le théorème on considère une quadrangulation  $Q_n$  non pointée qui peut être déduite de  $\mathbf{Q}_n$  après oubli du sommet distingué



### 1.2.3 Gromov-Hausdorff

Ces résultats sur le profil et le rayon des grandes quadrangulations aléatoires suggèrent l’existence d’une limite continue. Dans [110], Marckert et Mokkadem construisent à partir du couple  $(e, Z)$  une carte continue qu’ils nomment « the Brownian Map » et montrent la convergence des quadrangulations  $Q_n$  vers cet objet. Hélas, la topologie considérée, définie en termes de fonctions de contours, n’est pas pratique du point de vue métrique.

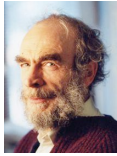

Il existe cependant une notion de convergence, la convergence au sens de Gromov-Hausdorff, très utilisée par les géomètres et qui capture beaucoup de propriétés métriques. Commençons par rappeler la définition de la distance de Hausdorff. Si  $A, B$  sont deux sous ensembles d’un espace métrique  $(E, d)$

alors la distance de Hausdorff entre  $A$  et  $B$  est

$$d_H^E(A, B) = \inf\{\varepsilon > 0, A \subset B^\varepsilon \text{ et } B \subset A^\varepsilon\},$$

où  $X^\varepsilon = \{y \in E, d(y, X) \leq \varepsilon\}$  est le  $\varepsilon$ -voisinage de l’ensemble  $X$ . Si maintenant  $(F, \delta)$  et  $(F', \delta')$  sont deux espaces métriques compacts abstraits, la distance de *Gromov-Hausdorff* entre eux est

$$d_{GH}((F, \delta), (F', \delta')) = \inf \left\{ d_H^E(\phi(F), \psi(F')) \right\}$$

où l’infimum est pris sur les tous les espaces métriques  $(E, d)$  et les plongements isométriques  $\phi : F \rightarrow E$  et  $\psi : F' \rightarrow E$ . Cette distance est effectivement une métrique sur l’espace  $\mathbb{K}$  des classes d’isométrie d’espaces métriques compacts [40, Chapitre 7]. En outre  $(\mathbb{K}, d_{GH})$  est un espace polonais. La convergence au sens de Gromov-Hausdorff a depuis été beaucoup utilisée en probabilités, notamment pour les convergences d’arbres aléatoires voir [1, 60, 64].

Si  $Q_n$  est une quadrangulation enracinée uniforme à  $n$  faces, l’ensemble de ses sommets  $V(Q_n)$  muni de la distance  $d_{gr}^{Q_n}(\cdot, \cdot)$  est un espace métrique compact. Après renormalisation par  $n^{-1/4}$ , le but est d’obtenir la convergence suivante

$$\text{BUT : } \left( V(Q_n), n^{-1/4} d_{gr}^{Q_n} \right) \xrightarrow[n \rightarrow \infty]{(d)} (\mathbb{M}, D), \tag{1.5}$$

en distribution au sens de la distance de Gromov-Hausdorff.



Cette approche a pour la première fois été proposée par Oded Schramm dans le cas des triangulations [129]. Les résultats les plus significatifs dans la direction de (1.5) ont été obtenus par Le Gall.

**Théorème** ([98, 102]). *De toute suite d’entiers tendant vers  $+\infty$ , on peut extraire une suite  $(n_k)_{k \geq 1}$  le long de laquelle la convergence (1.5) a lieu. L’espace métrique compact aléatoire  $(\mathbb{M}, \mathbb{D})$  peut alors dépendre de la sous-suite considérée, mais*

- $(\mathbb{M}, \mathbb{D})$  est presque sûrement de dimension de Hausdorff 4,
- $(\mathbb{M}, \mathbb{D})$  est presque sûrement homéomorphe à la sphère  $\mathbb{S}_2$ .

En d’autres termes, la convergence (1.5) n’est pas encore établie, mais un résultat de compacité [98] montre qu’il existe des limites  $(\mathbb{M}, \mathbb{D})$  le long de certaines sous-suites. De plus ces espaces aléatoires vérifient des propriétés communes, comme celles exposées dans le théorème précédent, voir également [48, 99, 117]. Pour prouver la convergence (1.5), il suffirait d’établir des caractéristiques suffisantes sur les limites  $(\mathbb{M}, \mathbb{D})$  pour identifier leur loi.

**!!! Dernières nouvelles !!!**

Après la rédaction de cette (introduction de) thèse, Jean-François Le Gall et Grégory Miermont ont indépendamment prouvé la convergence (1.5), voir [100, 118]. Les preuves sont différentes mais utilisent toutes deux des propriétés très fines des géodésiques dans la carte brownienne [99]. La convergence vers la carte brownienne est également valide dans une bien plus grande généralité que le cas des quadrangulations (voir [100]) et inclut par exemple celui des triangulations (validation de la conjecture de Schramm).

Extensions

Les convergences du rayon et du profil établies dans [43] ont depuis été généralisées à de nombreux modèles de cartes planaires comprenant par exemple les triangulations [109, 119]. Les preuves reposent sur des principes d’invariance pour des arbres de Galton-Watson multi-types étiquetés et sur l’utilisation des bijections étendues de [32].

Les résultats de Le Gall [98], et ceux de Le Gall et Paulin [102], ont également été récemment généralisés dans le cas des quadrangulations biparties en genre supérieur par Jérémie Bettinelli [27, 26].

1.2.4 Le cactus brownien (Chap. 3 ou [48])

*Les résultats présentés dans cette section et détaillés dans le Chapitre 3 sont tirés de [48] et ont été obtenus en collaboration avec **Jean-François Le Gall et Grégory Miermont**.*

Présentation

« *Le monde entier est un cactus* » [62]

L’idée géométrique du cactus consiste à représenter une carte planaire pointée, en forçant les sommets à être à une hauteur qui correspond à leur distance au sommet pointé (voir Fig. 1.4).

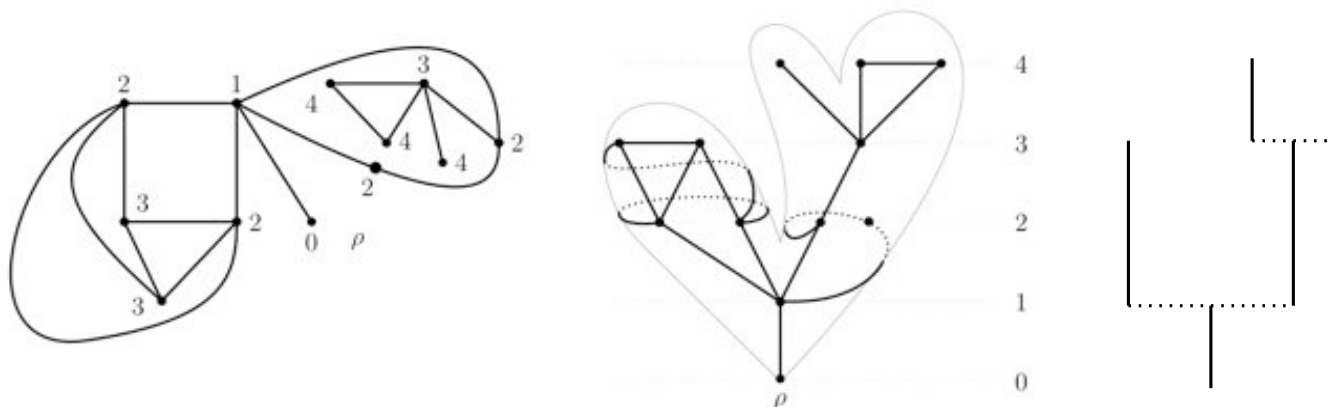

FIGURE 1.4 – Une carte plane pointée en  $\rho$  et sa représentation en « cactus »

On voit clairement une structure d’arbre émerger de cette représentation : imaginez que l’on contracte tous les cycles horizontaux de la figure centrale. Plus formellement, si  $\mathbf{G} = (G, \rho)$  est un graphe pointé (non nécessairement planaire), on définit une pseudo-distance sur  $V(G)$  par la formule

$$d_{\text{Cac}}^{\mathbf{G}}(a, b) = d_{\text{gr}}^G(\rho, a) + d_{\text{gr}}^G(\rho, b) - 2 \max_{\gamma: a \rightarrow b} d_{\text{gr}}^G(\rho, \gamma), \quad (1.6)$$

où le maximum est pris sur tous les chemins  $\gamma$  reliant  $a$  à  $b$  dans  $G$ , et  $d_{\text{gr}}^G(\rho, \gamma)$  représente la distance minimale entre un point du chemin  $\gamma$  et le point  $\rho$ . Le quotient de l’ensemble  $V(G)$  par cette pseudo-distance est un espace métrique qui a une structure d’arbre discret. Il est appelé cactus de  $\mathbf{G}$  et est noté  $\text{Cac}(\mathbf{G})$ . Notez que  $\text{Cac}(\mathbf{G})$  ne caractérise pas  $\mathbf{G}$  et dépend fortement du point de base  $\rho$ .

### Le cactus brownien

Si  $\mathbf{Q}_n$  est une quadrangulation enracinée et pointée uniforme à  $n$  faces, on notera  $\text{Cac}(\mathbf{Q}_n)$  le cactus du graphe de  $\mathbf{Q}_n$  pointé en le sommet distingué de la carte. Nous avons établi le résultat suivant.

### Théorème 2 ([48]).

On a la convergence en distribution au sens de Gromov-Hausdorff

$$n^{-1/4} \cdot \text{Cac}(\mathbf{Q}_n) \xrightarrow[n \rightarrow \infty]{(d)} \left(\frac{8}{9}\right)^{1/4} \text{KAC}, \quad (1.7)$$

où KAC est un  $\mathbb{R}$ -arbre aléatoire appelé cactus brownien.

**Remarque :** Malheureusement la convergence des cactus renormalisés associés à des grandes quadrangulations aléatoires ne permet pas d’en déduire la convergence (1.5). Cependant, notre résultat est valable dans une bien plus grande généralité [109, 114, 119] que le cadre des quadrangulations présenté ici, voir [48] ou Chapitre 3.

La preuve repose, bien entendu, sur des propriétés de la bijection CVS et de ses extensions. Notons  $(T_n, (\ell_u^n)_{u \in T_n})$  l'arbre associé à  $\mathbf{Q}_n$  par la bijection CVS. Si  $a, b \in \mathbf{Q}_n \setminus \{\rho_n\}$ , il est possible de « lire » approximativement la distance de cactus  $d_{\text{Cac}}^{\mathbf{Q}_n}(a, b)$  directement sur l'arbre étiqueté  $(T_n, (\ell_u^n)_{u \in T_n})$ , sans avoir à reconstruire la carte  $\mathbf{Q}_n$  :

$$\left| d_{\text{Cac}}^{\mathbf{Q}_n}(a, b) - (\ell_a^n + \ell_b^n - 2 \min_{[[a, b]]} \ell^n) \right| \leq 2,$$

où  $[[a, b]]$  est, avec l'identification des sommets de  $\mathbf{Q}_n \setminus \{\rho_n\}$  avec ceux de  $T_n$ , la géodésique discrète entre  $a$  et  $b$  dans  $T_n$ . Cette propriété passe à la limite, et donne une construction de l'arbre aléatoire KAC. On rappelle que  $(\mathcal{T}_e, (Z_a)_{a \in \mathcal{T}_e})$  est le CRT muni de son étiquetage brownien défini en Section 1.2.2. Si  $a, b \in \mathcal{T}_e$ , on note également  $[[a, b]]$  la géodésique dans  $\mathcal{T}_e$  entre  $a$  et  $b$ . La formule suivante définit une pseudo-distance sur  $\mathcal{T}_e$

$$d_{\text{KAC}}(a, b) = Z_a + Z_b - 2 \min_{c \in [[a, b]]} Z_c, \tag{1.8}$$

pour tout  $a, b \in \mathcal{T}_e$ . Le cactus brownien KAC est le quotient de  $\mathcal{T}_e$  pour la pseudo-distance  $d_{\text{KAC}}$ , il est muni de la distance quotient toujours notée  $d_{\text{KAC}}$ .

### Dimension de Hausdorff

Munis de la description du cactus brownien comme quotient du CRT par une relation d'équivalence basée sur son étiquetage brownien, il nous est maintenant possible de faire des calculs reliés à sa dimension de Hausdorff. Le cactus KAC possède une mesure aléatoire notée  $\mu$ , qui provient de la projection de la mesure  $\text{Leb}[0, 1]$  sur l'arbre brownien  $\mathcal{T}_e$ , puis sur KAC. Si  $B_{\text{KAC}}(x, \delta)$  est la boule dans le cactus brownien autour de  $x$  et de rayon  $\delta > 0$  pour la distance  $d_{\text{KAC}}$  on a les estimées suivantes :

**Proposition 3** ([48]).

(i) On a

$$\mathbb{E} \left[ \int_{\text{KAC}} \mu(dx) \mu(B_{\text{KAC}}(x, \delta)) \right] = \frac{2^{5/4} \Gamma(1/4)}{3\sqrt{\pi}} \delta^3 + o(\delta^3),$$

quand  $\delta \rightarrow 0$ .

(ii) Pour tout  $\varepsilon > 0$ ,

$$\limsup_{\delta \rightarrow 0} \frac{\mu(B_{\text{KAC}}(x, \delta))}{\delta^{4-\varepsilon}} = 0, \quad \mu(dx) \text{ p.p., p.s.}$$

En particulier, la seconde assertion de la proposition implique à l'aide de résultats standards que la dimension de Hausdorff de  $(\text{KAC}, d_{\text{KAC}})$  est presque sûrement plus grande que 4. On peut également montrer la borne supérieure associée<sup>4</sup>, voir Chapitre 3 ou [48].

4. cette borne supérieure provient essentiellement du caractère  $1/4 - \varepsilon$  Höldérien de la tête du serpent brownien  $Z$ , pour tout  $\varepsilon > 0$

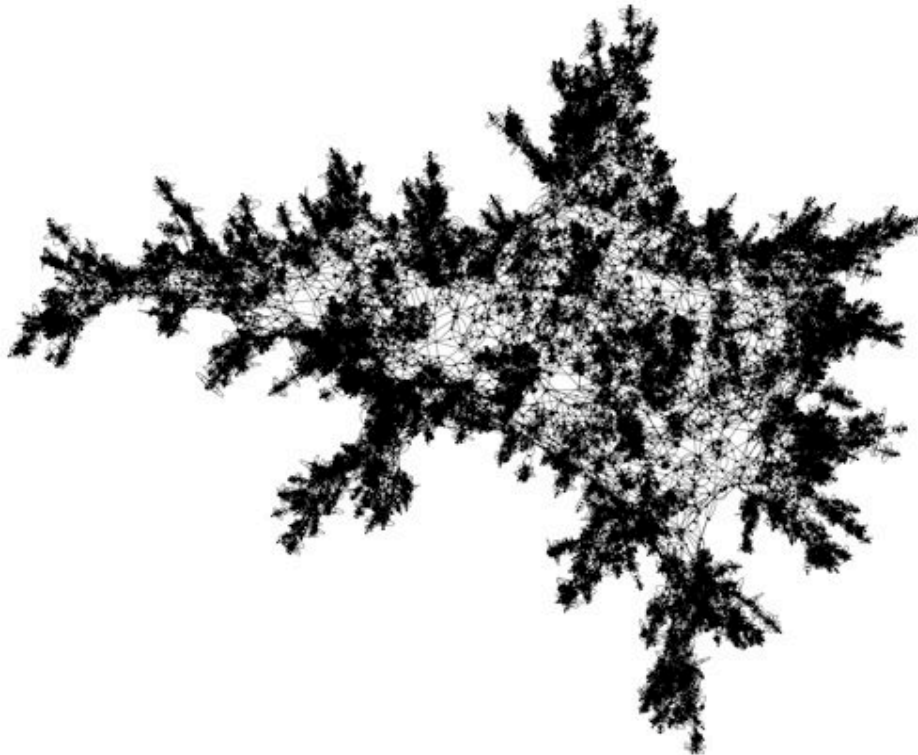

FIGURE 1.5 – Une grande quadrangulation aléatoire. Image réalisée par Jean-François Marckert.

Cela ne manque pas de piquant ! Un phénomène inhabituel apparaît dans le cactus brownien : si l’on fixe  $\delta > 0$ , l’espérance du volume d’une boule typique de rayon  $\delta$  est de l’ordre de  $\delta^3$ , alors que dans le cas de la carte brownienne cette quantité est de l’ordre de  $\delta^4$  [98]. Ainsi, l’identification des points opérée dans le cactus fait grossir l’espérance du volume d’une boule typique de rayon  $\delta$  ; normal me-direz-vous...

En revanche, pour presque tout point  $x$  tiré selon  $\mu(dx)$ , le volume de  $B_{\text{KAC}}(x, \delta)$  est asymptotiquement au plus de l’ordre de  $\delta^{4-\varepsilon}$  quand  $\delta \rightarrow 0$ , c’est le même ordre de grandeur que dans le cas de la carte brownienne [98].

Ceci s’explique intuitivement : la carte brownienne est hérissée de pics<sup>5</sup> et un point typique se trouve au sommet de l’un d’eux (voir Fig. 1.5). De plus, l’opération de passage au cactus identifie de moins en moins de points à mesure que l’on zoome autour du sommet de ce pic. Ainsi les volumes des boules microscopiques au voisinage de points typiques sont approximativement les mêmes dans le cactus et dans la carte brownienne.

---

5. aïe aïe aïe, ouille !

### Cycle séparateur

Une autre propriété géométrique de la carte brownienne s’inspirant de la représentation en cactus est l’existence de cycles séparateurs. Présentons le problème sans formalisme mais à l’aide d’un dessin. Imaginez une très grande quadrangulation enracinée avec trois points distingués uniformes. Alors, asymptotiquement, il n’existe essentiellement qu’un chemin de longueur minimale (dans la limite d’échelle) qui sépare les deuxième et troisième points tout en passant par le premier. Ceci n’est pas du tout évident et découle des résultats de Le Gall sur les géodésiques dans la carte brownienne [99]. Voir Fig. 1.6.

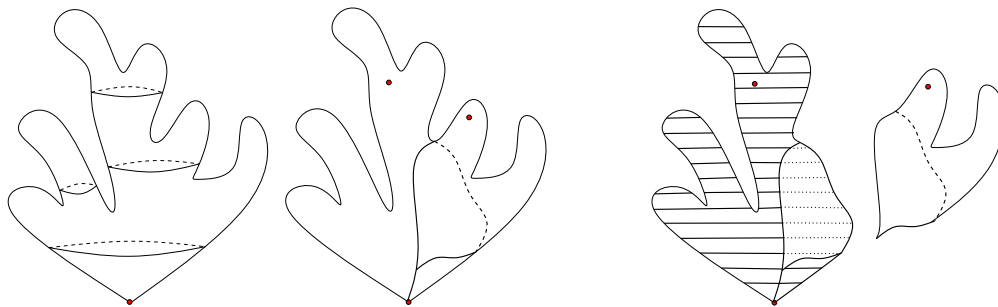

FIGURE 1.6 – Une grande quadrangulation avec trois points distingués. Le premier est utilisé pour la représentation « en cactus » de la carte. Sur la deuxième et troisième figure on voit le cycle minimal séparant et le découpage de la carte le long de ce cycle.

On peut caractériser ce cycle séparant et calculer la loi du couple des masses<sup>6</sup>  $(M_1, M_2)$  des deux composantes découpées par ce cycle.

**Théorème 4** ([48]).

Le couple  $(M_1, M_2)$  suit une loi Gamma de paramètres  $(\frac{1}{4}, \frac{1}{4})$ , c’est-à-dire

$$\mathbb{E}[f(M_1, M_2)] = \frac{\Gamma(1/2)}{\Gamma(1/4)^2} \int_0^1 dt (t(1-t))^{-3/4} f(t, 1-t),$$

pour toute fonction borélienne positive  $f$  sur  $\mathbb{R}_+^2$ .

**Remarque :** Dans le cas des quadrangulations, ce résultat a été obtenu auparavant par J. Bouttier et E. Guitter [34], avec des méthodes différentes.

6. c’est-à-dire la fraction asymptotique des sommets

### 1.3 Limite locale

Dans la partie précédente, nous avons étudié les limites d'échelle de quadrangulations aléatoires. Cette partie se focalise sur les limites dites locales. Avec ce type de convergence, on ne renormalise plus les cartes considérées et les objets limites sont des cartes infinies. Ici aussi, nous nous en tiendrons aux quadrangulations pour faciliter l'exposition.

#### 1.3.1 Convergence

Notons  $\mathcal{Q}_f$  l'ensemble des quadrangulations finies enracinées. Soit  $q \in \mathcal{Q}_f$ . La *boule de rayon  $r$  dans  $q$* , notée  $\text{Ball}(q, r)$ , est la carte enracinée formée par l'ensemble des faces de  $q$  qui comportent un sommet à distance au plus  $r$  de l'origine de l'arête racine de  $q$ . Notez que  $\text{Ball}(q, r)$  n'est pas une quadrangulation en général : certaines faces correspondent à des « trous », c'est-à-dire à un ensemble connexe de faces de  $q \setminus \text{Ball}(q, r)$ .

**Définition 5.** La distance locale entre deux quadrangulations  $q, q' \in \mathcal{Q}_f$  est

$$d_{\text{loc}}(q, q') = (1 + \sup \{r \geq 0 : \text{Ball}(q, r) = \text{Ball}(q', r)\})^{-1}.$$

Il est facile de vérifier que  $d_{\text{loc}}$  est bien une distance sur  $\mathcal{Q}_f$ , mais  $(\mathcal{Q}_f, d_{\text{loc}})$  n'est pas complet. Son complété est noté  $\mathcal{Q}$ , et les éléments de  $\mathcal{Q} \setminus \mathcal{Q}_f$  sont appelés *cartes infinies*. Une carte infinie  $q$  peut être décrite par la suite de ses boules  $q_i = \text{Ball}(q, i)$  qui possèdent la propriété de cohérence  $\text{Ball}(q_i, j) = q_j$  pour  $j \leq i$ .

On rappelle que  $Q_n$  est une quadrangulation enracinée uniforme à  $n$  faces.

**Théorème** ([89]). On a la convergence en distribution au sens de  $d_{\text{loc}}$



$$Q_n \xrightarrow[n \rightarrow \infty]{(d)} Q_\infty,$$

où  $Q_\infty$  est une quadrangulation enracinée infinie aléatoire appelée la quadrangulation infinie uniforme du plan ( $\text{UIPQ}^a$ ).

a. pour Uniform Infinite Planar Quadrangulation



Un travail pionnier avait été réalisé auparavant par Omer Angel et Oded Schramm [11]. Ils ont défini un objet analogue dans le cas des triangulations : l'UIPT<sup>7</sup>. Leur preuve reposait sur des formules énumératives exactes obtenues par Tutte dans le cas des triangulations. Bien qu'une approche similaire soit possible dans le cas des quadrangulations, Maxim Krikun a utilisé des arguments quelque peu différents pour définir l'UIPQ. Il est conjecturé que les propriétés à grande échelle de l'UIPT ou de l'UIPQ sont les mêmes.

7. pour Uniform Infinite Planar Triangulation

### 1.3.2 Petit Historique

L’UIPT et l’UIPQ ont été les objets de nombreuses recherches. Tentons de faire l’état de l’art sur le sujet.

L’étude des limites locales de graphes planaires a été initiée par l’article fondateur d’Itai Benjamini et Oded Schramm [21] que nous détaillerons en Section 1.3.3 . La convergence locale des triangulations uniformes du plan était une question laissée ouverte dans cet article...



I. Benjamini  
en taste-andouille

Elle ne le resta pas longtemps : dans [11] Angel & Schramm définissent l’UIPT comme la limite locale de grandes triangulations uniformes. Ils établissent également les propriétés élémentaires de cet objet, en particulier ils montrent que l’UIPT n’a qu’un seul bout et possède une propriété de Markov spatiale<sup>8</sup>.

Dans [10], Omer Angel s’inspire du peeling<sup>9</sup> introduit par le physicien Watabiki [146] pour explorer de façon markovienne l’UIPT. Il montre par exemple que le volume de la boule de rayon  $r \geq 0$  autour de la racine dans l’UIPT croît comme  $r^4$ , à corrections logarithmiques près. L’exposant 4 qui intervient ici est très intimement lié à l’exposant  $1/4$  intervenant dans le théorème de Chassaing et Schaeffer<sup>10</sup>. Cette technique a également été utilisée par le même auteur pour prouver que le paramètre critique de la percolation par site sur l’UIPT est  $p_c = 1/2$ .

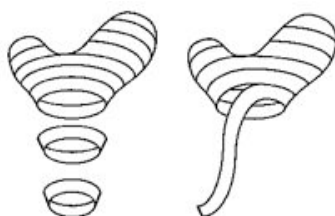

FIGURE 1.7 – Illustration de la technique de peeling. Images tirées de [146].

Poursuivant la voie ouverte dans [11], Maxim Krikun définit dans [89] l’UIPQ comme la limite locale des grandes quadrangulations uniformes. Son approche, bien que similaire à celle de [11], diffère sur quelques points. Par exemple, la définition de l’UIPQ passe par l’étude de son « squelette » (il étudia auparavant le squelette de l’UIPT dans

8. grosso-modo, étant donné un voisinage de l’origine dans l’UIPT, conditionnellement à la taille des frontières de ce voisinage, le reste de la triangulation est indépendant

9. épluchage

10. La bijection CVS et la technique du peeling sont, à l’heure actuelle, les deux seuls moyens pour prouver que les distances dans une quadrangulation de taille  $n$  sont de l’ordre de  $n^{1/4}$ .



[91]). Krikun est également l’auteur de l’article [90] dans lequel il établit une propriété des distances dans l’UIPQ « vue de l’infini » et propose quelques conjectures qui motiveront notre approche [49].



Parallèlement, Chassaing et Durhuus [42] ont introduit une quadrangulation infinie aléatoire *a priori* différente de l’UIPQ. Pour ce faire, ils prouvent d’abord que la distribution sur les arbres étiquetés positifs à  $n$  arêtes, associée à la probabilité uniforme sur  $\mathcal{Q}_n$  par la bijection CVS non pointée vue en Section 1.2.1 admet une limite locale (en un sens similaire à  $d_{\text{loc}}$ ) quand  $n \rightarrow \infty$ . Ils définissent ainsi un arbre aléatoire infini avec étiquettes positives et étendent la bijection CVS à cet objet pour créer une quadrangulation infinie. Ils établissent que l’espérance du volume de la boule de rayon  $r$  autour de la racine dans cette quadrangulation est de l’ordre de  $r^4$  quand  $r$  est grand.

Plus tard, Laurent Ménard [111] montre que l’objet défini par Chassaing et Durhuus est effectivement le même que l’UIPQ introduite par Krikun. Enfin, récemment, Le Gall et Ménard ont précisé les résultats sur le volume des boules (convergence en loi après renormalisation) en étudiant des limites d’échelle de l’UIPQ *via* l’approche de Chassaing et Durhuus.

Une irréductible question...

Beaucoup d’informations géométriques sont disponibles sur l’UIPQ ou son alter-ego l’UIPT. Néanmoins une question essentielle reste encore et toujours ouverte :

**Question 1.** *La marche aléatoire simple sur l’UIPQ (ou UIPT) est-elle p.s. transiente ou récurrente ?*

Il a été conjecturé dans [11] que l’UIPT est presque sûrement récurrente. Cette conjecture est fortement supportée par le résultat [21], le très récent travail [72] et le fait que l’UIPQ est presque sûrement Liouville [17] (ou Section 1.3.5 et Chapitre 5). Néanmoins, toutes ces techniques butent sur **un** écueil pour prouver la récurrence : les degrés des sommets ne sont pas uniformément bornés dans l’UIPT/Q.

### 1.3.3 L’approche de Benjamini et Schramm

Nous décrivons ici informellement le résultat principal de [21] avec quelques modifications pour alléger notre présentation. Commençons par une notion centrale :

**Définition 6.** *Soit  $M$  une carte planaire enracinée presque sûrement finie. Conditionnellement à  $M$ , soit  $\vec{E}$  une arête orientée choisie uniformément parmi les arêtes orientées de  $M$ . Si la carte  $\tilde{M}$  obtenue en ré-enracinant  $M$  en  $\vec{E}$  a la même distribution que  $M$ , on dit que  $M$  est uniformément enracinée.*

Par exemple, une quadrangulation enracinée à  $n$  faces uniforme est uniformément enracinée. Le théorème suivant est une légère adaptation du théorème principal de [21].

**Théorème.** Soit  $(M_n)_{n \geq 0}$  une suite de cartes planaires aléatoires uniformément enracinées. On suppose que

- (i) il existe un entier  $d > 0$ , tel que pour tout  $n \geq 0$ , le degré maximal d'un sommet de  $M_n$  est borné par  $d$ ,
- (ii) les cartes  $M_n$  n'ont pas de boucles ni d'arêtes multiples,
- (iii) la suite  $(M_n)_{n \geq 0}$  converge en loi pour  $d_{\text{loc}}$  vers une carte aléatoire enracinée infinie  $M_\infty$ .

Alors  $M_\infty$  est presque sûrement récurrente pour la marche aléatoire simple.

La raison principale pour laquelle ce théorème ne peut pas s'appliquer (ou s'adapter) à l'UIPQ/T, est l'absence de la condition (i) dans le cas des quadrangulations/triangulations uniformes. La preuve de ce théorème est très originale et mérite quelques explications. À son cœur réside la théorie des empilements de cercles.

### Empilement de cercles

Un empilement de cercles  $\mathcal{P}$  est une collection de cercles du plan  $\mathbb{C}$  dont les disques sont d'intérieurs disjoints. On associe à  $\mathcal{P}$  un graphe, appelé *graphe de tangence*, dont les sommets sont les centres des cercles de  $\mathcal{P}$  et les arêtes correspondent à des cercles tangents, voir Fig. 1.8.

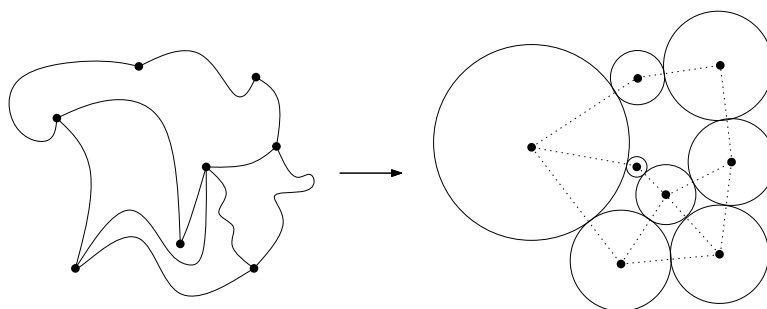

FIGURE 1.8 – Un graphe planaire et sa représentation en tant que graphe de tangence d'un empilement de cercles.

Le graphe obtenu est clairement planaire et n'a pas de boucles ni d'arêtes multiples (le graphe est dit *simple*). La réciproque est beaucoup plus surprenante et a été prouvée par Koebe puis redécouverte par Thurston comme un corollaire des travaux d'Andreev.

**Théorème** (Koebe-Andreev-Thurston). *Tout graphe planaire fini simple peut être représenté comme graphe de tangence d'un empilement de cercles*<sup>11</sup>.

On en déduit par exemple que tout graphe planaire simple peut être dessiné dans le plan avec des arêtes droites (théorème de Fáry). Nous renvoyons le lecteur intéressé

11. Si de plus le graphe est une triangulation, alors l'empilement de cercles est unique à transformation de Möbius près!

par ce magnifique sujet à l’excellent article de survol [126] ou au livre [137]. Le théorème précédent peut être généralisé à des graphes planaires infinis où une dichotomie apparaît. Le *support* d’un empilement  $\mathcal{P}$  est l’union des disques associés aux cercles de  $\mathcal{P}$  et des interstices entre ces disques.

**Théorème** ([77]). *Soit  $T$  une triangulation infinie du plan. Alors, de deux choses l’une :*

1. *soit il existe un empilement de cercles  $\mathcal{P}$  de support  $\mathbb{D}$  dont le graphe de tangence est  $T$ ,*
2. *soit il existe un empilement de cercles  $\mathcal{P}$  de support  $\mathbb{C}$  dont le graphe de tangence est  $T$ .*

Dans le premier cas, on dit que la triangulation  $T$  est hyperbolique, et parabolique dans le second. À beaucoup d’égards, ce théorème peut être considéré comme un analogue du théorème d’uniformisation pour les surfaces de Riemann. Par exemple, sous l’hypothèse d’une borne uniforme sur les degrés des sommets du graphe, parabolicité est équivalente à récurrence pour la marche aléatoire simple<sup>12</sup>. Ce lien profond [77] entre empilements de cercles et récurrence/transience de la marche aléatoire est la charnière de [21] : il « suffit » de montrer que des limites au sens de  $d_{\text{loc}}$  de cartes planaires *uniformément enracinées* sont paraboliques. Ceci est loin d’être trivial et repose essentiellement sur la notion d’enracinement uniforme [21, Lemma 2.3].

### 1.3.4 Dimension supérieure (Chap. 4 ou [16])

*Les résultats présentés dans cette section et détaillés dans le Chapitre 4 sont tirés de [16] et ont été obtenus en collaboration avec **Itai Benjamini**.*

Les graphes planaires sont exceptionnels<sup>13</sup> et la théorie analogue en dimension plus grande que trois est un sujet de recherche actuellement grandement ouvert. Par exemple, un des problèmes majeur consiste à prouver que le nombre de tétraèdrangulations 3D (un simplexe de dimension trois homéomorphe à la sphère  $\mathbb{S}_3$  de  $\mathbb{R}^4$ , dont tous les facettes sont des triangles et les simplexes de dimension trois des tétraèdres) à  $n$  arêtes croît au plus exponentiellement avec  $n$ , voir [14]. Cependant nous avons réussi à généraliser le résultat de [21] aux dimensions supérieures. Le théorème de Koebe–Andreev–Thurston n’étant disponible que dans le cas planaire, nous avons dû nous restreindre à des graphes dont on sait qu’il existe une représentation comme graphe de tangence d’un empilement de sphères en dimension  $d$ .

En outre, la connexion qui existe en dimension deux entre empilements de cercles et marches aléatoires se fait au travers de la théorie du potentiel  $\ell^2$  sur le graphe. La généralisation de cette théorie en dimension supérieure, la théorie du potentiel  $\ell^d$ , n’a pas d’interprétation probabiliste aussi claire. Notre résultat principal n’est donc pas

12. C’est ici que l’hypothèse de degrés bornés devient essentielle : il existe des triangulations paraboliques mais transientes pour la marche aléatoire simple [77, Theorem 8.2].

13. Voir par exemple l’article “Why are planar graphs so exceptional?” sur mathoverflow : <http://mathoverflow.net/questions/7114/why-are-planar-graphs-so-exceptional>

facile à exprimer sans introduire de notations et nous préférons plutôt donner un de ses corollaires géométriques :

**Corollaire 7** ([16]).

Soit  $G$  le graphe de tangence d'un empilement de sphères  $M$ -uniforme dans  $\mathbb{R}^d$ . On suppose que  $G$  est infini, on a alors l'alternative suivante :

- soit  $G$  a une constante de Cheeger positive i.e.

$$\inf_{A \subset G} \left\{ \frac{|\partial A|}{|A|}, A \subset G, |A| < \infty \right\} > 0$$

- soit, pour tout  $\varepsilon > 0$ , il existe des sous-graphes  $W$  de  $G$  de taille arbitrairement grande tels que

$$|\partial W| \leq |W|^{\frac{d-1}{d} + \varepsilon}.$$

La condition  $M$ -uniforme est une condition locale de l'empilement de sphères, qui stipule que deux sphères tangentes ont un rapport de rayons plus petit que  $M > 0$ .

### 1.3.5 Invariance de long de la marche aléatoire (Chap. 5 ou [17])

*Les résultats présentés dans cette section et détaillés dans le Chapitre 5 sont tirés de [17] et ont été obtenus en collaboration avec **Itai Benjamini**.*

Dans cette partie, la planarité ne joue plus aucun rôle. Les objets que nous considérerons seront des graphes enracinés (avec une arête orientée distinguée). En particulier, on étend (aisément) les Définitions 5 et 6 au cas des graphes enracinés. On conservera la notation  $d_{\text{loc}}$  pour la métrique de la convergence locale de graphes enracinés.

#### Graphes Stationnaires

Soit  $G$  un graphe aléatoire enraciné. Conditionnellement à  $G$ , on considère une marche aléatoire simple démarrant de l'extrémité de l'arête racine, et on note  $(\vec{E}_i)_{i \geq 1}$  les arêtes orientées traversées par la marche aléatoire<sup>14</sup>.

**Définition 8.** *Un graphe aléatoire enraciné  $G$  est dit stationnaire si pour tout  $i \geq 1$ , le graphe  $G$  re-enraciné en  $\vec{E}_i$  a la même loi que le graphe  $G$ .*

En particulier, tout graphe transitif enraciné en n'importe quelle arête orientée est stationnaire. Un exemple un peu moins trivial est donné par les graphes aléatoires uniformément enracinés. Il est également facile de voir que si  $(G_n)$  est une suite de graphes aléatoires enracinés et stationnaires, convergeant vers  $G$  pour  $d_{\text{loc}}$ , alors  $G$  est également stationnaire. *En particulier, le graphe enraciné obtenu en oubliant la structure planaire de l'UIPQ ou de l'UIPT est stationnaire.* C'est une propriété clé de l'UIPT/Q qui a déjà été utilisée à maintes reprises [11, 49, 90].

14. on imagine que la marche aléatoire traverse les arêtes du graphe, car on rappelle que les graphes peuvent avoir des arêtes multiples et des boucles

**Théorème 9** ([17]).

Soit  $G$  un graphe aléatoire stationnaire de croissance sous-exponentielle, c'est-à-dire,

$$n^{-1} \mathbb{E} [\log (\# \text{Ball}(G, n))] \xrightarrow{n \rightarrow \infty} 0,$$

où  $\# \text{Ball}(G, r)$  est le nombre de sommets à distance plus petite que  $r$  de l'origine de la racine dans  $G$ . Alors  $G$  est presque sûrement Liouville.

On rappelle qu'un graphe est dit Liouville s'il n'admet pas de fonction harmonique bornée non-constante. La preuve repose sur l'utilisation de la notion d'entropie de la marche aléatoire [13, 83]. Le théorème précédent est très robuste et permet, par exemple, de prouver le corollaire suivant.

**Corollaire 10** ([17]).

$L'UIPQ$  est presque sûrement Liouville.

**Remarque :** On peut se demander si l'ajout de la planarité du graphe dans les hypothèses du Théorème 9 permet de prouver la récurrence du graphe aléatoire stationnaire? Il n'en est rien et nous construisons dans [17] un exemple de graphe stationnaire, planaire, de croissance sous-exponentielle mais transient<sup>15</sup>. Ce graphe n'est bien entendu pas de degré borné [21].

**Graphes réversibles**

Un graphe aléatoire enraciné  $G$  est dit *réversible* si il est stationnaire et si le graphe  $\mathfrak{D}$  obtenu à partir de  $G$  en retournant l'arête racine a la même loi que  $G$ . Il existe des graphes stationnaires mais non réversibles, le plus connu est probablement le graphe du grand-père, voir Fig. 1.9

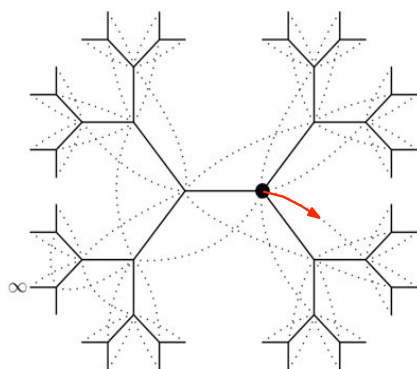

FIGURE 1.9 – Le graphe du grand-père est obtenu de la façon suivante. On démarre avec un arbre ternaire complet (lignes pleines) puis l'on choisit une branche infinie donnant une direction «  $\infty$  » au graphe; on ajoute ensuite toutes les arêtes entre petits-fils et grand-pères à l'arbre (lignes pointillées). Pour l'enraciner de façon aléatoire, on commence par choisir un point (le graphe est transitif) puis une arête orientée uniforme parmi les 8 arêtes pointant depuis ce sommet. Avec probabilité  $3/4$  l'arête orientée s'éloigne de l' $\infty$ , donc le graphe n'est pas réversible.

Le graphe du grand-père est à croissance exponentielle. Nous avons montré que cela est nécessaire pour avoir un graphe non-réversible :

15. Merci à Omer Angel pour la discussion qui a conduit à ce contre-exemple!

**Théorème 11** ([17]).

Soit  $G$  un graphe aléatoire enraciné stationnaire de degré presque sûrement borné et de croissance sous-exponentielle (au sens du théorème précédent) alors  $G$  est également réversible.

La notion de graphe stationnaire (et réversible) est reliée à beaucoup de concepts, comme la théorie ergodique [54], le « Mass–Transport–Principle » [7, 18] ou les relations d’équivalences mesurées discrètes [122]. Par exemple, pour prouver le théorème précédent nous avons emprunté et ré-interprété une notion très connue dans la théorie des relations d’équivalence mesurées : le cocycle de Radon-Nikodym.

1.3.6 L’UIPQ vue de l’infini (Chap. 6 ou [49])

*Les résultats présentés dans cette section et détaillés dans le Chapitre 6 sont tirés de [49] et ont été obtenus en collaboration avec **Laurent Ménard** et **Grégory Miermont**.*

**À lire avant utilisation :** Le travail [49] est encore en cours. Sa forme n’est donc pas définitive. Nous avons tout de même décidé de l’intégrer dans ce manuscrit comme preuve que les différentes théories présentées dans cette introduction (limite d’échelle, limite locale, graphe stationnaire) peuvent être mêlées dans l’étude d’un seul et même objet : l’UIPQ.

Motivés par les conjectures de Krikun [90], nous avons étendu la bijection CVS pointée présentée en Section 1.2.1 au cas de l’UIPQ. Par rapport au travail effectué par Chassaing et Durhuus [42], nous avons choisi de travailler avec des étiquettes non conditionnées à rester positives. Décrivons la construction.



On note  $T_\infty$  l’arbre de Galton-Watson critique de loi de reproduction géométrique, conditionné à survivre. Cet objet a pour la première fois été introduit par Harry Kesten dans [85]. Brièvement,  $T_\infty$  est un arbre infini plan, obtenu à partir d’une colonne vertébrale à laquelle on accroche de part et d’autre des arbres de Galton-Watson indépendants de loi de reproduction géométrique de paramètre  $1/2$ .

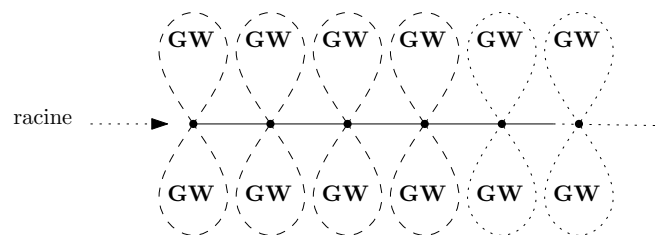

FIGURE 1.10 – Une représentation de l’arbre  $T_\infty$ .

Conditionnellement à  $T_\infty$  on considère un étiquetage aléatoire

$$\ell : T_\infty \longrightarrow \mathbb{Z},$$

obtenu en spécifiant l'étiquette de la racine  $\ell(\emptyset) = 0$ , et tel que les différences d'étiquettes au travers chaque arête de  $T_\infty$  sont indépendantes et de loi uniforme sur  $\{-1, 0, +1\}$ . On étend ensuite la construction de la Section 1.2.1 à l'arbre étiqueté  $(T_\infty, \ell)$  de manière évidente : chaque coin d'étiquette  $i$  est relié au premier coin d'étiquette  $i - 1$  rencontré dans la suite du contour de  $T_\infty$  dans le sens des aiguilles d'une montre. La carte planaire aléatoire  $Q_\infty$  obtenue par cette procédure est une quadrangulation. Elle est enracinée en l'arête émanant du coin racine de l'arbre  $T_\infty$ , son orientation étant donnée par une variable aléatoire de Bernoulli indépendante de  $(T_\infty, \ell)$ .

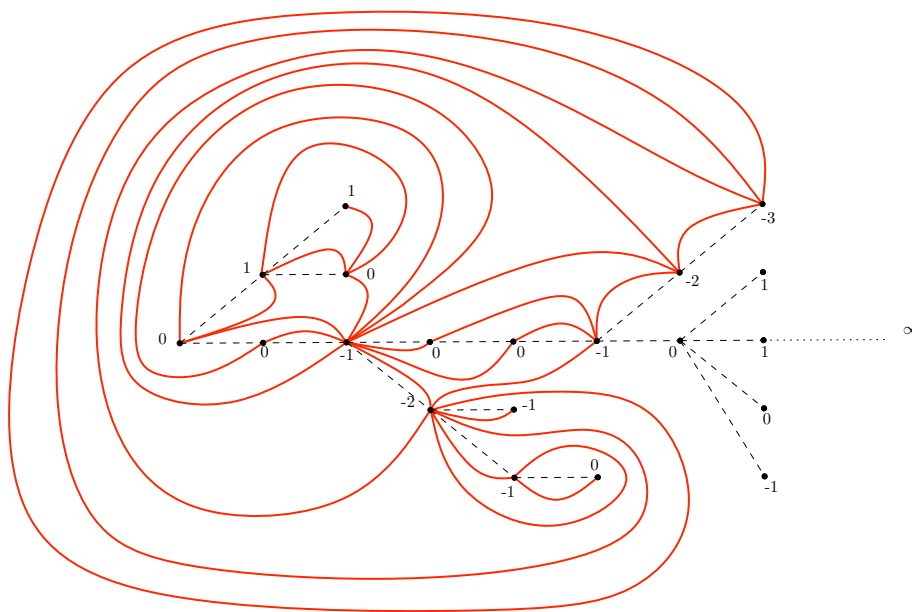

FIGURE 1.11 – Extension de la construction de CVS : on relie (arêtes pleines) chaque coin à son successeur dans le contour de l'arbre infini (en pointillé).

**Théorème 12** ([49]).

La quadrangulation  $Q_\infty$  construite ci-dessus a la même loi que l'UIPQ. De plus les étiquettes  $(\ell(u))_{u \in T_\infty}$  peuvent p.s. être retrouvées, à constante additive près, à partir de la quadrangulation par la formule<sup>16</sup>

$$\ell(u) - \ell(v) = \lim_{z \rightarrow \infty} \left( d_{\text{gr}}^{Q_\infty}(z, u) - d_{\text{gr}}^{Q_\infty}(z, v) \right), \tag{1.9}$$

où  $z \rightarrow \infty$  signifie que la distance entre  $z$  et la racine de  $Q_\infty$  tend vers  $+\infty$ .

**Remarque :** Ce théorème donne donc une troisième construction de la quadrangulation infinie uniforme après la construction originale de Krikun [89] et celle de Chassaing & Durhuus [42, 111].

16. en identifiant les sommets de la quadrangulation avec ceux de  $T_\infty$ .

### Géodésiques dans l’UIPQ

Le fait que le membre de droite de (1.9) admette presque sûrement une limite a été démontré par Krikun [90]. Notre preuve est disjointe et repose sur un phénomène de coalescence des géodésiques, réminiscent du travail de Le Gall sur les géodésiques dans la carte brownienne [99].

**Théorème 13** ([49]). 

---

*Presque sûrement, pour tout sommet  $u \in Q_\infty$ , il existe une suite de sommets  $(P_1^u, P_2^u, \dots)$  telle que toute géodésique infinie partant de  $u$  passe par  $P_1^u, P_2^u, \dots$*  

---

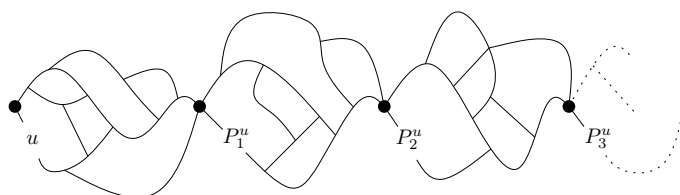

FIGURE 1.12 – L’ensemble des géodésiques émanant d’un point dans l’UIPQ ressemble à un chapelet de saucisses.

### Symétrie

La formule (1.9) montre que l’étiquetage  $\ell$ , *a priori* hérité de la construction à partir de  $(T_\infty, \ell)$ , peut être retrouvé, modulo une constante additive, à partir de la seule quadrangulation  $Q_\infty$  sans la donnée de son arête racine. Cet étiquetage de  $Q_\infty$ , vu à constante additive près, est suffisant pour reconstruire l’arbre  $T_\infty$  : c’est une simple extension de la construction inverse de Schaeffer, voir par exemple [43]. Ainsi, l’arbre  $T_\infty$  est une fonction mesurable de  $Q_\infty$  qui ne dépend pas de l’arête racine de  $Q_\infty$ . Voici un corollaire issu de ces remarques et de la stationnarité de l’UIPQ :

**Corollaire 14** ([49]). 

---

*Soit  $(X_n)_{n \geq 0}$  la suite de sommets visités par la marche aléatoire simple sur  $Q_\infty$  démarrée en l’extrémité de l’arête racine. Alors le processus  $(\ell(X_n))_{n \geq 0}$  est p.s. récurrent.* 

---

### Relation avec la carte brownienne

L’utilisation d’étiquettes non-conditionnées permet de faire des calculs très facilement sur l’arbre  $(T_\infty, \ell)$ . Si  $\tau$  est un arbre planaire et  $h \in \{0, 1, \dots\}$ , notons  $[\tau]_h$  le sous arbre de  $\tau$  formé par les  $h$  premières générations. Si  $T_n$  est un arbre plan uniforme à  $n$  arêtes et  $h_n$  est une suite d’entiers telle que  $h_n = o(\sqrt{n})$ , il est possible, à l’aide de calculs explicites élémentaires, de montrer que la distance en variation totale entre  $[T_\infty]_{h_n}$  et  $[T_n]_{h_n}$  tend vers 0 quand  $n \rightarrow \infty$ . Voici un corollaire en termes de quadrangulations. Rappelons que  $\text{Ball}(q, r)$  représente la boule de rayon  $r$  autour de la racine dans une quadrangulation enracinée  $q$ , et  $Q_n$  est une quadrangulation enracinée uniforme à  $n$  faces.



**Corollaire 15** ([49]).  
*Soit  $(r_n)_{n \geq 0}$  une suite d'entiers telle que  $r_n = o(n^{1/4})$ . Alors la distance en variation totale entre  $\text{Ball}(Q_\infty, r_n)$  et  $\text{Ball}(Q_n, r_n)$  tend vers 0 quand  $n \rightarrow \infty$ .*

Ce « principe de comparaison » entre les grandes quadrangulations uniformes et l'UIPQ permet de transformer des informations acquises sur les limites d'échelle de quadrangulations uniformes en propriétés asymptotiques sur l'UIPQ. Par exemple, le théorème d'homéomorphisme de Le Gall & Paulin [102] nous a permis de résoudre une conjecture de Krikun [89] sur les cycles séparants dans l'UIPQ, voir Chapitre 6 et [49].

Racine de 17 moins 3 sur 2.

---

## 2.1 Théorie des fragmentations

### 2.1.1 Présentation

La théorie des fragmentations, comme son nom l’indique, est une modélisation mathématique du comportement d’une particule qui se morcelle. Nous l’utiliserons ici pour comprendre certains modèles combinatoires où une fragmentation (plus ou moins évidente) intervient. Nous nous contenterons en particulier de la théorie des « fragmentations de masses, binaires, et de mesure de dislocation finie ». Nous conseillons la lecture de l’excellent ouvrage [24] à tous ceux qui veulent en savoir plus.

On note  $\mathcal{S}^\downarrow$  l’ensemble des suites décroissantes de réels positifs dont la somme est plus petite que 1,

$$\mathcal{S}^\downarrow = \left\{ \mathbf{s} = (s_i)_{i \geq 1} : s_1 \geq s_2 \geq \dots \geq 0 : \sum s_i \leq 1 \right\}.$$

Dans toute la suite,  $\nu$  est une mesure de probabilité sur  $\mathcal{S}^\downarrow$  et  $\alpha \in \mathbb{R}_+$ . On construit un processus markovien  $F$  à valeurs dans  $\mathcal{S}^\downarrow$  de la manière suivante. On démarre avec une particule de masse 1 que l’on représente comme  $(1, 0, 0, \dots)$ . Après un temps exponentiel de paramètre  $1^\alpha = 1$ , on scinde la particule initiale en un nuage de particules de masse  $s_1, s_2, \dots$  avec probabilité  $\nu(ds)$ . Chaque particule vit alors indépendamment des autres et subit le même sort que la particule initiale à un changement de temps près : une particule de masse  $m$  vit un temps exponentiel de paramètre  $m^\alpha$  avant de se fragmenter en particules de masses  $m \cdot s_1, m \cdot s_2, \dots$  avec probabilité  $\nu(ds)$ . Le processus de fragmentation  $F(t)$  au temps  $t$  est le ré-arrangement décroissant des masses des particules présentes au temps  $t$ . Il est appelé processus de fragmentation autosimilaire de paramètre  $\alpha$  et de mesure de dislocation  $\nu$ .

Si la mesure de dislocation vérifie  $\nu(\{\mathbf{s} : \sum s_i = 1\}) = 1$ , alors la masse totale des particules est conservée, dans ce cas  $\nu$  est dit conservative. Elle est dissipative dans le cas contraire.

### 2.1.2 Martingale Malthusienne



Dans le cas conservatif, la masse totale des particules est conservée. Il est également possible, dans le cas dissipatif, d’avoir une quantité *stochastiquement* conservée : c’est la somme des masses des particules à une certaine puissance  $\beta^*$  appelé *exposant malthusien*<sup>1</sup> de la fragmentation.

Dans la suite nous nous intéresserons uniquement au cas où

- $\alpha \geq 0$ , les particules les plus grosses se fragmentent le plus vite,
- $\nu(\{\mathbf{s} : 0 < s_1 < 1\}) = 1$ , il n’y a pas de fragmentation triviale,
- $\nu(\{\mathbf{s} : s_2 > 0\}) > 0$ , il y a création d’au moins deux particules avec probabilité positive ...
- $\nu(\{\mathbf{s} : s_3 = 0\}) = 1$ , ... mais au plus deux,
- il existe un  $a > 0$  tel que  $\int d\nu(\mathbf{s}) s_2^{-a} < \infty$ .

Avec ces hypothèses sur  $\nu$ , il est facile de voir qu’il existe un unique  $\beta^* \in (0, 1]$  appelé *exposant malthusien* de  $\nu$  tel que

$$\int_{\mathcal{S}^\downarrow} d\nu(\mathbf{s}) (s_1^{\beta^*} + s_2^{\beta^*}) = 1,$$

où l’on pose par convention  $0^0 = 0$ . Il est aisé de vérifier que si l’on note  $F(t) = (s_1(t), s_2(t), \dots)$ , alors le processus

$$M_t = \sum_{i=1}^{\infty} s_i(t)^{\beta^*} \tag{2.1}$$

est une martingale positive, qui converge presque sûrement vers sa valeur terminale notée  $M_\infty$ . Cette quantité est d’un grand intérêt comme le montre le théorème suivant.

**Théorème** ([25]). *Notons  $F(t) = (s_1(t), s_2(t), \dots)$ , on a pour tout  $\beta \geq 0$*

$$t^{\frac{\beta-\beta^*}{\alpha}} \sum_{i=1}^{\infty} s_i(t)^\beta \xrightarrow[t \rightarrow \infty]{\mathbb{L}^2} K_\nu(\alpha, \beta) \cdot M_\infty, \tag{2.2}$$

où  $K_\nu(\alpha, \beta)$  est une constante dépendant de  $\alpha, \beta$  et  $\nu$ , et  $M_\infty$  est la valeur terminale de la martingale introduite précédemment.



J. Bertoin (gauche)  
A. Gnedin (droite)

En particulier, si l’on applique le théorème précédent avec  $\beta = 0$ , on voit que le nombre de particules dans la fragmentation  $F$  à l’instant  $t$  est approximativement  $t^{\beta^*/\alpha}$ , et qu’une fois renormalisé par ce facteur, il converge au sens  $\mathbb{L}^2$  vers un multiple de  $M_\infty$ . C’est ce corollaire que nous avons utilisé dans les deux modèles décrits dans les sections suivantes.

1. Malthus a dit : “The power of population is indefinitely greater than the power in the earth to produce subsistence for man”.

## 2.2 Triangulations récursives (Chap. 7 ou [47])

Les résultats présentés dans cette section et détaillés dans le Chapitre 7 sont tirés de [47] et ont été obtenus en collaboration avec **Jean-François Le Gall**.

Dans cette partie,  $\beta^* = \frac{\sqrt{17} - 3}{2}$ .

Poursuivant l’approche d’Aldous [5, 6], nous avons étudié des triangulations infinies du disque  $\mathbb{D}$  qui apparaissent comme limite de différents modèles de triangulations du  $n$ -gone discret. Au lieu d’étudier des triangulations uniformes [5, 6] qui sont à la limite très intimement au CRT, nous nous sommes concentré sur des modèles de triangulations dites *récursives* qui exhibent un tout autre comportement. Décrivons un de ces modèles pour présenter nos résultats.

On considère une suite  $U_1, V_1, U_2, V_2, \dots$  de variables aléatoires indépendantes et identiquement distribuées sur le cercle  $\mathbb{S}_1$ . On construit ensuite par récurrence une suite de fermés  $L_1, L_2, \dots$  du disque fermé  $\overline{\mathbb{D}}$ . On définit pour commencer  $L_1 = [U_1 V_1]$  la corde (euclidienne) d’extrémités  $U_1$  et  $V_1$ . Pour  $n \geq 2$  on distingue deux cas. Soit la corde  $[U_n V_n]$  n’intersecte pas  $L_{n-1}$  et dans ce cas on pose  $L_n = L_{n-1} \cup [U_n V_n]$ , sinon on pose  $L_n = L_{n-1}$ . On vérifie aisément que  $L_n$  est une union disjointe de cordes.

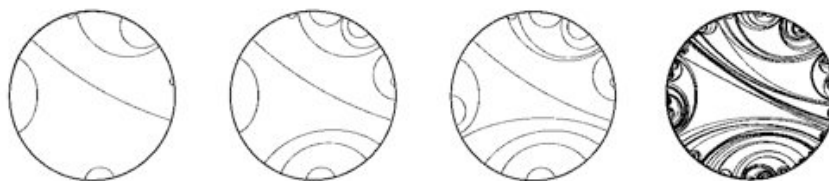

FIGURE 2.1 – Une illustration du processus  $(L_n)_{n \geq 1}$ . On a dessiné les cordes en géométrie hyperbolique pour des raisons esthétiques.

On définit alors

$$L_\infty = \overline{\bigcup_{n=1}^{\infty} L_n}.$$

**Théorème 16** ([47]).

L’ensemble fermé aléatoire  $L_\infty$  est presque sûrement une triangulation du disque  $\overline{\mathbb{D}}$  de dimension de Hausdorff

$$\dim(L_\infty) = 1 + \frac{\sqrt{17} - 3}{2}.$$

Par *triangulation* du disque nous entendons que les composantes connexes de  $\overline{\mathbb{D}} \setminus L_\infty$  sont toutes des triangles euclidiens.

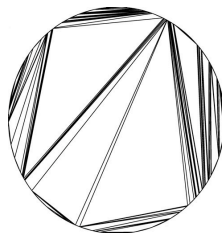

FIGURE 2.2 – Le fermé aléatoire  $L_\infty$  avec cordes euclidiennes.

Le théorème précédent a principalement deux parties essentiellement disjointes. La première consiste à établir que la dimension de Hausdorff de  $L_\infty$  est p.s.  $1 + \beta^*$ . Cela passe par l'étude d'un processus annexe et requiert la théorie des fragmentations. La deuxième partie, c'est-à-dire le fait que  $L_\infty$  soit une triangulation du disque, nécessite l'introduction et l'étude d'un analogue d'une marche branchante sur l'arbre binaire complet.

### 2.2.1 Processus de hauteur

Notons  $N(L_n)$  le nombre de cordes dans  $L_n$ . Pour  $x, y \in \mathbb{S}_1$ , on définit la hauteur entre  $x$  et  $y$  dans  $L_n$ , notée  $H_n(x, y)$ , comme le nombre de cordes de  $L_n$  qu'intersecte la corde  $[xy]$ .

**Théorème 17** ([47]).

(i) On a

$$n^{-1/2}N(L_n) \xrightarrow[n \rightarrow \infty]{p.s.} \sqrt{\pi}.$$

(ii) Il existe un processus aléatoire  $(\mathcal{M}_\infty(x), x \in \mathbb{S}_1)$  Hölder d'exposant  $\beta^* - \varepsilon$  pour tout  $\varepsilon > 0$ , tel que pour tout  $x \in \mathbb{S}_1$ ,

$$n^{-\beta^*/2}H_n(1, x) \xrightarrow[n \rightarrow \infty]{(\mathbb{P})} \mathcal{M}_\infty(x),$$

où  $\xrightarrow{(\mathbb{P})}$  signifie convergence en probabilité.

Quelques mots sur la preuve. Ce résultat utilise très fortement la convergence (2.2). Il est en effet assez facile de relier le processus  $N(L_n)$  à un processus de fragmentation conservatif : il suffit de considérer le cercle  $\mathbb{S}_1$  comme une particule de masse 1 qui est fragmentée par les cordes de  $L_n$ . Les particules créées par  $L_n$  sont représentées par les composantes connexes de  $\overline{\mathbb{D}} \setminus L_n$  et leurs masses sont données par la mesure de Lebesgue normalisée de leurs frontières en commun avec  $\mathbb{S}_1$ . Pour qu'une particule se fragmente, disons à la  $n$ -ième étape, il faut que les deux points  $U_n$  et  $V_n$  appartiennent à sa frontière, ce qui arrive avec probabilité la masse de la particule au carré. Une version en temps continu du processus précédent donne exactement un processus de fragmentation conservatif de paramètre d'autosimilarité 2, d'où l'exposant 1/2 dans la

première convergence<sup>2</sup>.

En ce qui concerne la deuxième convergence, on montre tout d’abord qu’une version en temps continu de  $H_n(1, U)$ , où  $U$  est uniforme sur  $[0, 1]$  et indépendant de  $(L_n)_{n \geq 0}$ , compte exactement le nombre particules dans un certain processus de fragmentation. Ce processus est formé par les composantes connexes de  $\overline{\mathbb{D}} \setminus L_n$  qui intersectent le segment  $[1U]$ . Les masses de ses particules sont également données par la mesure de Lebesgue normalisée de leurs frontières avec  $\mathbb{S}_1$ . Ce processus de fragmentation est dissipatif car toutes les composantes connexes de  $\overline{\mathbb{D}} \setminus L_n$  n’intersectent par forcément  $[1U]$ . Sa mesure de dislocation  $\nu_D$  est donnée par

$$\int_{[0,1]^2} \nu_D(ds_1, ds_2) F(s_1, s_2) = 2 \int_0^1 du u^2 F(u, 0) + 4 \int_{1/2}^1 du u(1-u) F(u, 1-u).$$

pour tout fonction borélienne  $F$ . On calcul aisément son exposant malthusien  $\beta^* = \frac{\sqrt{17}-3}{2}$ , et son paramètre d’autosimilarité est 2 comme dans le cas précédent. On applique alors (2.2) pour obtenir la convergence en probabilité de  $n^{-\beta^*/2} H_n(1, U)$  quand  $n \rightarrow \infty$ . La version à  $x$  fixé à la place de  $U$  découle d’un argument d’absolue continuité assez délicat. Enfin, le caractère Höldérien du processus  $\mathcal{M}_\infty$  provient d’estimées fines sur les moments  $\mathbb{E}[\mathcal{M}_\infty(x)^p]$  obtenues à l’aide d’équations intégrales vérifiées par les moments de  $\mathcal{M}_\infty(\cdot)$ . Le calcul de la dimension de Hausdorff de  $L_\infty$  est très relié au caractère  $\beta^* - \varepsilon$  Hölder de  $\mathcal{M}_\infty$ .

### 2.2.2 Triangulation

Un fragment de  $L_n$  est par définition une composante connexe de  $\overline{\mathbb{D}} \setminus L_n$ . Ces fragments ont une structure généalogique aisément descriptible. Le premier fragment est  $\overline{\mathbb{D}}$  que l’on note  $\emptyset$ . Puis la première corde  $[U_1 V_1]$  découpe  $\overline{\mathbb{D}}$  en deux fragments, qui sont vus comme les descendants de  $\emptyset$ . On les ordonne aléatoirement : avec probabilité 1/2 le premier enfant de  $\emptyset$ , noté 1, est le plus grand fragment, et le second enfant, noté 0, est l’autre fragment. Avec probabilité 1/2 c’est le contraire. On itère cette procédure et tous les fragments apparaissant dans le processus  $(L_n)_{n \geq 1}$  sont étiquetés par un élément de l’arbre binaire complet

$$\mathbb{T}_2 = \bigcup_{n \geq 0} \{0, 1\}^n \quad \text{où } \{0, 1\}^0 = \emptyset.$$

Si  $\mathfrak{F}$  est un fragment, on appelle *bout* de  $\mathfrak{F}$  toute composante connexe de  $\mathfrak{F} \cap \mathbb{S}_1$ . Pour des raisons qui vont devenir claires,  $\overline{\mathbb{D}}$  est vu comme un fragment avec 0 bout. Ainsi, on peut associer à chaque élément  $u \in \mathbb{T}_2$  un nombre  $\ell_0(u) \in \{0, 1, 2, 3, \dots\}$ , qui correspond au nombre de bouts du fragment associé. On peut vérifier (Lemme 5.5 de [47]) que l’étiquetage ainsi obtenu sur  $\mathbb{T}_2$  peut être décrit par le mécanisme de branchement suivant. Pour tout  $u \in \mathbb{T}_2$  d’étiquette  $m \geq 0$ , on choisit uniformément  $m_1 \in \{0, 1, \dots, m\}$  et l’on étiquette ses deux enfants avec les valeurs  $1+m_1$  et  $1+m-m_1$ .

---

2. la convergence presque sûre est alors obtenue en utilisant les résultats de Brennan et Durrett sur les processus de fragmentations conservatifs [36, 37]

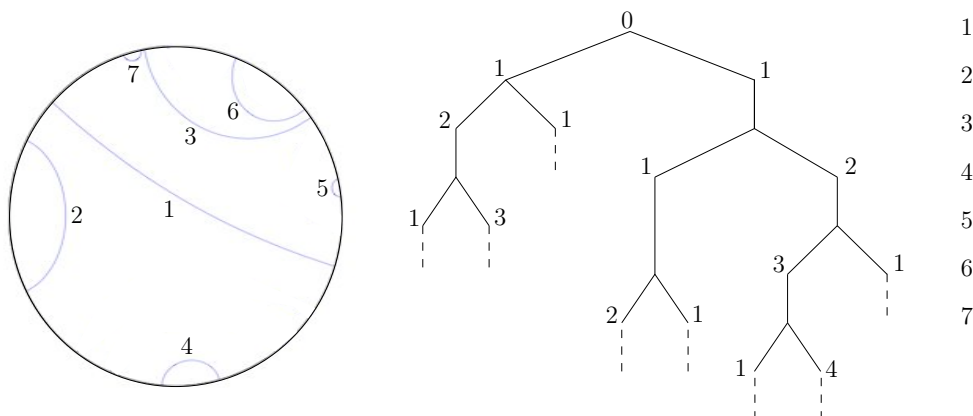

FIGURE 2.3 – Les 7 premières cordes du processus  $(L_n)_{n \geq 1}$  et l’étiquetage de l’arbre binaire complet associé.

L’étiquetage de  $\mathbb{T}_2$  que l’on obtient avec le mécanisme de branchement décrit ci-dessus, mais en commençant avec une valeur  $a \geq 0$  à l’origine  $\emptyset$ , est noté  $(\ell_a(u))_{u \in \mathbb{T}_2}$ . Pour  $u = (u_1, u_2, \dots) \in \mathbb{T}_2 \cup \{0, 1\}^{\mathbb{N}}$ , on note  $[u]_k = (u_1, u_2, \dots, u_k)$  pour tout  $k \geq 0$ . Le fait que  $L_\infty$  est une triangulation du disque est intimement lié à la proposition suivante :

**Proposition 18** ([47]).

*Presque sûrement, il n’existe pas de lignée infinie dans  $\mathbb{T}_2$  telle que toutes les étiquettes pour  $\ell_4$  soit plus grande que 4,*

$$\mathbb{P}(\exists u \in \{0, 1\}^{\mathbb{N}} : \ell_4([u]_k) \geq 4, \forall k \geq 0) = 0.$$

Nous avons même récemment, et en collaboration avec **Yuval Peres**, obtenu une version quantitative de la proposition précédente réminiscente des célèbres estimées de Kolmogorov sur les processus de Galton-Watson critiques de variance finie. Ces résultats sont détaillés dans le Chapitre 8.

**Théorème 19** ([50]).

*Soit  $G_n = \{u \in \{0, 1\}^n : \ell_4([u]_k) \geq 4, \forall k \in \{0, 1, \dots, n\}\}$  l’ensemble des chemins dans  $\mathbb{T}_2$  liant l’origine à la  $n$ ème génération le long desquels les étiquettes pour  $\ell_4$  restent plus grandes que 4. Alors on a*

$$\mathbb{E} [\#G_n] \xrightarrow{n \rightarrow \infty} \frac{4}{e^2 - 1}. \tag{2.3}$$

*De plus, il existe des constantes  $0 < c_1 < c_2 < \infty$  telles que pour  $n \geq 1$*

$$\frac{c_1}{n} \leq \mathbb{P}(G_n \neq \emptyset) \leq \frac{c_2}{n}. \tag{2.4}$$

Le fait que  $L_\infty$  est une triangulation n’est pas anecdotique et est primordial pour montrer la convergence d’autres modèles discrets vers l’objet  $L_\infty$ , voir [47]

### 2.3 Quadrees (Chap. 9 ou [46])

*Les résultats présentés dans cette section et détaillés dans le Chapitre 9 sont tirés de [46] et ont été obtenus en collaboration avec **Adrien Joseph**.*

$$\text{Ici aussi, } \beta^* = \frac{\sqrt{17} - 3}{2}.$$

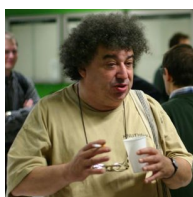

Le modèle du *quadtree* a été introduit en informatique par Finkel et Bentley [66] comme un algorithme de stockage et de recherche de données. L’étude de ce modèle (en particulier la présence du même exposant  $\frac{\sqrt{17}-3}{2}$ ) nous a été suggérée par Philippe Flajolet à la conférence ALEA 2009. Merci encore !

Décrivons le modèle en dimension 2. Soit  $P_1, P_2, \dots$  une suite de variables indépendantes uniformément distribuées sur le carré  $[0, 1]^2$ . Les points tombent les uns après les autres, et, à chaque fois qu’un point tombe, il divise le rectangle qui le contient en quatre sous-rectangles par rapport à l’abscisse et l’ordonnée de ce point. On note  $\text{Quad}(P_1, \dots, P_n)$  l’ensemble des  $3n + 1$  rectangles formés par les  $n$  premiers points. Voir Fig.2.4.

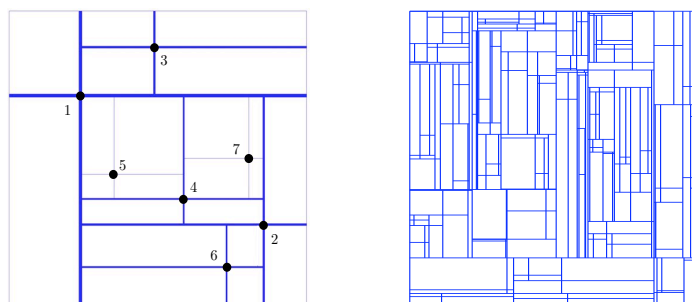

FIGURE 2.4 – Deux quadtrees. L’un avec 7 points l’autre avec 100.

En particulier nous nous sommes intéressés au « Partial Match Query » : Fixons  $x \in [0, 1]$ , et notons  $\mathcal{N}_n(x)$  le nombre de rectangles de  $\text{Quad}(P_1, \dots, P_n)$  qui intersectent la ligne verticale  $[(x, 0), (x, 1)]$ . Notre principal résultat est le suivant.

**Théorème 20** ([46]).

*Pour tout  $x \in [0, 1]$ , on a la convergence suivante*

$$n^{-\beta^*} \mathbb{E}[\mathcal{N}_n(x)] \xrightarrow{n \rightarrow \infty} K_0(x(1-x))^{\beta^*/2},$$

$$\text{où } \beta^* = \frac{\sqrt{17} - 3}{2}, \quad \text{et } K_0 = \frac{\Gamma(2\beta^* + 2)\Gamma(\beta^* + 2)}{2\Gamma^3(\beta^* + 1)\Gamma^2\left(\frac{\beta^*}{2} + 1\right)}.$$



La convergence du théorème précédent est d’abord établie lorsque  $x$  est remplacé par une variable aléatoire  $U$  uniforme sur  $[0, 1]$  et indépendante des  $(P_i)_{i \geq 1}$ . Ce cas avait été traité précédemment [67] par des méthodes analytiques. Nous avons proposé une nouvelle approche avec la théorie des fragmentations, en remarquant que l’espérance de  $\mathcal{N}_n(U)$  (dans une version en temps continu) est égale à l’espérance du nombre de particules dans un processus de fragmentation de paramètre d’autosimilarité 1 et de mesure de dislocation  $\nu_Q$  donnée par

$$\int_{\mathcal{S}^1} \nu_Q(ds_1, ds_2) F(s_1, s_2) = 4 \int_0^1 dx \int_{1/2}^1 dy x F(xy, x(1-y)),$$

pour toute fonction borélienne  $F$ . En particulier l’exposant malthusien de cette fragmentation est  $\beta^*$ . La preuve du Théorème 20 repose sur la convergence sus-dite, un argument de couplage et une méthode de point fixe pour des équations intégrales. Des progrès sont en cours (communication personnelle de Nicolas Broutin, Ralph Neininger et Henning Sulzbach) pour la convergence en loi de  $(\mathcal{N}_n(x))_{x \in [0,1]}$  en tant que processus.

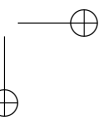
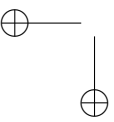
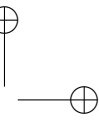
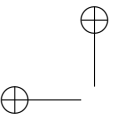

PARTIE

2

---

Cartes Planaires Aléatoires

---

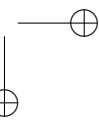
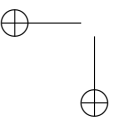
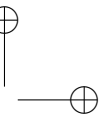
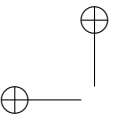

# The Brownian Cactus

---

LES RÉSULTATS DE CE CHAPITRE ONT ÉTÉ OBTENUS EN COLLABORATION AVEC JEAN-FRANÇOIS LE GALL ET GRÉGORY MIERMONT ONT ÉTÉ SOUMIS POUR PUBLICATION.

The cactus of a pointed graph is a discrete tree associated with this graph. Similarly, with every pointed geodesic metric space  $E$ , one can associate an  $\mathbb{R}$ -tree called the continuous cactus of  $E$ . We prove under general assumptions that the cactus of random planar maps distributed according to Boltzmann weights and conditioned to have a fixed large number of vertices converges in distribution to a limiting space called the Brownian cactus, in the Gromov-Hausdorff sense. Moreover, the Brownian cactus can be interpreted as the continuous cactus of the so-called Brownian map.

## 3.1 Introduction

In this work, we associate with every pointed graph a discrete tree called the cactus of the graph. Assuming that the pointed graph is chosen at random in a certain class of planar maps with a given number of vertices, and letting this number tend to infinity, we show that, modulo a suitable rescaling, the associated cactus converges to a universal object, which we call the Brownian cactus.

In order to motivate our results, let us recall some basic facts about planar maps. A planar map is a proper embedding of a finite connected graph in the two-dimensional sphere, viewed up to orientation-preserving homeomorphisms of the sphere. The faces of the map are the connected components of the complement of edges, and the degree of a face counts the number of edges that are incident to it, with the convention that if both sides of an edge are incident to the same face, this edge is counted twice in the degree of the face. Special cases of planar maps are triangulations, where each face has degree 3, quadrangulations, where each face has degree 4 and more generally  $p$ -angulations where each face has degree  $p$ . Since the pioneering work of Tutte [142], planar maps have been thoroughly studied in combinatorics, and they also arise in other areas of mathematics : See in particular the book of Lando and Zvonkin [93] for algebraic and geometric motivations. Large random planar graphs are of interest in theoretical physics, where they serve as models of random geometry [9].

A lot of recent work has been devoted to the study of scaling limits of large random planar maps viewed as compact metric spaces. The vertex set of the planar map is

equipped with the graph distance, and one is interested in the convergence of the (suitably rescaled) resulting metric space when the number of vertices tends to infinity, in the sense of the Gromov-Hausdorff distance. In the particular case of triangulations, this problem was stated by Schramm [129]. It is conjectured that, under mild conditions on the underlying distribution of the random planar map, this convergence holds and the limit is the so-called Brownian map. Despite some recent progress [110, 109, 98, 33, 99], this conjecture is still open, even in the simple case of uniformly distributed quadrangulations. The main obstacle is the absence of a characterization of the Brownian map as a random metric space. A compactness argument can be used to get the existence of sequential limits of rescaled random planar maps [98], but the fact that there is no available characterization of the limiting object prevents one from getting the desired convergence.

In the present work, we treat a similar problem, but we replace the metric space associated with a planar map by a simpler metric space called the cactus of the map. Thanks to this replacement, we are able to prove, in a very general setting, the existence of a scaling limit, which we call the Brownian cactus. Although this result remains far from the above-mentioned conjecture, it gives another strong indication of the universality of scaling limits of random planar maps, in the spirit of the papers [43, 109, 114, 119] which were concerned with the profile of distances from a particular point.

Let us briefly explain the definition of the discrete cactus (see subsection 3.2.1 for more details). We start from a graph  $\mathbf{G}$  with a distinguished vertex  $\rho$ . Then, if  $a$  and  $b$  are two vertices of  $\mathbf{G}$ , and if  $a_0 = a, a_1, \dots, a_p = b$  is a path from  $a$  to  $b$  in the graph  $\mathbf{G}$ , we consider the quantity

$$d_{\text{gr}}(\rho, a) + d_{\text{gr}}(\rho, b) - 2 \min_{0 \leq i \leq p} d_{\text{gr}}(\rho, a_i)$$

where  $d_{\text{gr}}$  stands for the graph distance in  $\mathbf{G}$ . The cactus distance  $d_{\text{Cac}}^{\mathbf{G}}(a, b)$  is then the minimum of the preceding quantities over all choices of a path from  $a$  to  $b$ . The cactus distance is in fact only a pseudo-distance : We have  $d_{\text{Cac}}^{\mathbf{G}}(a, b) = 0$  if and only if  $d_{\text{gr}}(\rho, a) = d_{\text{gr}}(\rho, b)$  and if there is a path from  $a$  to  $b$  that stays at distance at least  $d_{\text{gr}}(\rho, a)$  from the point  $\rho$ . The cactus  $\text{Cac}(\mathbf{G})$  associated with  $\mathbf{G}$  is the quotient space of the vertex set of  $\mathbf{G}$  for the equivalence relation  $\asymp$  defined by putting  $a \asymp b$  if and only if  $d_{\text{Cac}}^{\mathbf{G}}(a, b) = 0$ . The set  $\text{Cac}(\mathbf{G})$  is equipped by the distance induced by  $d_{\text{Cac}}^{\mathbf{G}}$ . It is easy to verify that  $\text{Cac}(\mathbf{G})$  is a discrete tree (Proposition 3.2). Although much information is lost when going from  $\mathbf{G}$  to its cactus,  $\text{Cac}(\mathbf{G})$  still has a rich structure, as we will see in the case of planar maps.

A continuous analogue of the cactus can be defined for a (compact) geodesic metric space  $\mathbf{E}$  having a distinguished point  $\rho$ . As in the discrete setting, the cactus distance between two points  $x$  and  $y$  is the infimum over all continuous paths  $\gamma$  from  $x$  to  $y$  of the difference between the sum of the distances of  $x$  and  $y$  to the distinguished point  $\rho$  and twice the minimal distance of a point of  $\gamma$  to  $\rho$ . Again this is only a pseudo-distance, and the continuous cactus  $\text{Kac}(\mathbf{E})$  is defined as the corresponding quotient space of  $\mathbf{E}$ . One can then check that the mapping  $\mathbf{E} \rightarrow \text{Kac}(\mathbf{E})$  is continuous, and even Lipschitz, with respect to the Gromov-Hausdorff distance between pointed metric spaces (Proposition 3.7). It follows that if a sequence of (rescaled) pointed graphs  $\mathbf{G}_n$

converges towards a pointed space  $\mathbf{E}$  in the Gromov-Hausdorff sense, the (rescaled) cactuses  $\text{Cac}(\mathbf{G}_n)$  also converge to  $\text{Kac}(\mathbf{E})$ . In particular, this implies that  $\text{Kac}(\mathbf{E})$  is an  $\mathbb{R}$ -tree (we refer to [63] for the definition and basic properties of  $\mathbb{R}$ -trees).

The preceding observations yield a first approach to the convergence of rescaled cactuses associated with random planar maps. Let  $p \geq 2$  be an integer, and for every  $n \geq 2$ , let  $m_n$  be a random planar map that is uniformly distributed over the set of all rooted  $2p$ -angulations with  $n$  faces (recall that a planar map is rooted if there is a distinguished edge, which is oriented and whose origin is called the root vertex). We view the vertex set  $V(m_n)$  of  $m_n$  as a metric space for the graph distance  $d_{\text{gr}}$ , with a distinguished point which is the root vertex of the map. According to [98], from any given strictly increasing sequence of integers, we can extract a subsequence along which the rescaled pointed metric spaces  $(V(m_n), n^{-1/4} d_{\text{gr}})$  converge in distribution in the Gromov-Hausdorff sense. As already explained above, the limiting distribution is not uniquely determined, and may depend on the chosen subsequence. Still we call Brownian map any possible limit that may arise in this convergence. Although the distribution of the Brownian map has not been characterized, it turns out that the distribution of its continuous cactus is uniquely determined. Thanks to this observation, one easily gets that the suitably rescaled discrete cactus of  $m_n$  converges in distribution to a random metric space (in fact a random  $\mathbb{R}$ -tree) which we call the Brownian cactus : See Corollary 3.15 below.

Let us give a brief description of the Brownian cactus. The random  $\mathbb{R}$ -tree known as the CRT, which has been introduced and studied by Aldous [2, 4] is denoted by  $(\mathcal{T}_{\mathbf{e}}, d_{\mathbf{e}})$ . The notation  $\mathcal{T}_{\mathbf{e}}$  refers to the fact that the CRT is conveniently viewed as the  $\mathbb{R}$ -tree coded by a normalized Brownian excursion  $\mathbf{e} = (e_t)_{0 \leq t \leq 1}$  (see Section 3.3 for more details). Let  $(Z_a)_{a \in \mathcal{T}_{\mathbf{e}}}$  be Brownian labels on the CRT. Informally, we may say that, conditionally on  $\mathcal{T}_{\mathbf{e}}$ ,  $(Z_a)_{a \in \mathcal{T}_{\mathbf{e}}}$  is a centered Gaussian process which vanishes at the root of the CRT and satisfies  $\mathbb{E}[(Z_a - Z_b)^2] = d_{\mathbf{e}}(a, b)$  for every  $a, b \in \mathcal{T}_{\mathbf{e}}$ . Let  $a_*$  be the (almost surely unique) vertex of  $\mathcal{T}_{\mathbf{e}}$  with minimal label. For every  $a, b \in \mathcal{T}_{\mathbf{e}}$ , let  $[[a, b]]$  stand for the geodesic segment between  $a$  and  $b$  in the tree  $\mathcal{T}_{\mathbf{e}}$ , and set

$$d_{\text{KAC}}(a, b) = Z_a + Z_b - 2 \min_{c \in [[a, b]]} Z_c.$$

Then  $d_{\text{KAC}}$  is a pseudo-distance on  $\mathcal{T}_{\mathbf{e}}$ . The Brownian cactus KAC is the quotient space of the CRT for this pseudo-distance. As explained above, it can also be viewed as the continuous cactus associated with the Brownian map (here and later, we abusively speak about “the” Brownian map although its distribution may not be unique).

The main result of the present work (Theorem 3.20) states that the Brownian cactus is also the limit in distribution of the discrete cactuses associated with very general random planar maps. To explain this more precisely, we need to discuss Boltzmann distributions on planar maps. For technical reasons, we consider rooted and pointed planar maps, meaning that in addition to the root edge there is a distinguished vertex. Let  $\mathbf{q} = (q_1, q_2, \dots)$  be a sequence of non-negative weights satisfying general assumptions (we require that  $\mathbf{q}$  has finite support, that  $q_k > 0$  for some  $k \geq 3$ , and that  $\mathbf{q}$  is critical in the sense of [109, 114] – the latter property can always be achieved by multiplying  $\mathbf{q}$  by a suitable positive constant). For every rooted and pointed planar

map  $m$ , set

$$W_{\mathbf{q}}(m) = \prod_{f \in F(m)} q_{\deg(f)}$$

where  $F(m)$  stands for the set of all faces of  $m$  and  $\deg(f)$  is the degree of the face  $f$ . For every  $n$ , choose a random rooted and pointed planar map  $M_n$  with  $n$  vertices, in such a way that  $\mathbb{P}(M_n = m)$  is proportional to  $W_{\mathbf{q}}(m)$  (to be precise, we need to restrict our attention to those integers  $n$  such that there exists at least one planar map  $m$  with  $n$  vertices such that  $W_{\mathbf{q}}(m) > 0$ ). View  $M_n$  as a graph pointed at the distinguished vertex of  $M_n$ . Then Theorem 3.20 gives the existence of a positive constant  $B_{\mathbf{q}}$  such that

$$B_{\mathbf{q}} n^{-1/4} \cdot \text{Cac}(M_n) \xrightarrow[n \rightarrow \infty]{(d)} \text{KAC}$$

in the Gromov-Hausdorff sense. Here the notation  $\lambda \cdot E$  means that distances in the metric space  $E$  are multiplied by the factor  $\lambda$ . This result applies in particular to uniformly distributed  $p$ -angulations with a fixed number of faces (by Euler’s formula the number of vertices is then also fixed), and thus for instance to triangulations. In contrast with the first approach described above, we do not need to restrict ourselves to the bipartite case where  $p$  is even.

As in much of the previous work on asymptotics for large random planar maps, the proof of Theorem 3.20 relies on the existence [32] of “nice” bijections between planar maps and certain multitype labeled trees. It was observed in [109] (for the bipartite case) and in [114] that the tree associated with a random planar map following a Boltzmann distribution is a (multitype) Galton-Watson tree, whose offspring distributions are determined explicitly in terms of the Boltzmann weights, and which is equipped with labels that are uniformly distributed over admissible choices. This labeled tree can be conveniently coded by the two random functions called the contour process and the label process (see the end of subsection 3.4.3). In the bipartite case, where  $q_k = 0$  if  $k$  is odd, one can prove [109] that the contour process and the label process associated with the random planar map  $M_n$  converge as  $n \rightarrow \infty$ , modulo a suitable rescaling, towards the pair consisting of a normalized Brownian excursion and the (tip of the) Brownian snake driven by this excursion. This convergence is a key tool for studying the convergence of rescaled (bipartite) random planar maps towards the Brownian map [98]. In our general non-bipartite setting, it is not known whether the preceding convergence still holds, but Miermont [114] observed that it does hold if the tree is replaced by a “shuffled” version. Fortunately for our purposes, although the convergence of the coding functions of the shuffled tree would not be effective to study the asymptotics of rescaled planar maps, it gives enough information to deal with the associated cactuses. This is one of the key points of the proof of Theorem 3.20 in Section 3.4.

The last two sections of the present work are devoted to some properties of the Brownian cactus. We first show that the Hausdorff dimension of the Brownian cactus is equal to 4 almost surely, and is therefore the same as that of the Brownian map computed in [98]. As a tool for the calculation of the Hausdorff dimension, we derive precise information on the volume of balls centered at a typical point of the Brownian cactus (Proposition 3.24). Finally, we apply ideas of the theory of the Brownian cactus to a problem about the geometry of the Brownian map. Precisely, given three “typical”



points in the Brownian map, we study the existence and uniqueness of a cycle with minimal length that separates the first point from the second one and visits the third one. This is indeed a continuous version of a problem discussed by Bouttier and Guitter [34] in the discrete setting of large quadrangulations. In particular, we recover the explicit distribution of the volume of the connected components bounded by the minimizing cycle, which had been derived in [34] via completely different methods. The results of this section strongly rely on the study of geodesics in the Brownian map developed in [99].

The subsequent paper [94] derives further results about the Brownian cactus and in particular studies the asymptotic behavior of the number of “branches” of the cactus above level  $h$  that hit level  $h + \varepsilon$ , when  $\varepsilon$  goes to 0. In terms of the Brownian map, if  $B(\rho, h)$  denotes the open ball of radius  $h$  centered at the root  $\rho$  and  $N_{h,\varepsilon}$  denotes the number of connected components of the complement of  $B(\rho, h)$  that intersect the complement of  $B(\rho, h + \varepsilon)$ , the main result of [94] states that  $\varepsilon^3 N_{h,\varepsilon}$  converges as  $\varepsilon$  goes to 0 to a nondegenerate random variable. This convergence is closely related to an upcrossing approximation for the local time of super-Brownian motion, which is of independent interest.

The paper is organized as follows. In Section 3.2, we give the definitions and main properties of discrete and continuous cactuses, and establish connections between the discrete and the continuous case. In Section 3.3, after recalling the construction and main properties of the Brownian map, we introduce the Brownian cactus and show that it coincides with the continuous cactus of the Brownian map. Section 3.20 contains the statement and the proof of our main result Theorem 3.20. As a preparation for the proof, we recall in subsection 3.4.1 the construction and main properties of the bijections between planar maps and multitype labeled trees. Section 3.5 is devoted to the Hausdorff dimension of the Brownian cactus, and Section 5.15 deals with minimizing cycles in the Brownian map. An appendix gathers some facts about planar maps with Boltzmann distributions, that are needed in Section 3.4.

**Acknowledgement.** We thank Itai Benjamini for the name cactus as well as for suggesting the study of this mathematical object.

## 3.2 Discrete and continuous cactuses

### 3.2.1 The discrete cactus

Throughout this section, we consider a graph  $G = (V, \mathcal{E})$ , meaning that  $V$  is a finite set called the vertex set and  $\mathcal{E}$  is a subset of the set of all (unordered) pairs  $\{v, v'\}$  of distinct elements of  $V$ .

If  $v, v' \in V$ , a *path* from  $v$  to  $v'$  in  $G$  is a finite sequence  $\gamma = (v_0, \dots, v_n)$  in  $V$ , such that  $v_0 = v$ ,  $v_n = v'$  and  $\{v_{i-1}, v_i\} \in \mathcal{E}$ , for every  $1 \leq i \leq n$ . The integer  $n \geq 0$  is called the length of  $\gamma$ . We assume that  $G$  is connected, so that a path from  $v$  to  $v'$  exists for every choice of  $v$  and  $v'$ . The *graph distance*  $d_{\text{gr}}^G(v, v')$  is the minimal length of a path from  $v$  to  $v'$  in  $G$ . A path with minimal length is called a *geodesic* from  $v$  to  $v'$  in  $G$ .

In order to define the cactus distance we consider also a distinguished point  $\rho$  in  $V$ . The triplet  $\mathbf{G} = (V, \mathcal{E}, \rho)$  is then called a *pointed graph*. With this pointed graph we

associate the cactus (pseudo-)distance defined by setting for every  $v, v' \in V$ ,

$$d_{\text{Cac}}^{\mathbf{G}}(v, v') := d_{\text{gr}}^G(\rho, v) + d_{\text{gr}}^G(\rho, v') - 2 \max_{\gamma: v \rightarrow v'} \min_{a \in \gamma} d_{\text{gr}}^G(\rho, a),$$

where the maximum is over all paths  $\gamma$  from  $v$  to  $v'$  in  $G$ .

**Proposition 3.1.** *The mapping  $(v, v') \rightarrow d_{\text{Cac}}^{\mathbf{G}}(v, v')$  is a pseudo-distance on  $V$  taking integer values. Moreover, for every  $v, v' \in V$ ,*

$$d_{\text{gr}}^G(v, v') \geq d_{\text{Cac}}^{\mathbf{G}}(v, v'). \quad (3.1)$$

and

$$d_{\text{Cac}}^{\mathbf{G}}(\rho, v) = d_{\text{gr}}^G(\rho, v). \quad (3.2)$$

*Démonstration.* It is obvious that  $d_{\text{Cac}}^{\mathbf{G}}(v, v) = 0$  and  $d_{\text{Cac}}^{\mathbf{G}}(v, v') = d_{\text{Cac}}^{\mathbf{G}}(v', v)$ . Let us verify the triangle inequality. Let  $v, v', v'' \in V$  and choose two paths  $\gamma_1 : v \rightarrow v'$  and  $\gamma_2 : v' \rightarrow v''$  such that  $\min_{a \in \gamma_1} d_{\text{gr}}^G(\rho, a)$  is maximal among all paths  $\gamma : v \rightarrow v'$  in  $G$  and a similar property holds for  $\gamma_2$ . The concatenation of  $\gamma_1$  and  $\gamma_2$  gives a path  $\gamma_3 : v \rightarrow v''$  and we easily get

$$d_{\text{Cac}}^{\mathbf{G}}(v, v'') \leq d_{\text{gr}}^G(\rho, v) + d_{\text{gr}}^G(\rho, v'') - 2 \min_{a \in \gamma_3} d_{\text{gr}}^G(\rho, a) \leq d_{\text{Cac}}^{\mathbf{G}}(v, v') + d_{\text{Cac}}^{\mathbf{G}}(v', v'').$$

In order to get the bound (3.1), let  $v, v' \in V$ , and choose a geodesic path  $\gamma$  from  $v$  to  $v'$ . Let  $w$  be a point on the path  $\gamma$  whose distance to  $\rho$  is minimal. Then,

$$\begin{aligned} d_{\text{gr}}^G(v, v') &= d_{\text{gr}}^G(v, w) + d_{\text{gr}}^G(w, v') \geq d_{\text{gr}}^G(\rho, v) + d_{\text{gr}}^G(\rho, v') - 2 d_{\text{gr}}^G(\rho, w) \\ &= d_{\text{gr}}^G(\rho, v) + d_{\text{gr}}^G(\rho, v') - 2 \min_{a \in \gamma} d_{\text{gr}}^G(\rho, a) \\ &\geq d_{\text{Cac}}^{\mathbf{G}}(v, v'). \end{aligned}$$

Property (3.2) is immediate from the definition.  $\square$

As usual, we introduce the equivalence relation  $\overset{\mathbf{G}}{\sim}$  defined on  $V$  by setting  $v \overset{\mathbf{G}}{\sim} v'$  if and only  $d_{\text{Cac}}^{\mathbf{G}}(v, v') = 0$ . Note that  $v \overset{\mathbf{G}}{\sim} v'$  if and only if  $d_{\text{gr}}^G(\rho, v) = d_{\text{gr}}^G(\rho, v')$  and there exists a path from  $v$  to  $v'$  that stays at distance at least  $d_{\text{gr}}^G(\rho, v)$  from  $\rho$ .

The corresponding quotient space is denoted by  $\text{Cac}(\mathbf{G}) = V / \overset{\mathbf{G}}{\sim}$ . The pseudo-distance  $d_{\text{Cac}}^{\mathbf{G}}$  induces a distance on  $\text{Cac}(\mathbf{G})$ , and we keep the notation  $d_{\text{Cac}}^{\mathbf{G}}$  for this distance.

**Proposition 3.2.** *Consider the graph  $G^\circ$  whose vertex set is  $V^\circ = \text{Cac}(\mathbf{G})$  and whose edges are all pairs  $\{a, b\}$  such that  $d_{\text{Cac}}^{\mathbf{G}}(a, b) = 1$ . Then this graph is a tree, and the graph distance  $d_{\text{gr}}^{G^\circ}$  on  $V^\circ$  coincides with the cactus distance  $d_{\text{Cac}}^{\mathbf{G}}$  on  $\text{Cac}(\mathbf{G})$ .*

*Démonstration.* Let us first verify that the graph  $G^\circ$  is a tree. If  $u \in V$  we use the notation  $\bar{u}$  for the equivalence class of  $u$  in the quotient  $\text{Cac}(\mathbf{G})$ . We argue by contradiction and assume that there exists a (non-trivial) cycle in  $\text{Cac}(\mathbf{G})$ . We can then find

an integer  $n \geq 3$  and vertices  $x_0, x_1, x_2, \dots, x_n \in V$  such that

$$\begin{cases} \bar{x}_0 = \bar{x}_n, \\ d_{\text{Cac}}^{\mathbf{G}}(x_i, x_{i+1}) = 1, \text{ for every } 0 \leq i \leq n-1, \\ \bar{x}_0, \bar{x}_1, \dots, \bar{x}_{n-1} \text{ are distinct.} \end{cases}$$

Without loss of generality, we may assume that  $d_{\text{gr}}^G(\rho, x_0) = \max\{d_{\text{gr}}^G(\rho, x_i), 0 \leq i \leq n\}$ . By (3.2), we have  $|d_{\text{gr}}^G(\rho, x_0) - d_{\text{gr}}^G(\rho, x_1)| \leq d_{\text{Cac}}^{\mathbf{G}}(x_0, x_1) = 1$ . If  $d_{\text{gr}}^G(\rho, x_0) = d_{\text{gr}}^G(\rho, x_1)$  then it follows from the definition of  $d_{\text{Cac}}^{\mathbf{G}}$  that  $d_{\text{Cac}}^{\mathbf{G}}(x_0, x_1)$  is even and thus different from 1. So we must have

$$d_{\text{gr}}^G(\rho, x_1) = d_{\text{gr}}^G(\rho, x_0) - 1.$$

Combining this equality with the property  $d_{\text{Cac}}^{\mathbf{G}}(x_0, x_1) = 1$ , we obtain that there exists a path from  $x_0$  to  $x_1$  that stays at distance at least  $d_{\text{gr}}^G(\rho, x_1)$  from  $\rho$ .

Using the same arguments and the equality  $d_{\text{Cac}}^{\mathbf{G}}(x_0, x_{n-1}) = 1$ , we obtain similarly that  $d_{\text{gr}}^G(\rho, x_{n-1}) = d_{\text{gr}}^G(\rho, x_0) - 1 = d_{\text{gr}}^G(\rho, x_1)$  and that there exists a path from  $x_{n-1}$  to  $x_0$  that stays at distance at least  $d_{\text{gr}}^G(\rho, x_1)$  from  $\rho$ .

Considering the concatenation of the two paths we have constructed, we get that  $d_{\text{Cac}}^{\mathbf{G}}(x_1, x_{n-1})$  is equal to 0 or equivalently  $\bar{x}_1 = \bar{x}_{n-1}$ . This gives the desired contradiction, and we have proved that  $G^\circ$  is a tree.

We still have to verify the equality of the distances  $d_{\text{gr}}^{G^\circ}$  and  $d_{\text{Cac}}^{\mathbf{G}}$  on  $\text{Cac}(\mathbf{G})$ . The bound  $d_{\text{Cac}}^{\mathbf{G}} \leq d_{\text{gr}}^{G^\circ}$  is immediate from the triangle inequality for  $d_{\text{Cac}}^{\mathbf{G}}$  and the existence of a geodesic between any pair of vertices of  $G^\circ$ . Conversely, let  $a, b \in \text{Cac}(\mathbf{G})$ . We can find a path  $(y_0, y_1, \dots, y_n)$  in  $G$  such that  $\bar{y}_0 = a, \bar{y}_n = b$  and

$$d_{\text{Cac}}^{\mathbf{G}}(a, b) = d_{\text{gr}}^G(\rho, y_0) + d_{\text{gr}}^G(\rho, y_n) - 2 \min_{0 \leq j \leq n} d_{\text{gr}}^G(\rho, y_j).$$

Put  $m = \min_{0 \leq j \leq n} d_{\text{gr}}^G(\rho, y_j)$ ,  $p = d_{\text{gr}}^G(\rho, y_0)$  and  $q = d_{\text{gr}}^G(\rho, y_n)$  to simplify notation. Then set, for every  $0 \leq i \leq p - m$ ,

$$k_i = \min\{j \in \{0, 1, \dots, n\} : d_{\text{gr}}^G(\rho, y_j) = p - i\}$$

and, for every  $0 \leq i \leq q - m$ ,

$$\ell_i = \max\{j \in \{0, 1, \dots, n\} : d_{\text{gr}}^G(\rho, y_j) = q - i\}.$$

Then  $\bar{y}_{k_0}, \bar{y}_{k_1}, \dots, \bar{y}_{k_{p-m}} = \bar{y}_{\ell_{q-m}}, \bar{y}_{\ell_{q-m-1}}, \dots, \bar{y}_{\ell_1}, \bar{y}_{\ell_0}$  is a path from  $a$  to  $b$  in  $G^\circ$ . It follows that

$$d_{\text{gr}}^{G^\circ}(a, b) \leq p + q - 2m = d_{\text{Cac}}^{\mathbf{G}}(a, b),$$

which completes the proof.  $\square$

**Remark 3.3.** The notion of the cactus associated with a pointed graph strongly depends on the choice of the distinguished point  $\rho$ .

In the next sections, we will be interested in rooted planar maps, which will even be pointed in Section 3.4. With such a planar map, we can associate a pointed graph in the preceding sense : just say that  $V$  is the vertex set of the map,  $\mathcal{E}$  is the set of all pairs  $\{v, v'\}$  of distinct points of  $V$  such that there exists (at least) one edge of the map between  $v$  and  $v'$ , and the vertex  $\rho$  is either the root vertex, for a map that is only rooted, or the distinguished point for a map that is rooted and pointed. Note that the graph distance corresponding to this pointed graph (obviously) coincides with the usual graph distance on the vertex set of the map. Later, when we speak about the cactus of a planar map, we will always refer to the cactus of the associated pointed graph. In agreement with the notation of this section, we will use bold letters  $\mathbf{m}, \mathbf{M}$  to denote the pointed graphs associated with the planar maps  $m, M$ .

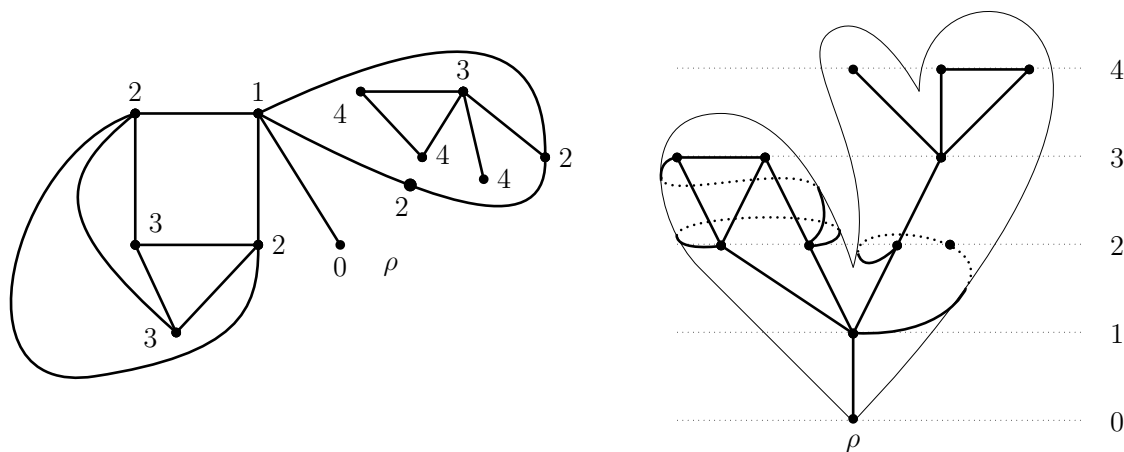

FIGURE 3.1 – A planar map and on the right side the same planar map represented so that the height of every vertex coincides with its distance from the distinguished vertex  $\rho$ . We see a tree structure emerging from this picture, which corresponds to the associated cactus.

### 3.2.2 The continuous cactus

Let us recall some basic notions from metric geometry. If  $(E, d)$  is a metric space and  $\gamma : [0, T] \rightarrow E$  is a continuous curve in  $E$ , the length of  $\gamma$  is defined by :

$$L(\gamma) = \sup_{0=t_0 < \dots < t_k=T} \sum_{i=0}^{k-1} d(\gamma(t_i), \gamma(t_{i+1})),$$

where the supremum is over all choices of the subdivision  $0 = t_0 < t_1 < \dots < t_k = T$  of  $[0, T]$ . Obviously  $L(\gamma) \geq d(\gamma(0), \gamma(T))$ .

We say that  $(E, d)$  is a geodesic space if for every  $a, b \in E$  there exists a continuous curve  $\gamma : [0, d(a, b)] \rightarrow E$  such that  $\gamma(0) = a$ ,  $\gamma(d(a, b)) = b$  and  $d(\gamma(s), \gamma(t)) = t - s$

for every  $0 \leq s \leq t \leq d(a, b)$ . Such a curve  $\gamma$  is then called a geodesic from  $a$  to  $b$  in  $E$ . Obviously,  $L(\gamma) = d(a, b)$ . A pointed geodesic metric space is a geodesic space with a distinguished point  $\rho$ .

Let  $\mathbf{E} = (E, d, \rho)$  be a pointed geodesic compact metric space. We define the (continuous) cactus associated with  $(E, d, \rho)$  in a way very similar to what we did in the discrete setting. We first define for every  $a, b \in E$ ,

$$d_{\text{Kac}}^{\mathbf{E}}(a, b) = d(\rho, a) + d(\rho, b) - 2 \sup_{\gamma: a \rightarrow b} \left( \min_{0 \leq t \leq 1} d(\rho, \gamma(t)) \right),$$

where the supremum is over all continuous curves  $\gamma : [0, 1] \rightarrow E$  such that  $\gamma(0) = a$  and  $\gamma(1) = b$ .

The next proposition is then analogous to Proposition 3.1.

**Proposition 3.4.** *The mapping  $(a, b) \rightarrow d_{\text{Kac}}^{\mathbf{E}}(a, b)$  is a pseudo-distance on  $E$ . Furthermore, for every  $a, b \in E$ ,*

$$d_{\text{Kac}}^{\mathbf{E}}(a, b) \leq d(a, b)$$

and

$$d_{\text{Kac}}^{\mathbf{E}}(\rho, a) = d(\rho, a).$$

The proof is exactly similar to that of Proposition 3.1, and we leave the details to the reader. Note that in the proof of the bound  $d_{\text{Kac}}^{\mathbf{E}}(a, b) \leq d(a, b)$  we use the existence of a geodesic from  $a$  to  $b$ .

If  $a, b \in E$ , we put  $a \stackrel{\mathbf{E}}{\sim} b$  if  $d_{\text{Kac}}^{\mathbf{E}}(a, b) = 0$ . We define the cactus of  $(E, d, \rho)$  as the quotient space  $\text{Kac}(\mathbf{E}) := E / \stackrel{\mathbf{E}}{\sim}$ , which is equipped with the quotient distance  $d_{\text{Kac}}^{\mathbf{E}}$ . Then  $\text{Kac}(\mathbf{E})$  is a compact metric space, which is pointed at the equivalence class of  $\rho$ .

**Remark 3.5.** It is natural to ask whether the supremum in the definition of  $d_{\text{Kac}}^{\mathbf{E}}(a, b)$  is achieved, or equivalently whether there is a continuous path  $\gamma$  from  $a$  to  $b$  such that

$$d_{\text{Kac}}^{\mathbf{E}}(a, b) = d(\rho, a) + d(\rho, b) - \min_{0 \leq t \leq 1} d(\rho, \gamma(t)).$$

We will return to this question later.

### 3.2.3 Continuity properties of the cactus

Let us start by recalling the definition of the Gromov-Hausdorff distance between two pointed compact metric spaces (see [75] and [40, Section 7.4] for more details).

Recall that if  $A$  and  $B$  are two compact subsets of a metric space  $(E, d)$ , the Hausdorff distance between  $A$  and  $B$  is

$$d_{\text{H}}^E(A, B) := \inf\{\varepsilon > 0 : A \subset B^\varepsilon \text{ and } B \subset A^\varepsilon\},$$

where  $X^\varepsilon := \{x \in E : d(x, X) \leq \varepsilon\}$  denotes the  $\varepsilon$ -neighborhood of a subset  $X$  of  $E$ .

**Definition 3.6.** If  $\mathbf{E} = (E, d, \rho)$  and  $\mathbf{E}' = (E', d', \rho')$  are two pointed compact metric spaces, the Gromov-Hausdorff distance between  $\mathbf{E}$  and  $\mathbf{E}'$  is

$$d_{\text{GH}}(\mathbf{E}, \mathbf{E}') = \inf \{ d_{\text{H}}^F(\phi(E), \phi'(E')) \vee \delta(\phi(\rho), \phi'(\rho')) \},$$

where the infimum is taken over all choices of the metric space  $(F, \delta)$  and the isometric embeddings  $\phi : E \rightarrow F$  and  $\phi' : E' \rightarrow F$  of  $E$  and  $E'$  into  $F$ .

The Gromov-Hausdorff distance is indeed a metric on the space of isometry classes of pointed compact metric spaces. An alternative definition of this distance uses *correspondences*. A correspondence between two pointed metric spaces  $(E, d, \rho)$  and  $(E', d', \rho')$  is a subset  $\mathcal{R}$  of  $E \times E'$  containing  $(\rho, \rho')$ , such that, for every  $x_1 \in E$ , there exists at least one point  $x_2 \in E'$  such that  $(x_1, x_2) \in \mathcal{R}$  and conversely, for every  $y_2 \in E'$ , there exists at least one point  $y_1 \in E$  such that  $(y_1, y_2) \in \mathcal{R}$ . The distortion of the correspondence  $\mathcal{R}$  is defined by

$$\text{dis}(\mathcal{R}) := \sup \{ |d(x_1, y_1) - d'(x_2, y_2)| : (x_1, x_2), (y_1, y_2) \in \mathcal{R} \}.$$

The Gromov-Hausdorff distance can be expressed in terms of correspondences by the formula

$$d_{\text{GH}}(\mathbf{E}, \mathbf{E}') = \frac{1}{2} \inf \{ \text{dis}(\mathcal{R}) \}, \tag{3.3}$$

where the infimum is over all correspondences  $\mathcal{R}$  between  $\mathbf{E}$  and  $\mathbf{E}'$ . See [40, Theorem 7.3.25] for a proof in the non-pointed case, which is easily adapted.

**Proposition 3.7.** Let  $\mathbf{E}$  and  $\mathbf{E}'$  be two pointed geodesic compact metric spaces. Then,

$$d_{\text{GH}}(\text{Kac}(\mathbf{E}), \text{Kac}(\mathbf{E}')) \leq 6 d_{\text{GH}}(\mathbf{E}, \mathbf{E}').$$

*Démonstration.* It is enough to verify that, for any correspondence  $\mathcal{R}$  between  $\mathbf{E}$  and  $\mathbf{E}'$  with distortion  $D$ , we can find a correspondence  $\mathcal{R}'$  between  $\text{Kac}(\mathbf{E})$  and  $\text{Kac}(\mathbf{E}')$  whose distortion is bounded above by  $6D$ . We define  $\mathcal{R}'$  as the set of all pairs  $(a, a')$  such that there exists (at least) one representative  $x$  of  $a$  in  $E$  and one representative  $x'$  of  $a'$  in  $E'$ , such that  $(x, x') \in \mathcal{R}$ .

Let  $(x, x') \in \mathcal{R}$  and  $(y, y') \in \mathcal{R}$ . We need to verify that

$$|d_{\text{Kac}}^{\mathbf{E}}(x, y) - d_{\text{Kac}}^{\mathbf{E}'}(x', y')| \leq 6D.$$

Fix  $\varepsilon > 0$ . We can find a continuous curve  $\gamma : [0, 1] \rightarrow E$  such that  $\gamma(0) = x$ ,  $\gamma(1) = y$  and

$$d(\rho, x) + d(\rho, y) - 2 \min_{0 \leq t \leq 1} d(\rho, \gamma(t)) \leq d_{\text{Kac}}^{\mathbf{E}}(x, y) + \varepsilon.$$

By continuity, we may find a subdivision  $0 = t_0 < t_1 < \dots < t_p = 1$  of  $[0, 1]$  such that  $d(\gamma(t_i), \gamma(t_{i+1})) \leq D$  for every  $0 \leq i \leq p-1$ . For every  $0 \leq i \leq p$ , put  $x_i = \gamma(t_i)$ , and choose  $x'_i \in E'$  such that  $(x_i, x'_i) \in \mathcal{R}$ . We may and will take  $x'_0 = x'$  and  $y'_0 = y'$ . Now note that, for  $0 \leq i \leq p-1$ ,

$$d'(x'_i, x'_{i+1}) \leq d(x_i, x_{i+1}) + D \leq 2D.$$

Since  $\mathbf{E}'$  is a geodesic space, we can find a curve  $\gamma' : [0, 1] \rightarrow E'$  such that  $\gamma'(t_i) = x'_i$ , for every  $0 \leq i \leq p$ , and any point  $\gamma'(t)$ ,  $0 \leq t \leq 1$  lies within distance at most  $D$  from one of the points  $\gamma'(t_i)$ . It follows that

$$\min_{0 \leq t \leq 1} d'(\rho', \gamma'(t)) \geq \min_{0 \leq i \leq p} d'(\rho', \gamma'(t_i)) - D \geq \min_{0 \leq i \leq p} d(\rho, \gamma(t_i)) - 2D.$$

Hence,

$$\begin{aligned} d_{\text{Kac}}^{\mathbf{E}'}(x', y') &\leq d'(\rho', x') + d'(\rho', y') - 2 \min_{0 \leq t \leq 1} d'(\rho', \gamma'(t)) \\ &\leq d(\rho, x) + d(\rho, y) - 2 \min_{0 \leq t \leq 1} d(\rho, \gamma(t)) + 6D \\ &\leq d_{\text{Kac}}^{\mathbf{E}}(x, y) + 6D + \varepsilon \end{aligned}$$

The desired result follows since  $\varepsilon$  was arbitrary and we can interchange the roles of  $\mathbf{E}$  and  $\mathbf{E}'$ .  $\square$

### 3.2.4 Convergence of discrete cactuses

Let  $\mathbf{G} = (V, \mathcal{E}, \rho)$  be a pointed graph (and write  $G = (V, \mathcal{E})$  for the non-pointed graph as previously). We can identify  $\mathbf{G}$  with the pointed (finite) metric space  $(V, d_{\text{gr}}^G, \rho)$ . For any real  $r > 0$ , we then denote the “rescaled graph”  $(V, r d_{\text{gr}}^G, \rho)$  by  $r \cdot \mathbf{G}$ .

Similarly, we defined  $\text{Cac}(\mathbf{G})$  as a pointed finite metric space. The space  $r \cdot \text{Cac}(\mathbf{G})$  is then obtained by multiplying the distance on  $\text{Cac}(\mathbf{G})$  by the factor  $r$ .

**Proposition 3.8.** *Let  $(\mathbf{G}_n)_{n \geq 0}$  be a sequence of pointed graphs, and let  $(r_n)_{n \geq 0}$  be a sequence of positive real numbers converging to 0. Suppose that  $r_n \cdot \mathbf{G}_n$  converges to a pointed compact metric space  $\mathbf{E}$ , in the sense of the Gromov-Hausdorff distance. Then,  $r_n \cdot \text{Cac}(\mathbf{G}_n)$  also converges to  $\text{Kac}(\mathbf{E})$ , in the sense of the Gromov-Hausdorff distance.*

**Remark 3.9.** The cactus  $\text{Kac}(\mathbf{E})$  is well defined because  $\mathbf{E}$  must be a geodesic space. The latter property can be derived from [40, Theorem 7.5.1], using the fact that the graphs  $r_n \cdot G_n$  can be approximated by geodesic spaces as explained in the forthcoming proof.

*Démonstration.* This is essentially a consequence of Proposition 3.7. We start with some simple observations. Let  $\mathbf{G} = (V, \mathcal{E}, \rho)$  be a pointed graph. By considering the union of a collection  $(I_{\{u,v\}})_{\{u,v\} \in \mathcal{E}}$  of unit segments indexed by  $\mathcal{E}$  (such that this union is a metric graph in the sense of [40, Section 3.2.2]), we can construct a pointed geodesic compact metric space  $(\Lambda(\mathbf{G}), d_{\Lambda(\mathbf{G})}, \tilde{\rho})$ , such that the graph  $\mathbf{G}$  (viewed as a pointed metric space) is embedded isometrically in  $\Lambda(\mathbf{G})$ , and the Gromov-Hausdorff distance between  $\mathbf{G}$  and  $\Lambda(\mathbf{G})$  is bounded above by 1.

A moment’s thought shows that  $\text{Cac}(\mathbf{G})$  is also embedded isometrically in  $\text{Kac}(\Lambda(\mathbf{G}))$ , and the Gromov-Hausdorff distance between  $\text{Cac}(\mathbf{G})$  and  $\text{Kac}(\Lambda(\mathbf{G}))$  is still bounded above by 1.

We apply these observations to the graphs  $\mathbf{G}_n$ . By scaling, we get that the Gromov-Hausdorff distance between the metric spaces  $r_n \cdot \mathbf{G}_n$  and  $r_n \cdot \Lambda(\mathbf{G}_n)$  is bounded above

by  $r_n$ , so that the sequence  $r_n \cdot \Lambda(\mathbf{G}_n)$  also converges to  $\mathbf{E}$  in the sense of the Gromov-Hausdorff distance. From Proposition 3.7, we now get that  $\text{Kac}(r_n \cdot \Lambda(\mathbf{G}_n))$  converges to  $\text{Kac}(\mathbf{E})$ . On the other hand, the Gromov-Hausdorff distance between  $\text{Kac}(r_n \cdot \Lambda(\mathbf{G}_n)) = r_n \cdot \text{Kac}(\Lambda(\mathbf{G}_n))$  and  $r_n \cdot \text{Cac}(\mathbf{G}_n)$  is bounded above by  $r_n$ , so that the convergence of the proposition follows.  $\square$

**Corollary 3.10.** *Let  $\mathbf{E}$  be a pointed geodesic compact metric space. Then  $\text{Kac}(\mathbf{E})$  is a compact  $\mathbb{R}$ -tree.*

*Démonstration.* As a simple consequence of Proposition 7.5.5 in [40], we can find a sequence  $(r_n)_{n \geq 0}$  of positive real numbers converging to 0 and a sequence  $(\mathbf{G}_n)_{n \geq 0}$  of pointed graphs, such that the rescaled graphs  $r_n \cdot \mathbf{G}_n$  converge to  $\mathbf{E}$  in the Gromov-Hausdorff sense. By Proposition 3.8,  $r_n \cdot \text{Cac}(\mathbf{G}_n)$  converges to  $\text{Kac}(\mathbf{E})$  in the Gromov-Hausdorff sense. Using the notation of the preceding proof, it also holds that  $r_n \cdot \Lambda(\text{Cac}(\mathbf{G}_n))$  converges to  $\text{Kac}(\mathbf{E})$ . Proposition 3.2 then implies that  $r_n \cdot \Lambda(\text{Cac}(\mathbf{G}_n))$  is a (compact)  $\mathbb{R}$ -tree. The desired result follows since the set of all compact  $\mathbb{R}$ -trees is known to be closed for the Gromov-Hausdorff topology (see e.g. [64, Lemma 2.1]).  $\square$

### 3.2.5 Another approach to the continuous cactus

In this section, we present an alternative definition of the continuous cactus, which gives a different perspective on the previous results, and in particular on Corollary 3.10. Let  $\mathbf{E} = (E, d, \rho)$  be a pointed geodesic compact metric space, and for  $r \geq 0$ , let

$$\mathbf{B}(r) = \{x \in E : d(\rho, x) < r\}, \quad \overline{\mathbf{B}}(r) = \{x \in E : d(\rho, x) \leq r\},$$

be respectively the open and the closed ball of radius  $r$  centered at  $\rho$ . We let  $\text{Kac}'(\mathbf{E})$  be the set of all subsets of  $E$  that are (non-empty) connected components of the closed set  $\mathbf{B}(r)^c$ , for some  $r \geq 0$  (here,  $A^c$  denotes the complement of the set  $A$ ). Note that all elements of  $\text{Kac}'(\mathbf{E})$  are themselves closed subsets of  $E$ .

For every  $C \in \text{Kac}'(\mathbf{E})$ , we let

$$h(C) = d(\rho, C) = \inf\{d(\rho, x) : x \in C\}.$$

Since  $E$  is path-connected,  $h(C)$  is also the unique real  $r \geq 0$  such that  $C$  is a connected component of  $\mathbf{B}(r)^c$ .

Note that  $\text{Kac}'(\mathbf{E})$  is partially ordered by the relation

$$C \preceq C' \iff C' \subseteq C$$

and has a unique minimal element  $E$ . Every totally ordered subset of  $\text{Kac}'(\mathbf{E})$  has a supremum, given by the intersection of all its elements. To see this, observe that if  $(C_i)_{i \in I}$  is a totally ordered subset of  $\text{Kac}'(\mathbf{E})$  then we can choose a sequence  $(i_n)_{n \geq 1}$  taking values in  $I$  such that the sequence  $(h(C_{i_n}))_{n \geq 1}$  is non-decreasing and converges to  $r_{\max} := \sup\{h(C_i) : i \in I\}$ . Then the intersection

$$\bigcap_{n=1}^{\infty} C_{i_n}$$



is non-empty, closed and connected as the intersection of a decreasing sequence of non-empty closed connected sets in a compact space, and it easily follows that this intersection is a connected component of  $\mathbf{B}(r_{\max})^c$  and coincides with the intersection of all  $C_i$ ,  $i \in I$ . At this point, it is crucial that elements of  $\text{Kac}'(\mathbf{E})$  are closed, and this is one of the reasons why one considers complements of *open* balls in the definition of  $\text{Kac}'(\mathbf{E})$ .

In particular, for every  $C, C' \in \text{Kac}'(\mathbf{E})$ , the infimum  $C \wedge C'$  makes sense as the supremum of all  $C'' \in \text{Kac}'(\mathbf{E})$  such that  $C'' \preceq C$  and  $C'' \preceq C'$ , and  $h(C \wedge C')$  is the maximal value of  $r$  such that  $C$  and  $C'$  are contained in the same connected component of  $\mathbf{B}(r)^c$ .

Moreover, if  $C \in \text{Kac}'(\mathbf{E})$ , the set  $\{C' \in \text{Kac}'(\mathbf{E}) : C' \preceq C\}$  is isomorphic as an ordered set to the segment  $[0, h(C)]$ , because for every  $t \in [0, h(C)]$  there is a unique  $C' \in \text{Kac}'(\mathbf{E})$  with  $h(C') = t$  and  $C \subset C'$ .

Finally,  $h : \text{Kac}'(\mathbf{E}) \rightarrow \mathbb{R}_+$  is an increasing function, inducing a bijection from every segment of the partially ordered set  $\text{Kac}'(\mathbf{E})$  to a real segment. It follows from general results (see Proposition 3.10 in [65]) that the set  $\text{Kac}'(\mathbf{E})$  equipped with the distance

$$d_{\text{Kac}'}^{\mathbf{E}}(C, C') = h(C) + h(C') - 2h(C \wedge C')$$

is an  $\mathbb{R}$ -tree rooted at  $E = \mathbf{B}(0)^c$ . Note that  $d_{\text{Kac}'}^{\mathbf{E}}(E, C) = h(C)$  for every  $C \in \text{Kac}'(\mathbf{E})$ .

**Proposition 3.11.** *The spaces  $\text{Kac}'(\mathbf{E})$  and  $\text{Kac}(\mathbf{E})$  are isometric pointed metric spaces.*

*Démonstration.* We consider the mapping from  $E$  to  $\text{Kac}'(\mathbf{E})$ , which maps  $x$  to the connected component  $C_x$  of  $\mathbf{B}(d(\rho, x))^c$  containing  $x$ . This mapping is clearly onto : if  $C \in \text{Kac}'(\mathbf{E})$ , we have  $C = C_x$  for any  $x \in C$  such that  $d(\rho, x) = d(\rho, C)$ . Let us show that this mapping is an isometry from the pseudo-metric space  $(E, d_{\text{Kac}}^{\mathbf{E}})$  onto  $(\text{Kac}'(\mathbf{E}), d_{\text{Kac}'}^{\mathbf{E}})$ .

Let  $x, y \in E$  be given, and  $\gamma : [0, 1] \rightarrow E$  be a path from  $x$  to  $y$ . Let  $t_0$  be such that  $d(\rho, \gamma(t_0)) \leq d(\rho, \gamma(t))$  for every  $t \in [0, 1]$ . Then the path  $\gamma$  lies in a single path-connected component of  $\mathbf{B}(d(\rho, \gamma(t_0)))^c$ , entailing that  $x$  and  $y$  are in the same connected component of this set. Consequently,  $h(C_x \wedge C_y) \geq d(\rho, \gamma(t_0))$ , and since obviously  $h(C_x) = d(x, \rho)$ ,

$$d_{\text{Kac}'}^{\mathbf{E}}(C_x, C_y) \leq d(\rho, x) + d(\rho, y) - 2 \inf_{t \in [0, 1]} d(\rho, \gamma(t)).$$

Taking the infimum over all  $\gamma$  gives

$$d_{\text{Kac}'}^{\mathbf{E}}(C_x, C_y) \leq d_{\text{Kac}}^{\mathbf{E}}(x, y). \tag{3.4}$$

Let us verify that the reverse inequality also holds. If  $h(C_x \wedge C_y) > 0$  and  $\varepsilon \in (0, h(C_x \wedge C_y))$ , the infimum  $C_x \wedge C_y$  is contained in some connected component of  $\overline{\mathbf{B}}(h(C_x \wedge C_y) - \varepsilon)^c$ . Since the latter set is open, and  $E$  is a geodesic space, hence locally path-connected, we deduce that this connected component is in fact path-connected, and since it contains  $x$  and  $y$ , we can find a path  $\gamma$  from  $x$  to  $y$  that remains in  $\overline{\mathbf{B}}(h(C_x \wedge C_y) - \varepsilon)^c$ . This entails that

$$d_{\text{Kac}}^{\mathbf{E}}(x, y) \leq d_{\text{Kac}'}^{\mathbf{E}}(C_x, C_y) + \varepsilon,$$

and letting  $\varepsilon \rightarrow 0$  yields the bound  $d_{\text{Kac}'}^{\mathbf{E}}(C_x, C_y) \geq d_{\text{Kac}}^{\mathbf{E}}(x, y)$ . The latter bound remains true when  $h(C_x \wedge C_y) = 0$ , since in that case  $C_x \wedge C_y = E$  and  $d_{\text{Kac}'}^{\mathbf{E}}(C_x, C_y) = h(C_x) + h(C_y) = d(\rho, x) + d(\rho, y)$ .

From the preceding observations, we directly obtain that  $x \mapsto C_x$  induces a quotient mapping from  $\text{Kac}(\mathbf{E})$  onto  $\text{Kac}'(\mathbf{E})$ , which is an isometry and maps (the class of)  $\rho$  to  $E$ .  $\square$

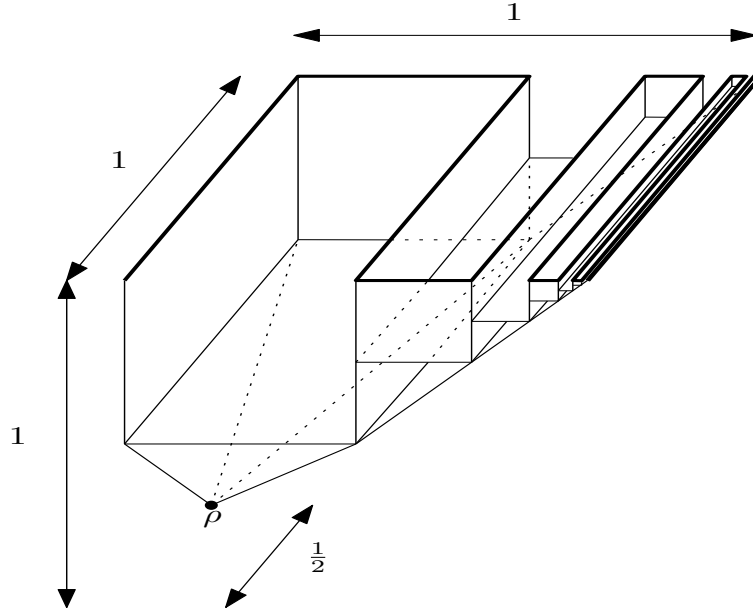

FIGURE 3.2 – An example of a geodesic compact metric space  $E$ , such that the complement of the open ball of radius 1 centered at the distinguished point  $\rho$  is connected but not path-connected. Here  $E$  is a compact subset of  $\mathbb{R}^3$  and is equipped with the intrinsic distance associated with the  $L^\infty$ -metric  $\delta((x_1, x_2, x_3), (y_1, y_2, y_3)) = \sup\{|x_i - y_i|, i = 1, 2, 3\}$ . For this distance, the sphere of radius 1 centered at  $\rho$ , which coincides with the complement of the open ball of radius 1, consists of the union of the bold lines at the top of the figure.

**Remark 3.12.** The discrete cactus of a graph can be defined in an analogous way as above, using the notion of graph connectedness instead of connectedness in metric spaces.

Let us return to Remark 3.5 about the existence, for given  $x, y \in E$ , of a minimizing path  $\gamma : [0, 1] \rightarrow E$  going from  $x$  to  $y$ , such that

$$d_{\text{Kac}}^{\mathbf{E}}(x, y) = d(\rho, x) + d(\rho, y) - 2 \min_{0 \leq t \leq 1} d(\rho, \gamma(t)).$$

With the notation of the previous proof, it may happen that the closed set  $C_x \wedge C_y$  is connected without being path-connected : Fig.2 suggests an example of this phenome-

non. In that event, if  $x$  and  $y$  cannot be connected by a continuous path that stays in  $C_x \wedge C_y$ , there exists no minimizing path.

### 3.3 The Brownian cactus

In this section, we define the Brownian cactus and we show that it is the continuous cactus associated with the (random) compact metric space called the Brownian map. The Brownian map has been studied in [98] as the limit in distribution, along suitable sequences, of rescaled  $2p$ -angulations chosen uniformly at random. We first recall some basic facts about the Brownian map.

We let  $\mathbf{e} = (\mathbf{e}_t)_{0 \leq t \leq 1}$  be a Brownian excursion with duration 1. For our purposes it is crucial to view  $\mathbf{e}$  as the coding function for the random continuous tree known as the CRT. Precisely, we define a pseudo-distance  $d_{\mathbf{e}}$  on  $[0, 1]$  by setting for every  $s, t \in [0, 1]$ ,

$$d_{\mathbf{e}}(s, t) = \mathbf{e}_s + \mathbf{e}_t - 2 \min_{s \wedge t \leq r \leq s \vee t} \mathbf{e}_r$$

and we put  $s \sim_{\mathbf{e}} t$  iff  $d_{\mathbf{e}}(s, t) = 0$ . The CRT is defined as the quotient metric space  $\mathcal{T}_{\mathbf{e}} := [0, 1] / \sim_{\mathbf{e}}$ , and is equipped with the induced metric  $d_{\mathbf{e}}$ . Then  $(\mathcal{T}_{\mathbf{e}}, d_{\mathbf{e}})$  is a random (compact)  $\mathbb{R}$ -tree. We write  $p_{\mathbf{e}} : [0, 1] \rightarrow \mathcal{T}_{\mathbf{e}}$  for the canonical projection, and we define the mass measure (or volume measure)  $\text{Vol}$  on the CRT as the image of Lebesgue measure on  $[0, 1]$  under  $p_{\mathbf{e}}$ . For every  $a, b \in \mathcal{T}_{\mathbf{e}}$ , we let  $[[a, b]]$  be the range of the geodesic path from  $a$  to  $b$  in  $\mathcal{T}_{\mathbf{e}}$ : This is the line segment between  $a$  and  $b$  in the tree  $\mathcal{T}_{\mathbf{e}}$ . We will need the following simple fact, which is easily checked from the definition of  $d_{\mathbf{e}}$ . Let  $a, b \in \mathcal{T}_{\mathbf{e}}$ , and let  $s, t \in [0, 1]$  be such that  $p_{\mathbf{e}}(s) = a$  and  $p_{\mathbf{e}}(t) = b$ . Assume for definiteness that  $s \leq t$ . Then  $[[a, b]]$  exactly consists of the points  $c$  that can be written as  $c = p_{\mathbf{e}}(r)$ , with  $r \in [s, t]$  satisfying

$$\mathbf{e}_r = \max \left( \min_{u \in [s, r]} \mathbf{e}_u, \min_{u \in [r, t]} \mathbf{e}_u \right).$$

Conditionally given  $\mathbf{e}$ , we introduce the centered Gaussian process  $(Z_t)_{0 \leq t \leq 1}$  with continuous sample paths such that

$$\text{cov}(Z_s, Z_t) = \min_{s \wedge t \leq r \leq s \vee t} \mathbf{e}_r.$$

It is easy to verify that a.s. for every  $s, t \in [0, 1]$  the condition  $s \sim_{\mathbf{e}} t$  implies that  $Z_s = Z_t$ . Therefore we may and will view  $Z$  as indexed by the CRT  $\mathcal{T}_{\mathbf{e}}$ . In fact, it is natural to interpret  $Z$  as Brownian motion indexed by the CRT. We will write indifferently  $Z_a = Z_t$  when  $a \in \mathcal{T}_{\mathbf{e}}$  and  $t \in [0, 1]$  are such that  $a = p_{\mathbf{e}}(t)$ .

We set

$$\underline{Z} := \min_{t \in [0, 1]} Z_t.$$

One can then prove [110, 103] that a.s. there exists a unique  $s_* \in [0, 1]$  such that  $Z_{s_*} = \underline{Z}$ . We put

$$a_* = p_{\mathbf{e}}(s_*).$$

We now define an equivalence relation on the CRT. For every  $a, b \in \mathcal{T}_e$ , we put  $a \approx b$  if and only if there exist  $s, t \in [0, 1]$  such that  $p_e(s) = a$ ,  $p_e(t) = b$ , and

$$Z_r \geq Z_s = Z_t, \quad \text{for every } r \in [s, t].$$

Here and later we make the convention that when  $s > t$ , the notation  $r \in [s, t]$  means  $r \in [s, 1] \cup [0, t]$ .

It is not obvious that  $\approx$  is an equivalence relation. This follows from Lemma 3.2 in [102], which shows that with probability one, for every distinct  $a, b \in \mathcal{T}_e$ , the property  $a \approx b$  may only hold if  $a$  and  $b$  are leaves of  $\mathcal{T}_e$ , and then  $p_e^{-1}(a)$  and  $p_e^{-1}(b)$  are both singletons.

The Brownian map is now defined as the quotient space

$$m_\infty := \mathcal{T}_e / \approx$$

which is equipped with the quotient topology. We write  $\Pi : \mathcal{T}_e \rightarrow m_\infty$  for the canonical projection, and we put  $\rho_* = \Pi(a_*)$ . We also let  $\lambda$  be the image of  $\text{Vol}$  under  $\Pi$ , and we interpret  $\lambda$  as the volume measure on  $m_\infty$ . For every  $x \in m_\infty$ , we set  $Z_x = Z_a$ , where  $a \in \mathcal{T}_e$  is such that  $\Pi(a) = x$  (this definition does not depend on the choice of  $a$ ).

A key result of [98] states the Brownian map, equipped with a suitable metric  $D$ , appears as the limit in distribution of rescaled random  $2p$ -angulations. More precisely, let  $p \geq 2$  be an integer, and for every  $n \geq 1$ , let  $m_n$  be uniformly distributed over the class of all rooted  $2p$ -angulations with  $n$  faces. Write  $V(m_n)$  for the vertex set of  $m_n$ , which is equipped with the graph distance  $d_{\text{gr}}^{m_n}$ , and let  $\rho_n$  denote the root vertex of  $m_n$ . Then, from any strictly increasing sequence of positive integers we can extract a suitable subsequence  $(n_k)_{k \geq 1}$  such that the following convergence holds in distribution in the Gromov-Hausdorff sense,

$$\left( V(m_{n_k}), \left( \frac{9}{4p(p-1)} \right)^{1/4} (n_k)^{-1/4} d_{\text{gr}}^{m_{n_k}}, \rho_{n_k} \right) \xrightarrow[k \rightarrow \infty]{(d)} (m_\infty, D, \rho_*) \quad (3.5)$$

where  $D$  is a metric on the space  $m_\infty$  that satisfies the following properties :

1. For every  $a \in \mathcal{T}_e$ ,

$$D(\rho_*, \Pi(a)) = Z_a - \underline{Z}.$$

2. For every  $a, b \in \mathcal{T}_e$  and every  $s, t \in [0, 1]$  such that  $p_e(s) = a$  and  $p_e(t) = b$ ,

$$D(\Pi(a), \Pi(b)) \leq Z_s + Z_t - 2 \min_{r \in [s, t]} Z_r.$$

3. For every  $a, b \in \mathcal{T}_e$ ,

$$D(\Pi(a), \Pi(b)) \geq Z_a + Z_b - 2 \min_{c \in [a, b]} Z_c.$$

Notice that in Property 2 we make the same convention as above for the notation  $r \in [s, t]$  when  $s > t$ . The preceding statements can be found in Section 3 of [98] (see in particular [98, Theorem 3.4]), with the exception of Property 3. We refer to Corollary

3.2 in [99] for the latter property. By the argument in Remark 3.9, the metric space  $(m_\infty, D)$  is a geodesic space a.s.

The limiting metric  $D$  in (3.5) may depend on the integer  $p$  and on the choice of the subsequence  $(n_k)$ . However, we will see that the cactus of the Brownian map is well defined independently of  $p$  and of the chosen subsequence, and in fact coincides with the Brownian cactus that we now introduce.

**Definition 3.13.** *The Brownian cactus KAC is the random metric space defined as the quotient space of  $\mathcal{T}_e$  for the equivalence relation*

$$a \asymp b \quad \text{iff} \quad Z_a = Z_b = \min_{c \in [a,b]} Z_c$$

and equipped with the distance induced by

$$d_{\text{KAC}}(a, b) = Z_a + Z_b - 2 \min_{c \in [a,b]} Z_c, \quad \text{for every } a, b \in \mathcal{T}_e.$$

We view KAC as a pointed metric space whose root is the equivalence class of  $a_*$ .

It is an easy matter to verify that  $d_{\text{KAC}}$  is a pseudo-distance on  $\mathcal{T}_e$ , and that  $\asymp$  is the associated equivalence relation.

We write  $\mathbf{m}_\infty$  for the pointed metric space  $(m_\infty, D, \rho_*)$  appearing in (3.5).

**Proposition 3.14.** *Almost surely,  $\text{Kac}(\mathbf{m}_\infty)$  is isometric to KAC.*

*Démonstration.* We first need to identify the pseudo-distance  $d_{\text{Kac}}^{\mathbf{m}_\infty}$  (see subsection 3.2.2). Let  $x, y \in m_\infty$  and choose  $a, b \in \mathcal{T}_e$  such that  $x = p_e(a)$  and  $y = p_e(b)$ . If  $\gamma : [0, 1] \rightarrow m_\infty$  is a continuous path such that  $\gamma(0) = x$  and  $\gamma(1) = y$ , Proposition 3.1 in [99] ensures that

$$\min_{0 \leq t \leq 1} Z_{\gamma(t)} \leq \min_{c \in [a,b]} Z_c.$$

Using Property 1 above, it follows that

$$\min_{0 \leq t \leq 1} D(\rho_*, \gamma(t)) \leq \min_{c \in [a,b]} (Z_c - \underline{Z}).$$

Since this holds for any continuous curve  $\gamma$  from  $x$  to  $y$  in  $m_\infty$ , we get from the definition of  $d_{\text{Kac}}^{\mathbf{m}_\infty}$  that

$$d_{\text{Kac}}^{\mathbf{m}_\infty}(x, y) \geq (Z_a - \underline{Z}) + (Z_b - \underline{Z}) - 2 \min_{c \in [a,b]} (Z_c - \underline{Z}) = d_{\text{KAC}}(a, b).$$

The corresponding upper bound is immediately obtained by letting  $\gamma$  be the image under  $\Pi$  of the (rescaled) geodesic path from  $a$  to  $b$  in the tree  $\mathcal{T}_e$ . Note that the resulting path from  $x$  to  $y$  in  $m_\infty$  is continuous because the projection  $\Pi$  is so. Summarizing, we have obtained that, for every  $a, b \in \mathcal{T}_e$ ,

$$d_{\text{Kac}}^{\mathbf{m}_\infty}(\Pi(a), \Pi(b)) = d_{\text{KAC}}(a, b). \tag{3.6}$$

In particular, the property  $a \asymp b$  holds if and only if  $\Pi(a) \stackrel{\mathbf{m}_\infty}{\asymp} \Pi(b)$ . Hence, the composition of the canonical projections from  $\mathcal{T}_e$  onto  $m_\infty$  and from  $m_\infty$  onto  $\text{Kac}(\mathbf{m}_\infty)$  induces a one to-one mapping from  $\text{KAC} = \mathcal{T}_e / \asymp$  onto  $\text{Kac}(\mathbf{m}_\infty)$ . By (3.6) this mapping is an isometry, which completes the proof.  $\square$

Recall the notation  $m_n$  for a random planar map uniformly distributed over the set of all rooted  $2p$ -angulations with  $n$  faces, and  $\rho_n$  for the root vertex of  $m_n$ . As explained at the end of subsection 3.2.1, we can associate a pointed graph with  $m_n$ , such that the distinguished point of this graph is  $\rho_n$ . We write  $\mathbf{m}_n$  for this pointed graph.

**Corollary 3.15.** *We have*

$$\left(\frac{9}{4p(p-1)}\right)^{1/4} n^{-1/4} \cdot \text{Cac}(\mathbf{m}_n) \xrightarrow[n \rightarrow \infty]{(d)} \text{KAC}$$

*in the Gromov-Hausdorff sense.*

In contrast with (3.5), the convergence of the corollary does not require the extraction of a subsequence.

*Démonstration.* It is sufficient to prove that, from any strictly increasing sequence of positive integers we can extract a subsequence  $(n_k)$  such that the desired convergence holds along this subsequence. To this end, we extract the subsequence  $(n_k)$  so that (3.5) holds. By Proposition 3.8, we have then

$$\left(\frac{9}{4p(p-1)}\right)^{1/4} (n_k)^{-1/4} \cdot \text{Cac}(\mathbf{m}_{n_k}) \xrightarrow[k \rightarrow \infty]{(d)} \text{Kac}(\mathbf{m}_\infty).$$

By Proposition 3.14, the limiting distribution is that of KAC, independently of the subsequence that we have chosen. This completes the proof.  $\square$

In the next section, we will see that the convergence of the corollary holds for much more general random planar maps.

### 3.4 Convergence of cactuses associated with random planar maps

#### 3.4.1 Planar maps and bijections with trees

We denote the set of all rooted and pointed planar maps by  $\mathcal{M}_{r,p}$ . As in [114], it is convenient for technical reasons to make the convention that  $\mathcal{M}_{r,p}$  contains the “vertex map”, denoted by  $\dagger$ , which has no edge and only one vertex “bounding” a face of degree 0. With the exception of  $\dagger$ , a planar map in  $\mathcal{M}_{r,p}$  has at least one edge. An element of  $\mathcal{M}_{r,p}$  other than  $\dagger$  consists of a planar map  $m$  together with an oriented edge  $e$  (the root edge) and a distinguished vertex  $\rho$ . We write  $e_-$  and  $e_+$  for the origin and the target of the root edge  $e$ . Note that we may have  $e_- = e_+$  if  $e$  is a loop.

As previously, we denote the graph distance on the vertex set  $V(m)$  of  $m$  by  $d_{\text{gr}}^m$ . We say that the rooted and pointed planar map  $(m, e, \rho)$  is positive, respectively negative, respectively null if  $d_{\text{gr}}^m(\rho, e_+) = d_{\text{gr}}^m(\rho, e_-) + 1$ , resp.  $d_{\text{gr}}^m(\rho, e_+) = d_{\text{gr}}^m(\rho, e_-) - 1$ , resp.  $d_{\text{gr}}^m(\rho, e_+) = d_{\text{gr}}^m(\rho, e_-)$ . We make the convention that the vertex map  $\dagger$  is positive. We write  $\mathcal{M}_{r,p}^+$ , resp.  $\mathcal{M}_{r,p}^-$ , resp.  $\mathcal{M}_{r,p}^0$  for the set of all positive, resp. negative, resp. null, rooted and pointed planar maps. Reversing the orientation of the root edge yields an obvious bijection between the sets  $\mathcal{M}_{r,p}^+$  and  $\mathcal{M}_{r,p}^-$ , and for this reason we will mainly discuss  $\mathcal{M}_{r,p}^+$  and  $\mathcal{M}_{r,p}^0$  in what follows.

We will make use of the Bouttier-Di Francesco-Guitter bijection [32] between  $\mathcal{M}_{r,p}^+ \cup \mathcal{M}_{r,p}^0$  and a certain set of multitype labeled trees called mobiles. In order to describe this bijection, we use the standard formalism for plane trees, as found in Section 1.1 of [97] for instance. In this formalism, vertices are elements of the set

$$\mathcal{U} = \bigcup_{n=0}^{\infty} \mathbb{N}^n$$

of all finite sequences of positive integers, including the empty sequence  $\emptyset$  that serves as the root vertex of the tree. A plane tree  $\tau$  is a finite subset of  $\mathcal{U}$  that satisfies the following three conditions :

1.  $\emptyset \in \tau$ .
2. For every  $u = (i_1, \dots, i_k) \in \tau \setminus \{\emptyset\}$ , the sequence  $(i_1, \dots, i_{k-1})$  (the “parent” of  $u$ ) also belongs to  $\tau$ .
3. For every  $u = (i_1, \dots, i_k) \in \tau$ , there exists an integer  $k_u(\tau) \geq 0$  (the “number of children” of  $u$ ) such that the vertex  $(i_1, \dots, i_k, j)$  belongs to  $\tau$  if and only if  $1 \leq j \leq k_u(\tau)$ .

The generation of  $u = (i_1, \dots, i_k)$  is denoted by  $|u| = k$ . The notions of an ancestor and a descendant in the tree  $\tau$  are defined in an obvious way.

We will be interested in four-type plane trees, meaning that each vertex is assigned a type which can be 1, 2, 3 or 4.

We next introduce mobiles following the presentation in [114], with a few minor modifications. We consider a four-type plane tree  $\tau$  satisfying the following properties :

- (i) The root vertex  $\emptyset$  is of type 1 or of type 2.
- (ii) The children of any vertex of type 1 are of type 3.
- (iii) Each individual of type 2 and which is not the root vertex of the tree has exactly one child of type 4 and no other child. If the root vertex is of type 2, it has exactly two children, both of type 4.
- (iv) The children of individuals of type 3 or 4 can only be of type 1 or 2.

Let  $\tau_{(1,2)}$  be the set of all vertices of  $\tau$  at even generation (these are exactly the vertices of type 1 or 2). An admissible labeling of  $\tau$  is a collection of integer labels  $(\ell_u)_{u \in \tau_{(1,2)}}$  assigned to the vertices of type 1 or 2, such that the following properties hold :

- a.  $\ell_{\emptyset} = 0$ .
- b. Let  $u$  be a vertex of type 3 or 4, let  $u_{(1)}, \dots, u_{(k)}$  be the children of  $u$  (in lexicographical order) and let  $u_{(0)}$  be the parent of  $u$ . Then, for every  $i = 0, 1, \dots, k$ ,

$$\ell_{u_{(i+1)}} \geq \ell_{u_{(i)}} - 1$$

with the convention  $u_{(k+1)} = u_{(0)}$ . Moreover, for every  $i = 0, 1, \dots, k$  such that  $u_{(i+1)}$  is of type 2, we have

$$\ell_{u_{(i+1)}} \geq \ell_{u_{(i)}}.$$

By definition, a *mobile* is a pair  $(\tau, (\ell_u)_{u \in \tau_{(1,2)}})$  consisting of a four-type plane tree satisfying the preceding conditions (i)–(iv), and an admissible labeling of  $\tau$ . We let  $\mathbb{T}_+$  be the set of all mobiles such that the root vertex of  $\tau$  is of type 1. We also let  $\mathbb{T}_0$  be the set of all mobiles such that the root vertex is of type 2.

**Remark 3.16.** Our definition of admissible labelings is slightly different from the ones that are used in [114] or [119]. To recover the definitions of [114] or [119], just subtract 1 from the label of each vertex of type 2. Because of this difference, our construction of the bijections between maps and trees will look slightly different from the ones in [114] or [119].

The Bouttier-Di Francesco-Guitter construction provides bijections between the set  $\mathbb{T}_+$  and the set  $\mathcal{M}_{r,p}^+$  on one hand, between the set  $\mathbb{T}_0$  and the set  $\mathcal{M}_{r,p}^0$  on the other hand. Let us describe this construction in the first case.

We start from a mobile  $(\tau, (\ell_u)_{u \in \tau_{(1,2)}}) \in \mathbb{T}_+$ . In the case when  $\tau = \{\emptyset\}$ , we decide by convention that the associated planar map is the vertex map  $\dagger$ . Otherwise, let  $p \geq 1$  be the number of edges of  $\tau$  ( $p = \#\tau - 1$ ). The contour sequence of  $\tau$  is the sequence  $v_0, v_1, \dots, v_{2p}$  of vertices of  $\tau$  defined inductively as follows. First  $v_0 = \emptyset$ . Then, for every  $i \in \{0, 1, \dots, 2p - 1\}$ ,  $v_{i+1}$  is either the first child of  $v_i$  that has not yet appeared among  $v_0, v_1, \dots, v_i$ , or if there is no such child, the parent of  $v_i$ . It is easy to see that this definition makes sense and  $v_{2p} = \emptyset$ . Moreover all vertices of  $\tau$  appear in the sequence  $v_0, v_1, \dots, v_{2p}$ , and more precisely the number of occurrences of a vertex  $u$  of  $\tau$  is equal to the multiplicity of  $u$  in  $\tau$ . In fact, each index  $i$  such that  $v_i = u$  corresponds to one corner of the vertex  $u$  in the tree  $\tau$ : We will abusively call it the corner  $v_i$ . We also introduce the modified contour sequence of  $\tau$  as the sequence  $u_0, u_1, \dots, u_p$  defined by

$$u_i = v_{2i}, \quad \forall i = 0, 1, \dots, p.$$

By construction, the vertices appearing in the modified contour sequence are exactly the vertices of  $\tau_{(1,2)}$ . We extend the modified contour sequence periodically by setting  $u_{p+i} = u_i$  for  $i = 1, \dots, p$ . Note that the properties of labels entail  $\ell_{u_{i+1}} \geq \ell_{u_i} - 1$  for  $i = 0, 1, \dots, 2p - 1$ .

To construct the edges of the rooted and pointed planar map  $(m, e, \rho)$  associated with the mobile  $(\tau, (\ell_u)_{u \in \tau_{(1,2)}}) \in \mathbb{T}_+$  we proceed as follows. We first embed the tree  $\tau$  in the plane in a way consistent with the planar order. We then add an extra vertex of type 1, which we call  $\rho$ . Then, for every  $i = 0, 1, \dots, p - 1$ :

(i) If

$$\ell_{u_i} = \min_{0 \leq k \leq p} \ell_{u_k}$$

we draw an edge between the corner  $u_i$  and  $\rho$ .

(ii) If

$$\ell_{u_i} > \min_{0 \leq k \leq p} \ell_{u_k}$$

we draw an edge between the corner  $u_i$  and the corner  $u_j$ , where  $j = \min\{k \in \{i + 1, \dots, i + p - 1\} : \ell_{u_k} = \ell_{u_i} - 1\}$ . Because of property b. of the labeling, the vertex  $u_j$  must be of type 1.



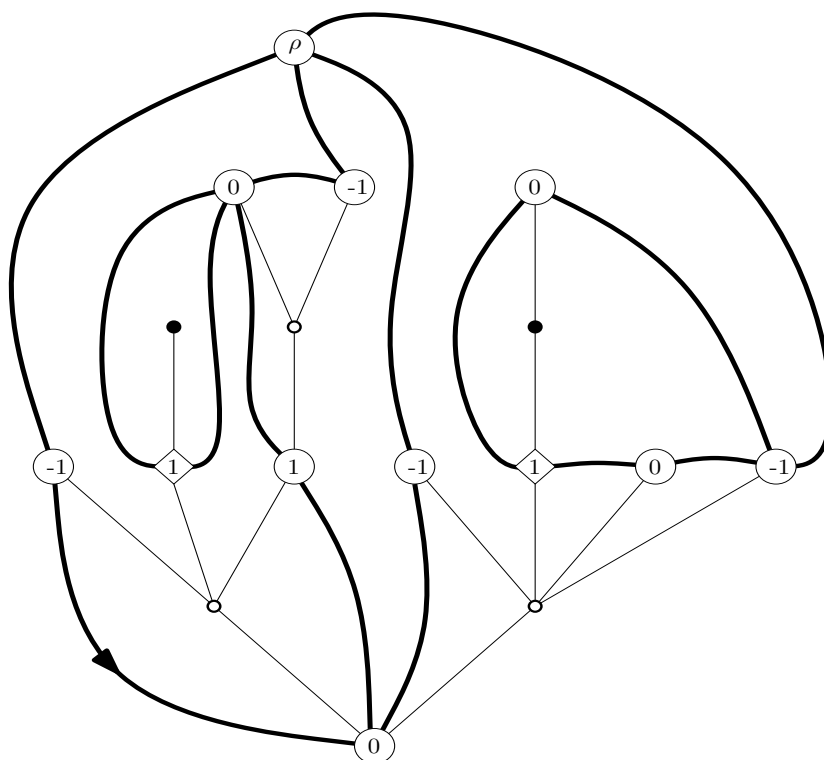

FIGURE 3.3 – A mobile  $(\tau, (\ell_u)_{u \in \tau(1,2)})$  in  $\mathbb{T}_+$  and its image  $m$  under the BDG bijection. Vertices of type 1 are represented by big circles, vertices of type 2 by lozanges, vertices of type 3 by small circles and vertices of type 4 by small black disks. The edges of the tree  $\tau$  are represented by thin lines, and the edges of the planar map  $m$  by thick curves. In order to get the planar map  $m$  one needs to erase the vertices of type 2 and, for each of these vertices, to merge its two incident edges into a single one. The root edge is at the bottom left.

The construction can be made in such a way that edges do not intersect, and do not intersect the edges of the tree  $\tau$ . Furthermore each face of the resulting planar map contains exactly one vertex of type 3 or 4, and both the parent and the children of this vertex are incident to this face. See Fig.2 for an example.

The resulting planar map is bipartite with vertices either of type 1 or of type 2. Furthermore, the fact that in the tree  $\tau$  each vertex of type 2 has exactly one child, and the labeling rules imply that each vertex of type 2 is incident to exactly two edges of the map, which connect it to two vertices of type 1, which may be the same (these vertices of type 1 will be said to be associated with the vertex of type 2 we are considering). Each of these edges corresponds in the preceding construction to one of the two corners of the vertex of type 2 that we consider. To complete the construction, we just erase all vertices of type 2 and for each of these we merge its two incident edges into a single edge connecting the two associated vertices of type 1. In this way we get a (non-bipartite in general) planar map  $m$ . Finally we decide that the root edge  $e$  of the map is the first

edge drawn in the construction, oriented in such a way that  $e_+ = \emptyset$ , and we let the distinguished vertex of the map be the vertex  $\rho$ . Note that vertices of the map  $m$  that are different from the distinguished vertex  $\rho$  are exactly the vertices of type 1 in the tree  $\tau$ . In other words, the vertex set  $V(m)$  is identified with the set  $\tau_{(1)} \cup \{\rho\}$ , where  $\tau_{(1)}$  denotes the set of all vertices of  $\tau$  of type 1.

The mapping  $(\tau, (\ell_u)_{u \in \tau_{(1,2)}}) \longrightarrow (m, e, \rho)$  that we have just described is indeed a bijection from  $\mathbb{T}_+$  onto  $\mathcal{M}_{r,p}^+$ . We can construct a similar bijection from  $\mathbb{T}_+$  onto  $\mathcal{M}_{r,p}^-$  by the same construction, with the minor modification that we orient the root edge in such a way that  $e_- = \emptyset$ .

Furthermore we can also adapt the preceding construction in order to get a bijection from  $\mathbb{T}_0$  onto  $\mathcal{M}_{r,p}^0$ . The construction of edges of the map proceeds in the same way, but the root edge is now obtained as the edge resulting of the merging of the two edges incident to  $\emptyset$  (recall that for a tree in  $\mathbb{T}_0$  the root  $\emptyset$  is a vertex of type 2 that has exactly two children, hence also two corners). The orientation of the root edge is chosen according to some convention : For instance, one may decide that the “half-edge” coming from the first corner of  $\emptyset$  corresponds to the origin of the root edge.

In all three cases, distances in the planar map  $m$  satisfy the following key property : For every vertex  $u \in \tau_{(1)}$ , we have

$$d_{\text{gr}}^m(\rho, u) = \ell_u - \min \ell + 1 \tag{3.7}$$

where  $\min \ell$  denotes the minimal label on the tree  $\tau$ . In the left-hand side  $u$  is viewed as a vertex of the map  $m$ , in agreement with the preceding construction.

The three bijections we have described are called the BDG bijections. In the remaining part of this section, we fix a mobile  $(\tau, (\ell_u)_{u \in \tau_{(1,2)}})$  belonging to  $\mathbb{T}_+$  (or to  $\mathbb{T}_0$ ) and its image  $(m, e, \rho)$  under the relevant BDG bijection.

**Remark 3.17.** We could have defined the BDG bijections without distinguishing between types 3 and 4. However, this distinction will be important in the next section when we consider random planar maps and the associated (random) trees. We will see that these random trees are Galton-Watson trees with a different offspring distribution for vertices of type 3 than for vertices of type 4.

If  $u, v \in \tau_{(1,2)}$ , we denote by  $\llbracket u, v \rrbracket$  the set of all vertices of type 1 or 2 that lie on the geodesic path from  $u$  to  $v$  in the tree  $\tau$ .

**Proposition 3.18.** *For every  $u, v \in V(m) \setminus \{\rho\} = \tau_{(1)}$ , and every path  $\gamma = (\gamma(0), \gamma(1), \dots, \gamma(k))$  in  $m$  such that  $\gamma(0) = u$  and  $\gamma(k) = v$ , we have*

$$\min_{0 \leq i \leq k} d_{\text{gr}}^m(\rho, \gamma(i)) \leq \min_{w \in \llbracket u, v \rrbracket} \ell_w - \min \ell + 1.$$

*Démonstration.* We may assume that the path  $\gamma$  does not visit  $\rho$ , since otherwise the result is trivial. Using (3.7), the statement reduces to

$$\min_{0 \leq i \leq k} \ell_{\gamma(i)} \leq \min_{w \in \llbracket u, v \rrbracket} \ell_w.$$

So we fix  $w \in \llbracket u, v \rrbracket$  and we verify that  $\ell_{\gamma(i)} \leq \ell_w$  for some  $i \in \{0, 1, \dots, k\}$ . We may assume that  $w \neq u$  and  $w \neq v$ . The removal of the vertex  $w$  (and of the edges incident to

$w$ ) disconnects the tree  $\tau$  in several connected components. Write  $C$  for the connected component containing  $v$ , and note that this component does not contain  $u$ . Then let  $j \geq 1$  be the first integer such that  $\gamma(j)$  belongs to  $C$ . Thus  $\gamma(j-1) \notin C$ ,  $\gamma(j) \in C$  and the vertices  $\gamma(j-1)$  and  $\gamma(j)$  are linked by an edge of the map  $m$ . From (3.7), we have  $|\ell_{\gamma(j)} - \ell_{\gamma(j-1)}| \leq 1$ . Now we use the fact that the edge between  $\gamma(j-1)$  and  $\gamma(j)$  is produced by the BDG bijection. Suppose first that  $\gamma(j-1)$  and  $\gamma(j)$  have a different label. In that case, noting that the modified contour sequence must visit  $w$  between any visit of  $\gamma(j-1)$  and any visit of  $\gamma(j)$ , we easily get that  $\min\{\ell_{\gamma(j)}, \ell_{\gamma(j-1)}\} \leq \ell_w$  (otherwise our construction could not produce an edge from  $\gamma(j-1)$  to  $\gamma(j)$ ). A similar argument applies to the case when  $\gamma(j-1)$  and  $\gamma(j)$  have the same label. In that case, the edge between  $\gamma(j-1)$  and  $\gamma(j)$  must come from the merging of two edges originating from a vertex of  $\tau$  of type 2. This vertex of type 2 has to belong to the set  $[[\gamma(j-1), \gamma(j)]]$  (which contains  $w$ ), because otherwise the two associated vertices of type 1 could not be  $\gamma(j-1)$  and  $\gamma(j)$ . It again follows from our construction that we must have  $\min\{\ell_{\gamma(j)}, \ell_{\gamma(j-1)}\} \leq \ell_w$ . This completes the proof.  $\square$

In the next corollary, we write  $\mathbf{m}$  for the graph associated with the map  $m$  (in the sense of subsection 3.2.1), which is pointed at the distinguished vertex  $\rho$ . The notation  $d_{\text{Cac}}^{\mathbf{m}}$  then refers to the cactus distance for this pointed graph.

**Corollary 3.19.** *Suppose that the degree of all faces of  $m$  is bounded above by  $D \geq 1$ . Then, for every  $u, v \in V(m) \setminus \{\rho\}$ , we have*

$$\left| d_{\text{Cac}}^{\mathbf{m}}(u, v) - \left( \ell_u + \ell_v - 2 \min_{w \in [[u, v]]} \ell_w \right) \right| \leq 2D + 2.$$

*Démonstration.* From the definition of the cactus distance  $d_{\text{Cac}}^{\mathbf{m}}$  and the preceding proposition, we immediately get the lower bound

$$\begin{aligned} d_{\text{Cac}}^{\mathbf{m}}(u, v) &\geq d_{\text{gr}}^m(\rho, u) + d_{\text{gr}}^m(\rho, v) - 2 \left( \min_{w \in [[u, v]]} \ell_w - \min \ell + 1 \right) \\ &= \ell_u + \ell_v - 2 \min_{w \in [[u, v]]} \ell_w, \end{aligned}$$

by (3.7). In order to get a corresponding upper bound, let  $\eta(0) = u, \eta(1), \dots, \eta(k) = v$  be the vertices of type 1 or 2 belonging to the geodesic path from  $u$  to  $v$  in the tree  $\tau$ , enumerated in their order of appearance on this path. Put  $\tilde{\eta}(i) = \eta(i)$  if  $\eta(i)$  is of type 1, and if  $\eta(i)$  is of type 2, let  $\tilde{\eta}(i)$  be one of the two (possibly equal) vertices of type 1 that are associated with  $\eta(i)$  in the BDG bijection. Then the properties of the BDG bijection ensure that, for every  $i = 0, 1, \dots, k-1$ , the two vertices  $\eta(i)$  and  $\eta(i+1)$  lie on the boundary of the same face of  $m$  (the point is that, in the BDG construction, edges of the map  $m$  are drawn in such a way that they do not cross edges of the tree  $\tau$ ). From our assumption we have thus  $d_{\text{gr}}^m(\tilde{\eta}(i), \tilde{\eta}(i+1)) \leq D$  for every  $i = 0, 1, \dots, k-1$ .

Hence, we can find a path  $\gamma$  in  $m$  starting from  $u$  and ending at  $v$ , such that

$$\begin{aligned} \min_j d_{\text{gr}}^m(\rho, \gamma(j)) &\geq \min_{0 \leq i \leq k} d_{\text{gr}}^m(\rho, \tilde{\eta}(i)) - D \\ &= \min_{0 \leq i \leq k} \ell_{\tilde{\eta}(i)} - \min \ell + 1 - D \\ &\geq \min_{0 \leq i \leq k} \ell_{\eta(i)} - \min \ell - D . \end{aligned}$$

It follows that

$$\begin{aligned} d_{\text{Cac}}^{\mathbf{m}}(u, v) &\leq d_{\text{gr}}^m(\rho, u) + d_{\text{gr}}^m(\rho, v) - 2 \left( \min_{w \in \llbracket u, v \rrbracket} \ell_w - \min \ell - D \right) \\ &= \ell_u + \ell_v - 2 \min_{w \in \llbracket u, v \rrbracket} \ell_w + 2D + 2 . \end{aligned}$$

This completes the proof. □

### 3.4.2 Random planar maps

Following [109] and [114], we now discuss Boltzmann distributions on the space  $\mathcal{M}_{r,p}$ . We consider a sequence  $\mathbf{q} = (q_1, q_2, \dots)$  of non-negative real numbers. We assume that the sequence  $\mathbf{q}$  has finite support ( $q_k = 0$  for all sufficiently large  $k$ ), and is such that  $q_k > 0$  for some  $k \geq 3$ . We will then split our study according to the following two possibilities :

- (A1) There exists an odd integer  $k$  such that  $q_k > 0$ .
- (A2) The sequence  $\mathbf{q}$  is supported on even integers.

If  $m \in \mathcal{M}_{r,p}$ , we define

$$W_{\mathbf{q}}(m) = \prod_{f \in F(m)} q_{\deg(f)}$$

where  $F(m)$  stands for the set of all faces of  $m$  and  $\deg(f)$  is the degree of the face  $f$ . In the case when  $m = \dagger$ , we make the convention that  $q_0 = 1$  and thus  $W_{\mathbf{q}}(\dagger) = 1$ .

By multiplying the sequence  $\mathbf{q}$  by a suitable positive constant, we may assume that this sequence is regular critical in the sense of [114, Definition 1] under assumption (A1) or of [109, Definition 1] under assumption (A2). We refer the reader to the Appendix below for details. In particular, the measure  $W_{\mathbf{q}}$  is then finite, and we can define a probability measure  $P_{\mathbf{q}}$  on  $\mathcal{M}_{r,p}$  by setting

$$P_{\mathbf{q}} = Z_{\mathbf{q}}^{-1} W_{\mathbf{q}},$$

where  $Z_{\mathbf{q}} = W_{\mathbf{q}}(\mathcal{M}_{r,p})$ .

For every integer  $n$  such that  $W_{\mathbf{q}}(\#V(m) = n) > 0$ , we consider a random planar map  $M_n$  distributed according to the conditional measure

$$\frac{P_{\mathbf{q}}(\cdot \cap \{ \#V(m) = n \})}{P_{\mathbf{q}}(\#V(m) = n)} .$$

Throughout the remaining part of Section 3.4, we restrict our attention to values of  $n$  such that  $W_{\mathbf{q}}(\#V(m) = n) > 0$ , so that  $M_n$  is well defined. We write  $\rho_n$  for the distinguished vertex of  $M_n$ .

We now state the main result of this section. In this result,  $\mathbf{M}_n$  stands for the graph (pointed at  $\rho_n$ ) associated with  $M_n$ , as explained at the end of subsection 3.2.1.

**Theorem 3.20.** *There exists a positive constant  $B_{\mathbf{q}}$  such that*

$$B_{\mathbf{q}} n^{-1/4} \cdot \text{Cac}(\mathbf{M}_n) \xrightarrow[n \rightarrow \infty]{(d)} \text{KAC}$$

*in the Gromov-Hausdorff sense.*

The proof of Theorem 3.20 relies on the asymptotic study of the random trees associated with planar maps distributed under Boltzmann distributions via the BDG bijection. The distribution of these random trees was identified in [109] (in the bipartite case) and in [114]. We set

$$Z_{\mathbf{q}}^+ = W_{\mathbf{q}}(\mathcal{M}_{r,p}^+) \geq 1 \quad , \quad Z_{\mathbf{q}}^0 = W_{\mathbf{q}}(\mathcal{M}_{r,p}^0) .$$

Note that, under Assumption (A2),  $W_{\mathbf{q}}$  is supported on bipartite maps and thus  $Z_{\mathbf{q}}^0 = 0$ . We also set

$$P_{\mathbf{q}}^+ = P_{\mathbf{q}}(\cdot \mid \mathcal{M}_{r,p}^+) , \quad P_{\mathbf{q}}^- = P_{\mathbf{q}}(\cdot \mid \mathcal{M}_{r,p}^-) , \quad P_{\mathbf{q}}^0 = P_{\mathbf{q}}(\cdot \mid \mathcal{M}_{r,p}^0) .$$

Note that the definition of  $P_{\mathbf{q}}^0$  only makes sense under Assumption (A1).

The next proposition gives the distribution of the tree associated with a random planar map distributed according to  $P_{\mathbf{q}}^+$ . Before stating this proposition, let us recall that the notion of a four-type Galton-Watson tree is defined analogously to the case of a single type. The distribution of such a random tree is determined by the type of the ancestor, and four offspring distributions  $\nu_i$ ,  $i = 1, 2, 3, 4$ , which are probability distributions on  $\mathbb{Z}_+^4$ ; for every  $i = 1, 2, 3, 4$ ,  $\nu_i$  corresponds to the law of the number of children (having each of the four possible types) of an individual of type  $i$ ; furthermore, given the numbers of children of each type of an individual, these children are ordered in the tree with the same probability for each possible ordering. See [114, Section 2.2.1] for more details, noting that we consider only the case of “uniform ordering” in the terminology of [114].

**Proposition 3.21.** *Suppose that  $M^+$  is a random planar map distributed according to  $P_{\mathbf{q}}^+$ , and let  $(\theta, (\mathcal{L}_u)_{u \in \theta(1,2)})$  be the four-type labeled tree associated with  $M^+$  via the BDG bijection between  $\mathbb{T}_+$  and  $\mathcal{M}_{r,p}^+$ . Then the distribution of  $(\theta, (\mathcal{L}_u)_{u \in \theta(1,2)})$  is characterized by the following properties :*

(i) *The random tree  $\theta$  is a four-type Galton-Watson tree, such that the root  $\emptyset$  has type 1 and the offspring distributions  $\nu_1, \dots, \nu_4$  are determined as follows :*

- $\nu_1$  is supported on  $\{0\} \times \{0\} \times \mathbb{Z}_+ \times \{0\}$ , and for every  $k \geq 0$ ,

$$\nu_1(0, 0, k, 0) = \frac{1}{Z_{\mathbf{q}}^+} \left(1 - \frac{1}{Z_{\mathbf{q}}^+}\right)^k .$$

- $\nu_2(0, 0, 0, 1) = 1$ .

- $\nu_3$  and  $\nu_4$  are supported on  $\mathbb{Z}_+ \times \mathbb{Z}_+ \times \{0\} \times \{0\}$ , and for every integers  $k, k' \geq 0$ ,

$$\nu_3(k, k', 0, 0) = c_{\mathbf{q}} (Z_{\mathbf{q}}^+)^k (Z_{\mathbf{q}}^0)^{k'/2} \binom{2k + k' + 1}{k + 1} \binom{k + k'}{k} q_{2+2k+k'}$$

$$\nu_4(k, k', 0, 0) = c'_{\mathbf{q}} (Z_{\mathbf{q}}^+)^k (Z_{\mathbf{q}}^0)^{k'/2} \binom{2k + k'}{k} \binom{k + k'}{k} q_{1+2k+k'}$$

where  $c_{\mathbf{q}}$  and  $c'_{\mathbf{q}}$  are the appropriate normalizing constants.

- (ii) Conditionally given  $\theta$ ,  $(\mathcal{L}_u)_{u \in \theta_{(1,2)}}$  is uniformly distributed over all admissible labelings.

**Remark 3.22.** The definition of  $\nu_4$  does not make sense under Assumption (A2) (because  $Z_{\mathbf{q}}^0 = 0$  in that case,  $\nu_4(k, k', 0, 0)$  can be nonzero only if  $k' = 0$ , but then  $q_{1+2k+k'} = 0$ ). This is however irrelevant since under Assumption (A2) the property  $Z_{\mathbf{q}}^0 = 0$  entails that  $\nu_3$  is supported on  $\mathbb{Z}_+ \times \{0\} \times \{0\} \times \{0\}$ , and thus the Galton-Watson tree will have no vertices of type 2 or 4.

We refer to [114, Proposition 3] for the proof of Proposition 3.21 under Assumption (A1) and to [109, Proposition 7] for the case of Assumption (A2). In fact, [114] assumes that  $q_k > 0$  for some *odd* integer  $k \geq 3$ , but the results in that paper do cover the situation considered in the present work.

In the next two subsections, we prove Theorem 3.20 under Assumption (A1). The case when Assumption (A2) holds is much easier and will be treated briefly in subsection 3.4.5.

### 3.4.3 The shuffling operation

As already mentioned, we suppose in this section that Assumption (A1) holds. We consider the random four-type labeled tree  $(\theta, (\mathcal{L}_v)_{v \in \theta_{(1,2)}})$  associated with the planar map  $M^+$  via the BDG bijection, as in Proposition 3.21.

Our goal is to investigate the asymptotic behavior, when  $n$  tends to  $\infty$ , of the labeled tree  $(\theta, (\mathcal{L}_v)_{v \in \theta_{(1,2)}})$  conditioned to have  $n - 1$  vertices of type 1 (this corresponds to conditioning  $M^+$  on the event  $\{\#V(M^+) = n\}$ ). As already observed in [114], a difficulty arises from the fact that the label displacements along the tree are not centered, and so the results of [115] cannot be applied immediately. To overcome this difficulty, we will use an idea of [114], which consists in introducing a “shuffled” version of the tree  $\theta$ . In order to explain this, we need to introduce some notation.

Let  $\tau$  be a plane tree and  $u = (i_1, \dots, i_p) \in \tau$ . The tree  $\tau$  shifted at  $u$  is defined by

$$T_u \tau := \{v = (j_1, \dots, j_\ell) : (i_1, \dots, i_p, j_1, \dots, j_\ell) \in \tau\}.$$

Let  $k = k_u(\tau)$  be the number of children of  $u$  in  $\tau$ , and, for every  $1 \leq i \leq k$ , write  $u_{(i)}$  for the  $i$ -th child of  $u$ . The tree  $\tau$  reversed at vertex  $u$  is the new tree  $\tau^*$  characterized by the properties :

- Vertices of  $\tau^*$  which are not descendants of  $u$  are the same as vertices of  $\tau$  which are not descendants of  $u$ .

- $u \in \tau^*$  and  $k_u(\tau^*) = k_u(\tau) = k$ .
- For every  $1 \leq i \leq k$ ,  $T_{u(i)}\tau^* = T_{u(k+1-i)}\tau$ .

Our (random) shuffling operation will consist in reversing the tree  $\tau$  at every vertex of  $\tau$  at an odd generation, with probability  $1/2$  for every such vertex. We now give a more formal description, which will be needed in our applications. We keep on considering a (deterministic) plane tree  $\tau$ . Let  $\mathcal{U}^o$  stand for the set of all  $u \in \mathcal{U}$  such that  $|u|$  is odd. We consider a collection  $(\varepsilon_u)_{u \in \mathcal{U}^o}$  of independent Bernoulli variables with parameter  $1/2$ . We then define a (random) mapping  $\sigma : \tau \rightarrow \mathcal{U}$  by setting, if  $u = (i_1, i_2, \dots, i_p)$ ,

$$\sigma(u) = (j_1, j_2, \dots, j_p)$$

where, for every  $1 \leq \ell \leq p$ ,

- if  $\ell$  is odd,  $j_\ell = i_\ell$ ,
- if  $\ell$  is even,

$$j_\ell = \begin{cases} i_\ell & \text{if } \varepsilon_{(i_1, \dots, i_{\ell-1})} = 0, \\ k_{(i_1, \dots, i_{\ell-1})}(\tau) + 1 - i_\ell & \text{if } \varepsilon_{(i_1, \dots, i_{\ell-1})} = 1. \end{cases}$$

Then  $\tilde{\tau} = \{\sigma(u) : u \in \tau\}$  is a (random) plane tree, called the tree derived from  $\tau$  by the shuffling operation. If  $\tau$  is a four-type tree, we also view  $\tilde{\tau}$  as a four-type tree by assigning to the vertex  $\sigma(u)$  of  $\tilde{\tau}$  the type of the vertex  $u$  in  $\tau$ .

For our purposes it is very important to note that the bijection  $\sigma : \tau \rightarrow \tilde{\tau}$  preserves the genealogical structure, in the sense that  $u$  is an ancestor of  $v$  in  $\tau$  if and only if  $\sigma(u)$  is an ancestor of  $\sigma(v)$  in  $\tilde{\tau}$ . Consequently, if  $u$  and  $v$  are any two vertices of  $\tau_{(1,2)}$ ,  $[[\sigma(u), \sigma(v)]]$  is the image under  $\sigma$  of the set  $[[u, v]]$ .

We can apply this shuffling operation to the random tree  $\theta$  (of course we assume that the collection  $(\varepsilon_u)_{u \in \mathcal{U}^o}$  is independent of  $(\theta, (\mathcal{L}_v)_{v \in \theta_{(1,2)}})$ ). We write  $\tilde{\theta}$  for the four-type tree derived from  $\theta$  by the shuffling operation and we use the same notation  $\sigma$  as above for the “shuffling bijection” from  $\theta$  onto  $\tilde{\theta}$ . We assign labels to the vertices of  $\tilde{\theta}_{(1,2)}$  by putting for every  $u \in \theta_{(1,2)}$ ,

$$\tilde{\mathcal{L}}_{\sigma(u)} = \mathcal{L}_u.$$

Note that the random tree  $\tilde{\theta}$  has the same distribution as  $\theta$ , and is therefore a four-type Galton-Watson tree as described in Proposition 3.21. On the other hand, the labeled trees  $(\theta, (\mathcal{L}_v)_{v \in \theta_{(1,2)}})$  and  $(\tilde{\theta}, (\tilde{\mathcal{L}}_v)_{v \in \tilde{\theta}_{(1,2)}})$  have a different distribution because the admissibility property of labels is not preserved under the shuffling operation. We can still describe the distribution of the labels in the shuffled tree in a simple way. To this end, write  $\text{tp}(u)$  for the type of a vertex  $u$ . Then conditionally on  $\tilde{\theta}$ , for every vertex  $u$  of  $\tilde{\theta}$  such that  $|u|$  is odd, if  $u_{(1)}, \dots, u_{(k)}$  are the children of  $u$  in lexicographical order, and if  $u_{(0)}$  is the parent of  $u$ , the vector of label increments

$$(\tilde{\mathcal{L}}_{u_{(1)}} - \tilde{\mathcal{L}}_{u_{(0)}}, \dots, \tilde{\mathcal{L}}_{u_{(k)}} - \tilde{\mathcal{L}}_{u_{(0)}})$$

is with probability  $1/2$  uniformly distributed over the set

$$\mathbb{A} := \{(i_1, \dots, i_k) \in \mathbb{Z}^k : i_{j+1} \geq i_j - \mathbf{1}_{\{\text{tp}(u_{(j+1)})=1\}}\}, \text{ for all } 0 \leq j \leq k\},$$

and with probability 1/2 uniformly distributed over the set

$$\mathbb{A}' := \{(i_1, \dots, i_k) \in \mathbb{Z}^k : i_j \geq i_{j+1} - \mathbf{1}_{\{\text{tp}(u_{(j)})=1\}}\}, \text{ for all } 0 \leq j \leq k\}.$$

In the definition of both  $\mathbb{A}$  and  $\mathbb{A}'$  we make the convention that  $i_0 = i_{k+1} = 0$  and  $u_{(k+1)} = u_{(0)}$ . Furthermore the vectors of label increments are independent (still conditionally on  $\tilde{\theta}$ ) when  $u$  varies over vertices of  $\tilde{\theta}$  at odd generations.

The preceding description of the distribution of labels in the shuffled tree is easy to establish. Note that the set  $\mathbb{A}$  corresponds to the admissibility property of labels, whereas  $\mathbb{A}'$  corresponds to a “reversed” version of this property.

For every  $u \in \tilde{\theta}_{(1,2)}$ , set

$$\tilde{\mathcal{L}}'_u = \tilde{\mathcal{L}}_u - \frac{1}{2} \mathbf{1}_{\{\text{tp}(u)=2\}}.$$

If we replace  $\tilde{\mathcal{L}}_u$  by  $\tilde{\mathcal{L}}'_u$ , then the vectors of label increments in  $\tilde{\theta}$  become centered. This follows from elementary arguments : See [114, Lemma 2] for a detailed proof. As in [114] or in [119], the fact that the label increments are centered allows us to use the asymptotic results of [115], noting that these results will apply to  $\tilde{\mathcal{L}}_u$  as well as to  $\tilde{\mathcal{L}}'_u$  since the additional term  $\frac{1}{2} \mathbf{1}_{\{\text{tp}(u)=2\}}$  obviously plays no role in the scaling limit. Before we state the relevant result, we need to introduce some notation.

For  $n \geq 2$ , let  $(\tilde{\theta}^n, (\tilde{\mathcal{L}}_v^n)_{v \in \tilde{\theta}^n_{(1,2)}})$  be distributed as the labeled tree  $(\tilde{\theta}, (\tilde{\mathcal{L}}_v)_{v \in \tilde{\theta}_{(1,2)}})$  conditioned on the event  $\{\#\tilde{\theta}_{(1)} = n - 1\}$  (recall that we restrict our attention to values of  $n$  such that the latter event has positive probability). Let  $p_n = \#\tilde{\theta}^n - 1$  and let  $u_0^n = \emptyset, u_1^n, \dots, u_{p_n}^n = \emptyset$  be the modified contour sequence of  $\tilde{\theta}^n$ . The contour process  $C^n = (C_i^n)_{0 \leq i \leq p_n}$  is defined by

$$C_i^n = |u_i^n|$$

and the label process  $V^n = (V_i^n)_{0 \leq i \leq p_n}$  by

$$V_i^n = \tilde{\mathcal{L}}_{u_i^n}.$$

We extend the definition of both processes  $C^n$  and  $V^n$  to the real interval  $[0, p_n]$  by linear interpolation.

Recall the notation  $(\mathbf{e}, Z)$  from Section 3.3.

**Proposition 3.23.** *There exist two positive constants  $A_{\mathbf{q}}$  and  $B_{\mathbf{q}}$  such that*

$$\left( A_{\mathbf{q}} \frac{C^n(p_n s)}{n^{1/2}}, B_{\mathbf{q}} \frac{V^n(p_n s)}{n^{1/4}} \right)_{0 \leq s \leq 1} \xrightarrow[n \rightarrow \infty]{(d)} (\mathbf{e}_s, Z_s)_{0 \leq s \leq 1} \tag{3.8}$$

in the sense of weak convergence of the distributions on the space  $C([0, 1], \mathbb{R}^2)$ .

This follows from the more general results proved in [115] for spatial multitype Galton-Watson trees. One should note that the results of [115] are given for variants of the contour process and the label process (in particular the contour process is replaced by the so-called height process of the tree). However simple arguments show that the convergence in the proposition can be deduced from the ones in [115] : See in particular



Section 1.6 of [97] for a detailed explanation of why convergence results for the height process imply similar results for the contour process. Proposition 3.23 is also equivalent to Theorem 3.1 in [119], where the contour and label processes are defined in a slightly different way.

### 3.4.4 Proof of Theorem 3.20 under Assumption (A1)

We keep assuming that Assumption (A1) holds. Let  $M_n^+$  be distributed according to the probability measure  $P_{\mathbf{q}}^+(\cdot \mid \#V(m) = n)$ , or equivalently as  $M^+$  conditionally on the event  $\{\#V(M^+) = n\}$ . As above,  $\rho_n$  stands for the distinguished point of  $M_n^+$ , and we will write  $\mathbf{M}_n^+$  for the pointed graph associated with  $M_n^+$ . Let  $(\theta^n, (\mathcal{L}_v^n)_{v \in \theta^n_{(1,2)}})$  be the random labeled tree associated with  $M_n^+$  via the BDG bijection between  $\mathbb{T}_+$  and  $\mathcal{M}_{r,p}^+$ . Notice that  $(\theta^n, (\mathcal{L}_v^n)_{v \in \theta^n_{(1,2)}})$  has the same distribution as  $(\theta, (\mathcal{L}_v)_{v \in \theta_{(1,2)}})$  conditional on  $\{\#\theta_{(1)} = n - 1\}$ .

We write  $(\tilde{\theta}^n, (\tilde{\mathcal{L}}_v^n)_{v \in \tilde{\theta}^n_{(1,2)}})$  for the tree derived from  $(\theta^n, (\mathcal{L}_v^n)_{v \in \theta^n_{(1,2)}})$  by the shuffling operation, and  $\sigma_n$  for the shuffling bijection from  $\theta^n$  onto  $\tilde{\theta}^n$ . The notation  $(\tilde{\theta}^n, (\tilde{\mathcal{L}}_v^n)_{v \in \tilde{\theta}^n_{(1,2)}})$  is consistent with the end of the preceding subsection, since conditioning the tree on having  $n - 1$  vertices of type 1 clearly commutes with the shuffling operation.

As previously,  $u_0^n = \emptyset, u_1^n, \dots, u_{p_n}^n$  denotes the modified contour sequence of  $\tilde{\theta}^n$ . For every  $j \in \{0, 1, \dots, p_n\}$ , we put  $v_j^n = \sigma_n^{-1}(u_j^n)$ . Recall that by construction the type of  $u_j^n$  (in  $\tilde{\theta}^n$ ) coincides with the type of  $v_j^n$  (in  $\theta^n$ ).

Using the Skorokhod representation theorem, we may assume that the convergence (3.8) holds almost surely. We will then prove that the convergence

$$B_{\mathbf{q}} n^{-1/4} \cdot \text{Cac}(\mathbf{M}_n^+) \xrightarrow[n \rightarrow \infty]{} \text{KAC} \quad (3.9)$$

also holds almost surely, in the Gromov-Hausdorff sense.

We first define a correspondence  $\mathcal{R}_n^0$  between  $\mathcal{T}_{\mathbf{e}}$  and  $V(M_n^+)$  by declaring that  $(a_*, \rho_n)$  belongs to  $\mathcal{R}_n^0$ , and, for every  $s \in [0, 1]$ :

- if  $v_{[p_n s]}^n$  is of type 1,  $(p_{\mathbf{e}}(s), v_{[p_n s]}^n)$  belongs to  $\mathcal{R}_n^0$ ;
- if  $v_{[p_n s]}^n$  is of type 2, then if  $w$  is any of the two (possibly equal) vertices of type 1 associated with  $v_{[p_n s]}^n$ ,  $(p_{\mathbf{e}}(s), w)$  belongs to  $\mathcal{R}_n^0$ .

We then write  $\mathcal{R}_n$  for the induced correspondence between the quotient spaces  $\text{KAC} = \mathcal{T}_{\mathbf{e}} / \simeq$  and  $\text{Cac}(\mathbf{M}_n^+)$ . A pair  $(x, \alpha) \in \text{KAC} \times \text{Cac}(\mathbf{M}_n^+)$  belongs to  $\mathcal{R}_n$  if and only if there exists a representative  $a$  of  $x$  in  $\mathcal{T}_{\mathbf{e}}$  and a representative  $u$  of  $\alpha$  in  $V(M_n^+)$  such that  $(a, u) \in \mathcal{R}_n^0$ .

Thanks to (3.3), the convergence (3.9) will be proved if we can verify that the distortion of  $\mathcal{R}_n$ , when KAC is equipped with the distance  $d_{\text{KAC}}$  and  $\text{Cac}(\mathbf{M}_n^+)$  is equipped with  $B_{\mathbf{q}} n^{-1/4} d_{\text{Cac}}^{\mathbf{M}_n^+}$ , tends to 0 as  $n \rightarrow \infty$ , almost surely. To this end, it is enough to verify that

$$\lim_{n \rightarrow \infty} \sup_{0 \leq s \leq 1} \left| d_{\text{KAC}}(a_*, p_{\mathbf{e}}(s)) - B_{\mathbf{q}} n^{-1/4} d_{\text{Cac}}^{\mathbf{M}_n^+}(\rho_n, \hat{v}_{[p_n s]}^n) \right| = 0, \quad \text{a.s.} \quad (3.10)$$

and

$$\lim_{n \rightarrow \infty} \sup_{s, t \in [0, 1]} \left| d_{\text{KAC}}(p_{\mathbf{e}}(s), p_{\mathbf{e}}(t)) - B_{\mathbf{q}} n^{-1/4} d_{\text{Cac}}^{\mathbf{M}_n^+}(\widehat{v}_{[p_n s]}^n, \widehat{v}_{[p_n t]}^n) \right| = 0, \quad \text{a.s.} \quad (3.11)$$

In both (3.10) and (3.11),  $\widehat{v}_{[p_n s]}^n = v_{[p_n s]}^n$  if  $v_{[p_n s]}^n$  is of type 1, whereas, if  $v_{[p_n s]}^n$  is of type 2,  $\widehat{v}_{[p_n s]}^n$  stands for one of the vertices of type 1 associated with  $v_{[p_n s]}^n$  (obviously the validity of (3.10) and (3.11) does not depend on the choice of this vertex).

The proof of (3.10) is easy. Note that

$$d_{\text{KAC}}(a_*, p_{\mathbf{e}}(s)) = Z_{p_{\mathbf{e}}(s)} - Z_{a_*} = Z_s - \underline{Z}$$

and, by (3.7),

$$d_{\text{Cac}}^{\mathbf{M}_n^+}(\rho_n, \widehat{v}_{[p_n s]}^n) = d_{\text{gr}}^{\mathbf{M}_n^+}(\rho_n, \widehat{v}_{[p_n s]}^n) = \mathcal{L}_{\widehat{v}_{[p_n s]}^n}^n - \min \mathcal{L}^n + 1$$

so that

$$\left| d_{\text{Cac}}^{\mathbf{M}_n^+}(\rho_n, \widehat{v}_{[p_n s]}^n) - (\mathcal{L}_{v_{[p_n s]}^n}^n - \min \mathcal{L}^n) \right| \leq 1.$$

Since  $\mathcal{L}_{v_{[p_n s]}^n}^n - \min \mathcal{L}^n = \tilde{\mathcal{L}}_{u_{[p_n s]}^n}^n - \min \tilde{\mathcal{L}}^n = V_{[p_n s]}^n - \min V^n$ , our claim (3.10) follows from the (almost sure) convergence (3.8).

It remains to establish (3.11). It suffices to prove that almost surely, for every choice of the sequences  $(s_n)$  and  $(t_n)$  in  $[0, 1]$ , we have

$$\lim_{n \rightarrow \infty} \left| d_{\text{KAC}}(p_{\mathbf{e}}(s_n), p_{\mathbf{e}}(t_n)) - B_{\mathbf{q}} n^{-1/4} d_{\text{Cac}}^{\mathbf{M}_n^+}(\widehat{v}_{[p_n s_n]}^n, \widehat{v}_{[p_n t_n]}^n) \right| = 0.$$

We will prove that the preceding convergence holds for all choices of the sequences  $(s_n)$  and  $(t_n)$ , on the set of full probability measure where the convergence (3.8) holds. From now on we argue on the latter set.

By a compactness argument, we may assume that the sequences  $(s_n)$  and  $(t_n)$  converge to  $s$  and  $t$  respectively as  $n \rightarrow \infty$ . The proof then reduces to checking that

$$\lim_{n \rightarrow \infty} B_{\mathbf{q}} n^{-1/4} d_{\text{Cac}}^{\mathbf{M}_n^+}(\widehat{v}_{[p_n s_n]}^n, \widehat{v}_{[p_n t_n]}^n) = d_{\text{KAC}}(p_{\mathbf{e}}(s), p_{\mathbf{e}}(t)) = Z_s + Z_t - 2 \min_{c \in \llbracket p_{\mathbf{e}}(s), p_{\mathbf{e}}(t) \rrbracket} Z_c.$$

From Corollary 3.19 (and the fact that the sequence  $\mathbf{q}$  is finitely supported), this will follow if we can verify that

$$\lim_{n \rightarrow \infty} B_{\mathbf{q}} n^{-1/4} \left( \mathcal{L}_{\widehat{v}_{[p_n s_n]}^n}^n + \mathcal{L}_{\widehat{v}_{[p_n t_n]}^n}^n - 2 \min_{w \in \llbracket \widehat{v}_{[p_n s_n]}^n, \widehat{v}_{[p_n t_n]}^n \rrbracket} \mathcal{L}_w^n \right) = Z_s + Z_t - 2 \min_{c \in \llbracket p_{\mathbf{e}}(s), p_{\mathbf{e}}(t) \rrbracket} Z_c.$$

Observe that

$$\left| \mathcal{L}_{\widehat{v}_{[p_n s_n]}^n}^n - \mathcal{L}_{v_{[p_n s_n]}^n}^n \right| \leq 1$$

and  $\mathcal{L}_{v_{[p_n s_n]}^n}^n = \tilde{\mathcal{L}}_{u_{[p_n s_n]}^n}^n$ . From the convergence (3.8), we have

$$\lim_{n \rightarrow \infty} B_{\mathbf{q}} n^{-1/4} \mathcal{L}_{\widehat{v}_{[p_n s_n]}^n}^n = \lim_{n \rightarrow \infty} B_{\mathbf{q}} n^{-1/4} \tilde{\mathcal{L}}_{u_{[p_n s_n]}^n}^n = \lim_{n \rightarrow \infty} B_{\mathbf{q}} n^{-1/4} V_{[p_n s_n]}^n = Z_s$$

and similarly if the sequence  $(s_n)$  is replaced by  $(t_n)$ . Finally, we need to verify that

$$\lim_{n \rightarrow \infty} \left( B_{\mathbf{q}} n^{-1/4} \min_{w \in \llbracket \widehat{v}_{[p_n s_n]}^n, \widehat{v}_{[p_n t_n]}^n \rrbracket} \mathcal{L}_w^n \right) = \min_{c \in \llbracket p_{\mathbf{e}}(s), p_{\mathbf{e}}(t) \rrbracket} Z_c. \quad (3.12)$$

In proving (3.12), we may replace  $\widehat{v}_{[p_n s_n]}^n$  and  $\widehat{v}_{[p_n t_n]}^n$  by  $v_{[p_n s_n]}^n$ , and  $v_{[p_n t_n]}^n$  respectively. The point is that if  $u$  is a vertex of  $\theta^n$  of type 2 and  $v$  is an associated vertex of type 1, our definitions imply that  $\min_{w \in \llbracket u, v \rrbracket} \mathcal{L}_w^n = \mathcal{L}_v^n$ . Without loss of generality we can also assume that  $s \leq t$ .

Since  $\llbracket u_{[p_n s_n]}^n, u_{[p_n t_n]}^n \rrbracket$  is the image under  $\sigma_n$  of  $\llbracket v_{[p_n s_n]}^n, v_{[p_n t_n]}^n \rrbracket$ , (3.12) will hold if we can prove that

$$\lim_{n \rightarrow \infty} \left( B_{\mathbf{q}} n^{-1/4} \min_{w \in \llbracket u_{[p_n s_n]}^n, u_{[p_n t_n]}^n \rrbracket} \tilde{\mathcal{L}}_w^n \right) = \min_{c \in \llbracket p_{\mathbf{e}}(s), p_{\mathbf{e}}(t) \rrbracket} Z_c. \quad (3.13)$$

Let us first prove the upper bound

$$\limsup_{n \rightarrow \infty} \left( B_{\mathbf{q}} n^{-1/4} \min_{w \in \llbracket u_{[p_n s_n]}^n, u_{[p_n t_n]}^n \rrbracket} \tilde{\mathcal{L}}_w^n \right) \leq \min_{c \in \llbracket p_{\mathbf{e}}(s), p_{\mathbf{e}}(t) \rrbracket} Z_c. \quad (3.14)$$

Let us pick  $c \in \llbracket p_{\mathbf{e}}(s), p_{\mathbf{e}}(t) \rrbracket$ . We may assume that  $c \neq p_{\mathbf{e}}(s)$  and  $c \neq p_{\mathbf{e}}(t)$  (otherwise the desired lower bound immediately follows from the convergence (3.8)). Then, we can find  $r \in (s, t)$  such that  $c = p_{\mathbf{e}}(r)$  and either

$$\mathbf{e}_u > \mathbf{e}_r, \quad \text{for every } u \in [s, r)$$

or

$$\mathbf{e}_u > \mathbf{e}_r, \quad \text{for every } u \in (r, t].$$

Consider only the first case, since the second one can be treated in a similar manner. The convergence of the rescaled contour processes then guarantees that we can find a sequence  $(k_n)$  of positive integers such that  $k_n/p_n \rightarrow r$  as  $n \rightarrow \infty$ , and

$$C_k^n > C_{k_n}^n, \quad \text{for every } k \in \{[p_n s_n], [p_n s_n] + 1, \dots, k_n - 1\}$$

for all sufficiently large  $n$ . The latter property, and the construction of the contour sequence of the tree  $\theta^n$ , ensure that  $u_{k_n}^n \in \llbracket u_{[p_n s_n]}^n, u_{[p_n t_n]}^n \rrbracket$ , for all sufficiently large  $n$ . However, by the convergence of the rescaled label processes, we have

$$\lim_{n \rightarrow \infty} B_{\mathbf{q}} n^{-1/4} \tilde{\mathcal{L}}_{u_{k_n}^n}^n = Z_r = Z_c.$$

Consequently,

$$\limsup_{n \rightarrow \infty} \left( B_{\mathbf{q}} n^{-1/4} \min_{w \in \llbracket u_{[p_n s_n]}^n, u_{[p_n t_n]}^n \rrbracket} \tilde{\mathcal{L}}_w^n \right) \leq Z_c$$

and since this holds for every choice of  $c$  the upper bound (3.14) follows.

Let us turn to the lower bound

$$\liminf_{n \rightarrow \infty} \left( B_{\mathbf{q}} n^{-1/4} \min_{w \in \llbracket u_{[p_n s_n]}^n, u_{[p_n t_n]}^n \rrbracket} \tilde{\mathcal{L}}_w^n \right) \geq \min_{c \in \llbracket p_{\mathbf{e}}(s), p_{\mathbf{e}}(t) \rrbracket} Z_c. \quad (3.15)$$

For every  $n$ , let  $w_n \in \llbracket u_{[p_n s_n]}^n, u_{[p_n t_n]}^n \rrbracket$  be such that

$$\min_{w \in \llbracket u_{[p_n s_n]}^n, u_{[p_n t_n]}^n \rrbracket} \tilde{\mathcal{L}}_w^n = \tilde{\mathcal{L}}_{w_n}^n.$$

We can write  $w_n = u_{j_n}^n$  where  $j_n \in \{[p_n s_n], [p_n s_n] + 1, \dots, [p_n t_n]\}$  is such that

$$C_{j_n}^m = \min_{[p_n s_n] \leq j \leq j_n} C_j^m, \quad (3.16)$$

or

$$C_{j_n}^n = \min_{j_n \leq j \leq [p_n t_n]} C_j^m. \quad (3.17)$$

We need to verify that

$$\liminf_{n \rightarrow \infty} B_{\mathbf{q}} n^{-1/4} \tilde{\mathcal{L}}_{w_n}^n \geq \min_{c \in \llbracket p_{\mathbf{e}}(s), p_{\mathbf{e}}(t) \rrbracket} Z_c.$$

We argue by contradiction and suppose that there exist  $\varepsilon > 0$  and a subsequence  $(n_k)$  such that, for every  $k$ ,

$$B_{\mathbf{q}} n_k^{-1/4} \tilde{\mathcal{L}}_{w_{n_k}}^{n_k} \leq \min_{c \in \llbracket p_{\mathbf{e}}(s), p_{\mathbf{e}}(t) \rrbracket} Z_c - \varepsilon.$$

By extracting another subsequence if necessary, we may assume furthermore that  $j_{n_k}/p_{n_k} \rightarrow r \in [s, t]$  as  $k \rightarrow \infty$ , and that (3.16) holds with  $n = n_k$  for every  $k$  (the case when (3.17) holds instead of (3.16) is treated in a similar manner). Then, from the convergence of rescaled contour processes, we have

$$\mathbf{e}_r = \min_{s \leq u \leq r} \mathbf{e}_r,$$

which implies that  $p_{\mathbf{e}}(r) \in \llbracket p_{\mathbf{e}}(s), p_{\mathbf{e}}(t) \rrbracket$ . Furthermore, from the convergence of rescaled label processes,

$$Z_{p_{\mathbf{e}}(r)} = Z_r = \lim_{k \rightarrow \infty} B_{\mathbf{q}} n_k^{-1/4} \tilde{\mathcal{L}}_{w_{n_k}}^{n_k} \leq \min_{c \in \llbracket p_{\mathbf{e}}(s), p_{\mathbf{e}}(t) \rrbracket} Z_c - \varepsilon.$$

This contradiction completes the proof of (3.15) and of the convergence (3.9).

In order to complete the proof of Theorem 3.20 under Assumption (A1), it suffices to verify that the convergence (3.9) also holds (in distribution) if  $M_n^+$  is replaced by a random planar map  $M_n^-$  distributed according to  $P_{\mathbf{q}}^-(\cdot \mid \#V(m) = n)$ , or by a random planar map  $M_n^0$  distributed according to  $P_{\mathbf{q}}^0(\cdot \mid \#V(m) = n)$ . The first case is trivial since  $M_n^-$  can be obtained from  $M_n^+$  simply by reversing the orientation of the root edge. The case of  $M_n^0$  is treated by a similar method as the one we used for  $M_n^+$ . We first need an analogue of Proposition 3.21, which is provided by the last statement of Proposition 3 in [114]. In this analogue, the random labeled tree associated with a planar map distributed according to  $P_{\mathbf{q}}^0$  is described as the concatenation (at the root vertex) of two independent labeled Galton-Watson trees whose root is of type 2, with the same offspring distributions as in Proposition 3.21. The results of [115] can be used to verify that Proposition 3.23 still holds with the same constants  $A_{\mathbf{q}}$  and  $B_{\mathbf{q}}$ , and the remaining part of the argument goes through without change. This completes the proof of Theorem 3.20 under Assumption (A1).

### 3.4.5 The bipartite case

In this section, we briefly discuss the proof of Theorem 3.20 under Assumption (A2). In that case, since  $W_{\mathbf{q}}(\mathcal{M}_{r,p}^0) = 0$ , it is obviously enough to prove the convergence of Theorem 3.20 with  $M_n$  replaced by  $M_n^+$ . The proof becomes much simpler because we do not need the shuffling operation. As previously, we introduce the labeled tree  $(\theta^n, (\mathcal{L}_v^n)_{v \in \theta^n_{(1,2)}})$  associated with  $M_n^+$  via the BDG bijection, but we now define  $u_0^n = \emptyset, u_1^n, \dots, u_{p_n}^n = \emptyset$  as the modified contour sequence of  $\theta_n$  (instead of  $\tilde{\theta}_n$ ). We then define the contour process  $C_i^n = |u_i^n|$  and the label process  $V_i^n = \mathcal{L}_{u_i^n}^n$ , for  $0 \leq i \leq p_n$ . Proposition 3.7 then holds in exactly the same form, as a consequence of the results of [109]. The reason why we do not need the shuffling operation is the fact that the label increments of  $(\theta^n, (\mathcal{L}_v^n)_{v \in \theta^n_{(1,2)}})$  are centered in the bipartite case.

Once the convergence (3.8) is known to hold, it suffices to repeat all steps of the proof in subsection 3.4.4, replacing  $\tilde{\theta}^n$  by  $\theta^n$  and  $v_i^n$  by  $u_i^n$  wherever this is needed. We leave the details to the reader.

## 3.5 The dimension of the Brownian cactus

In this section, we compute the Hausdorff dimension of the Brownian cactus KAC. We write  $\mathbf{p} : \mathcal{T}_{\mathbf{e}} \rightarrow \text{KAC} = \mathcal{T}_{\mathbf{e}} / \asymp$  for the canonical projection. The uniform measure  $\mu$  on KAC is the image of the mass measure Vol on the CRT (see Section 3.3) under  $\mathbf{p}$ . For every  $x$  in KAC and every  $\delta \geq 0$ , we denote the closed ball of center  $x$  and radius  $\delta$  in KAC by  $B_{\text{KAC}}(x, \delta)$ . The following theorem gives information about the  $\mu$ -measure of these balls around a typical point of KAC.

**Proposition 3.24.** (i) *We have*

$$\mathbb{E} \left[ \int \mu(dx) \mu(B_{\text{KAC}}(x, \delta)) \right] = \frac{2^{5/4} \Gamma(1/4)}{3\sqrt{\pi}} \delta^3 + o(\delta^3),$$

as  $\delta \rightarrow 0$ .

(ii) *For every  $\varepsilon > 0$ ,*

$$\limsup_{\delta \rightarrow 0} \frac{\mu(B_{\text{KAC}}(x, \delta))}{\delta^{4-\varepsilon}} = 0, \quad \mu(dx) \text{ a.e., a.s.}$$

**Remark 3.25.** Let  $U$  be uniformly distributed over  $[0, 1]$ , so that  $p_{\mathbf{e}}(U)$  is distributed according to Vol and  $X = \mathbf{p} \circ p_{\mathbf{e}}(U)$  is distributed according to  $\mu$ . Assertion (i) of the theorem says that the mean volume of the ball  $B_{\text{KAC}}(X, \delta)$  is of order  $\delta^3$ , whereas assertion (ii) shows that almost surely the volume of this ball will be bounded above by  $\delta^{4-\varepsilon}$  when  $\delta$  is small. This difference between the mean and the almost sure behavior is specific to the Brownian cactus. In the case of the Brownian map, results from Section 6 of [99] show that  $\delta^4$  is the correct order both for the mean and the almost sure behavior of the volume of a typical ball of radius  $\delta$ .

In relation with this, we see that in contrast with the CRT or the Brownian map, the Brownian cactus is not invariant under re-rooting according to the “uniform” measure  $\mu$ . This means that KAC re-rooted at  $X$  does not have the same distribution as KAC.

Indeed, since  $d_{\text{Kac}}^{\mathbf{E}}(\rho, x) = d(\rho, x)$  for every pointed geodesic space  $\mathbf{E} = (E, d, \rho)$ , the previous considerations, and Proposition 3.14, entail that  $\mu(B_{\text{KAC}}(\rho, \delta))$  is of order  $\delta^4$  both in the mean and in the a.s. sense.

*Démonstration.* (i) Fix  $\delta > 0$ . Let  $U$  and  $U'$  be two independent random variables that are uniformly distributed over  $[0, 1]$  and independent of  $(\mathbf{e}, Z)$ . By the very definition of  $\mu$ , we have

$$\mathbb{E} \left[ \int \mu(dx) \mu(B_{\text{KAC}}(x, \delta)) \right] = \mathbb{P} [d_{\text{KAC}}(p_{\mathbf{e}}(U), p_{\mathbf{e}}(U')) \leq \delta].$$

The value of  $d_{\text{KAC}}(p_{\mathbf{e}}(U), p_{\mathbf{e}}(U'))$  is determined by the labels  $Z_a$  for  $a \in \llbracket p_{\mathbf{e}}(U), p_{\mathbf{e}}(U') \rrbracket$ . Write  $(g_{U,U'}(t), 0 \leq t \leq d_{\mathbf{e}}(U, U'))$  for the geodesic path from  $p_{\mathbf{e}}(U)$  to  $p_{\mathbf{e}}(U')$  in the tree  $\mathcal{T}_{\mathbf{e}}$  (so that  $\llbracket p_{\mathbf{e}}(U), p_{\mathbf{e}}(U') \rrbracket$  is the range of  $g_{U,U'}$ ). Then, conditionally on the triplet  $(\mathbf{e}, U, U')$  the process

$$\left( Z_{g_{U,U'}(t)} - Z_{p_{\mathbf{e}}(U)} \right)_{0 \leq t \leq d_{\mathbf{e}}(U, U')},$$

is a standard linear Brownian motion. Hence if  $(B_t)_{t \geq 0}$  is a linear Brownian motion independent of  $(\mathbf{e}, U, U')$ , we have

$$\mathbb{P} [d_{\text{KAC}}(p_{\mathbf{e}}(U), p_{\mathbf{e}}(U')) \leq \delta] = \mathbb{P} \left[ B_L - 2 \min_{0 \leq s \leq L} B_s \leq \delta \right],$$

where  $L = d_{\mathbf{e}}(U, U')$ . Pitman’s theorem [123, Theorem VI.3.5] implies that, for every fixed  $l \geq 0$ ,  $B_l - 2 \min_{0 \leq s \leq l} B_s$  has the same distribution as  $B_l^{(3)}$ , where  $(B_t^{(3)})_{t \geq 0}$  denotes a three-dimensional Bessel process started from 0. From the invariance under uniform re-rooting of the distribution of the CRT (see for example [103]), the variable  $d_{\mathbf{e}}(U, U')$  has the same distribution as  $d_{\mathbf{e}}(0, U) = \mathbf{e}_U$ , which has density  $4l e^{-2l^2}$ . Consequently, we can explicitly compute

$$\begin{aligned} \mathbb{P} [d_{\text{KAC}}(U, U') \leq \delta] &= 4 \int_0^\infty dl l e^{-2l^2} \mathbb{P} [B_l^{(3)} \leq \delta], \\ &= 4 \int_0^\infty dl l e^{-2l^2} \int_{\mathbb{R}^3} dz (2\pi l)^{-3/2} e^{-|z|^2/2l} \mathbf{1}_{\{|z| \leq \delta\}}, \\ &= 4 \sqrt{\frac{2}{\pi}} \int_0^\infty dl l^{-1/2} e^{-2l^2} \int_0^\delta du u^2 e^{-u^2/2l}, \\ &= 4 \sqrt{\frac{2}{\pi}} \int_0^\delta du u^2 \int_0^\infty dl l^{-1/2} \exp(-2l^2 - (u^2/2l)). \end{aligned}$$

The desired result follows since

$$\lim_{u \rightarrow 0} \int_0^\infty dl l^{-1/2} \exp(-2l^2 - (u^2/2l)) = \int_0^\infty dl l^{-1/2} \exp(-2l^2) = 2^{-5/4} \Gamma(1/4).$$

(ii) Let us fix  $r \in ]0, 1[$ . For every  $u \in [0, \mathbf{e}_r]$ , set

$$\begin{aligned} G_{\mathbf{e}}(r, u) &= \max\{s \in [0, r] : \mathbf{e}_s = \mathbf{e}_r - u\}, \\ D_{\mathbf{e}}(r, u) &= \min\{s \in [r, 1] : \mathbf{e}_s = \mathbf{e}_r - u\}. \end{aligned}$$

Then  $p_{\mathbf{e}}(G_{\mathbf{e}}(r, u)) = p_{\mathbf{e}}(D_{\mathbf{e}}(r, u))$  is a point of  $[[p_{\mathbf{e}}(0), p_{\mathbf{e}}(r)]]$ , and more precisely the path  $u \rightarrow p_{\mathbf{e}}(G_{\mathbf{e}}(r, u))$ ,  $0 \leq u \leq \mathbf{e}_r$  is the geodesic from  $p_{\mathbf{e}}(r)$  to  $p_{\mathbf{e}}(0)$  in the tree  $\mathcal{T}_{\mathbf{e}}$ . As a consequence, conditionally on  $\mathbf{e}$ , the process

$$M_u^{(r)} := Z_r - \min\{Z_v : v \in [[p_{\mathbf{e}}(G_{\mathbf{e}}(r, u)), p_{\mathbf{e}}(r)]]\}, \quad 0 \leq u \leq \mathbf{e}_r$$

has the same distribution as

$$- \min_{0 \leq v \leq u} B_v, \quad 0 \leq u \leq \mathbf{e}_r$$

where  $B$  is as above. By classical results (see e.g. Theorem 6.2 in [79]), we have, for every  $\varepsilon \in ]0, 1/2[$ ,

$$\lim_{u \rightarrow 0} u^{-1/2-\varepsilon} M_u^{(r)} = \infty, \quad \text{a.s.} \tag{3.18}$$

On the other hand, if  $t \in [0, 1] \setminus G_{\mathbf{e}}(r, u), D_{\mathbf{e}}(r, u)[$ , we have  $\min_{t \wedge r \leq s \leq t \vee r} \mathbf{e}_s \leq \mathbf{e}_r - u$ , which implies that the segment  $[[p_{\mathbf{e}}(t), p_{\mathbf{e}}(r)]]$  contains  $[[p_{\mathbf{e}}(G_{\mathbf{e}}(r, u)), p_{\mathbf{e}}(r)]]$ , and therefore

$$d_{\text{KAC}}(p_{\mathbf{e}}(t), p_{\mathbf{e}}(r)) \geq M_u^{(r)}.$$

Using (3.18), it follows that, for every fixed  $\varepsilon \in ]0, 1/2[$ , we have a.s. for all  $u > 0$  small enough

$$B_{\text{KAC}}(p_{\mathbf{e}}(r), u^{1/2+\varepsilon}) \subset \left( \text{KAC} \setminus \mathfrak{p} \circ p_{\mathbf{e}}([0, G_{\mathbf{e}}(r, u)] \cup [D_{\mathbf{e}}(r, u), 1]) \right),$$

and in particular

$$\mu(B_{\text{KAC}}(p_{\mathbf{e}}(r), u^{1/2+\varepsilon})) \leq D_{\mathbf{e}}(r, u) - G_{\mathbf{e}}(r, u).$$

However, the same standard results about Brownian motion that we already used to derive (3.18) imply that

$$\lim_{u \rightarrow 0} u^{-2+\varepsilon} (D_{\mathbf{e}}(r, u) - G_{\mathbf{e}}(r, u)) = 0, \quad \text{a.s.}$$

We conclude that, for every  $\varepsilon \in ]0, 1/2[$ ,

$$\lim_{u \rightarrow 0} u^{-2+\varepsilon} \mu(B_{\text{KAC}}(p_{\mathbf{e}}(r), u^{1/2+\varepsilon})) = 0, \quad \text{a.s.}$$

and property (ii) follows, in fact in a slightly stronger form than stated in the theorem.  $\square$

**Corollary 3.26.** *Almost surely, the Hausdorff dimension of KAC is 4.*

*Démonstration.* Classical density theorems for Hausdorff measures show that the existence of a non-trivial measure  $\mu$  satisfying the property stated in part (ii) of Proposition 3.24 implies the lower bound  $\dim(\text{KAC}) \geq 4$ . To get the corresponding upper bound, we first note that the mapping  $[0, 1] \ni t \rightarrow Z_t$  is a.s. Hölder continuous with exponent  $1/4 - \varepsilon$ , for any  $\varepsilon \in ]0, 1/4[$ . Observing that  $[[p_{\mathbf{e}}(t), p_{\mathbf{e}}(t')]] \subset p_{\mathbf{e}}([t \wedge t', t \vee t'])$ , for every  $t, t' \in [0, 1]$ , it readily follows that the composition  $\mathfrak{p} \circ p_{\mathbf{e}}$  defined on  $[0, 1]$  and with values in KAC, is a.s. Hölder continuous with exponent  $1/4 - \varepsilon$ , for any  $\varepsilon \in ]0, 1/4[$ . Hence, the Hausdorff dimension of KAC, which is the range of  $\mathfrak{p} \circ p_{\mathbf{e}}$ , must be bounded above by 4.  $\square$

### 3.6 Separating cycles

In this section, we study the existence and properties of a cycle with minimal length separating two points of the Brownian map, under the condition that this cycle contains a third point. This is really a problem about the Brownian map, but the cactus distance plays an important role in the statement. Our results in this section are related to the work of Bouttier and Guitter [34] for large random quadrangulations of the plane.

We consider the Brownian map as the random pointed compact metric space  $(m_\infty, D, \rho_*)$  that appears in the convergence (3.5) for a suitable choice of the sequence  $(n_k)$ . Recall that the metric  $D$  may depend on the choice of the sequence, but the subsequent results will hold for any of the possible limiting metrics. We set  $\mathbf{p} = \Pi \circ p_e$ , which corresponds to the canonical projection from  $[0, 1]$  onto  $m_\infty$ . If  $U$  is uniformly distributed over  $[0, 1]$ , the point  $\mathbf{p}(U)$  is distributed according to the volume measure  $\lambda$  on  $m_\infty$ .

A loop in  $m_\infty$  is a continuous path  $\gamma : [0, T] \rightarrow m_\infty$ , where  $T > 0$ , such that  $\gamma(0) = \gamma(T)$ . If  $x$  and  $y$  are two distinct points of  $m_\infty$ , we say that the loop  $\gamma$  separates the points  $x$  and  $y$  if  $x$  and  $y$  lie in distinct connected components of  $m_\infty \setminus \{\gamma(t) : 0 \leq t \leq T\}$ . It is known [102] that  $(m_\infty, D)$  is homeomorphic to the 2-sphere, so that separating loops do exist. We denote by  $S(x, y, \rho_*)$  the set of all loops  $\gamma$  such that  $\gamma(0) = \rho_*$  and  $\gamma$  separates  $x$  and  $y$ . Recall from subsection 3.2.2 the definition of the length of a curve in a metric space.

**Theorem 3.27.** *Let  $U_1$  and  $U_2$  be independent and uniformly distributed over  $[0, 1]$ . Then almost surely there exists a unique loop  $\gamma_* \in S(\mathbf{p}(U_1), \mathbf{p}(U_2), \rho_*)$  with minimal length, up to reparametrization and time-reversal. This loop is obtained as the concatenation of the two distinct geodesic paths from  $\Pi(\beta)$  to  $\rho_*$ , where  $\beta$  is the a.s. unique point of  $\llbracket p_e(U_1), p_e(U_2) \rrbracket$  such that*

$$Z_\beta = \min_{a \in \llbracket p_e(U_1), p_e(U_2) \rrbracket} Z_a.$$

In particular, the length of  $\gamma_*$  is

$$L(\gamma_*) = 2D(\rho_*, \Pi(\beta)) = D(\rho_*, \mathbf{p}(U_1)) + D(\rho_*, \mathbf{p}(U_2)) - 2 d_{\text{KAC}}(p_e(U_1), p_e(U_2)).$$

The complement in  $m_\infty$  of the range of  $\gamma_*$  has exactly two components  $C_1$  and  $C_2$ , such that  $\mathbf{p}(U_1) \in C_1$  and  $\mathbf{p}(U_2) \in C_2$ , and the pair  $(\lambda(C_1), \lambda(C_2))$  is distributed according to the beta distribution with parameters  $(\frac{1}{4}, \frac{1}{4})$  :

$$\mathbb{E} [f(\lambda(C_1), \lambda(C_2))] = \frac{\Gamma(1/2)}{\Gamma(1/4)^2} \int_0^1 dt (t(1-t))^{-3/4} f(t, 1-t),$$

for any non-negative Borel function  $f$  on  $\mathbb{R}_+^2$ .

*Démonstration.* We first explain how the loop  $\gamma_*$  is constructed. As in the previous section, write  $(g_{U_1, U_2}(r))_{0 \leq r \leq d_e(U_1, U_2)}$  for the geodesic path from  $p_e(U_1)$  to  $p_e(U_2)$  in the tree  $\mathcal{T}_e$ , whose range is the segment  $\llbracket p_e(U_1), p_e(U_2) \rrbracket$ . We already noticed that, conditionally on the triplet  $(e, U_1, U_2)$  the process

$$\left( Z_{g_{U_1, U_2}(r)} - Z_{p_e(U_1)} \right)_{0 \leq r \leq d_e(U_1, U_2)},$$



is a standard linear Brownian motion. Hence this process a.s. attains its minimal value at a unique time  $r_0 \in ]0, d_e(U_1, U_2)[$ , and we put  $\beta = g_{U_1, U_2}(r_0)$ . Since there are only countably many values of  $r \in ]0, d_e(U_1, U_2)[$  such that  $g_{U_1, U_2}(r)$  has multiplicity 3 in  $\mathcal{T}_e$ , it is also clear that  $\beta$  has multiplicity 2 in  $\mathcal{T}_e$ , a.s. Write  $\mathcal{C}_1^\circ$  and  $\mathcal{C}_2^\circ$  for the two connected components of  $\mathcal{T}_e \setminus \{\beta\}$ , ordered in such a way that  $p_e(U_1) \in \mathcal{C}_1^\circ$  and  $p_e(U_2) \in \mathcal{C}_2^\circ$ , and set  $\mathcal{C}_1 = \mathcal{C}_1^\circ \cup \{\beta\}$ ,  $\mathcal{C}_2 = \mathcal{C}_2^\circ \cup \{\beta\}$ . Then  $\Pi(\mathcal{C}_1)$  and  $\Pi(\mathcal{C}_2)$  are closed subsets of  $m_\infty$  whose union is  $m_\infty$ . Furthermore, the discussion at the beginning of Section 3 of [99] shows that the boundary of  $\Pi(\mathcal{C}_1)$ , or equivalently the boundary of  $\Pi(\mathcal{C}_2)$ , coincides with the set  $\Pi(\mathcal{C}_1) \cap \Pi(\mathcal{C}_2)$  of all points  $x \in m_\infty$  that can be written as  $x = \Pi(a_1) = \Pi(a_2)$  for some  $a_1 \in \mathcal{C}_1$  and  $a_2 \in \mathcal{C}_2$ . In particular, the interiors of  $\Pi(\mathcal{C}_1)$  and of  $\Pi(\mathcal{C}_2)$  are disjoint. Notice that  $\mathbf{p}(U_1)$  belongs to the interior of  $\Pi(\mathcal{C}_1)$ , and  $\mathbf{p}(U_2)$  belongs to the interior of  $\Pi(\mathcal{C}_2)$ , almost surely : To see this, observe that for almost every (in the sense of the volume measure Vol) point  $a$  of  $\mathcal{T}_e$ , the equivalence class of  $a$  for  $\approx$  is a singleton, and thus  $\Pi^{-1}(\mathbf{p}(U_1))$  and  $\Pi^{-1}(\mathbf{p}(U_2))$  must be singletons almost surely.

Since  $\beta$  has multiplicity 2 in  $\mathcal{T}_e$ , Theorem 7.6 in [99] implies that there are exactly two distinct geodesic paths from  $\rho_*$  to  $\Pi(\beta)$ , and that these paths are simple geodesics in the sense of [99, Section 4]. We denote these geodesic paths by  $\phi_1$  and  $\phi_2$ . From the definition of simple geodesics, one easily gets that  $\phi_1(s) = \phi_2(s)$  for every  $0 \leq s \leq s_0$ , where

$$s_0 := \max \left( \min_{a \in \mathcal{C}_1} Z_a, \min_{a \in \mathcal{C}_2} Z_a \right) - \underline{Z}.$$

Note that  $\{\phi_1(s) : 0 \leq s < s_0\}$  is contained in the interior of  $\Pi(\mathcal{C}_i)$ , where  $i \in \{1, 2\}$  is determined by the condition  $a_* \in \mathcal{C}_i$ . Furthermore, the definition of simple geodesics shows that

$$\Pi(\mathcal{C}_1) \cap \Pi(\mathcal{C}_2) = \{\phi_1(s) : s_0 \leq s \leq D(\rho_*, \Pi(\beta))\} \cup \{\phi_2(s) : s_0 \leq s \leq D(\rho_*, \Pi(\beta))\}.$$

We define  $\gamma_*$  by setting

$$\gamma_*(t) = \begin{cases} \phi_1(t) & \text{if } 0 \leq t \leq D(\rho_*, \Pi(\beta)), \\ \phi_2(2D(\rho_*, \Pi(\beta)) - t) & \text{if } D(\rho_*, \Pi(\beta)) \leq t \leq 2D(\rho_*, \Pi(\beta)). \end{cases}$$

Then  $\gamma_*$  is a loop starting and ending at  $\rho_*$ . Furthermore  $\gamma_*$  separates  $\mathbf{p}(U_1)$  and  $\mathbf{p}(U_2)$ , since any continuous path in  $m_\infty$  starting from  $\mathbf{p}(U_1)$  will have to hit the boundary of  $\Pi(\mathcal{C}_1)$  before reaching  $\mathbf{p}(U_2)$ . Finally the length of  $\gamma_*$  is

$$\begin{aligned} L(\gamma_*) &= 2D(\rho_*, \Pi(\beta)) = 2(Z_\beta - \underline{Z}) \\ &= D(\rho_*, \mathbf{p}(U_1)) + D(\rho_*, \mathbf{p}(U_2)) - 2 \, d_{\text{KAC}}(p_e(U_1), p_e(U_2)). \end{aligned}$$

We next verify that  $\gamma_*$  is the unique loop in  $S(\mathbf{p}(U_1), \mathbf{p}(U_2), \rho_*)$  with minimal length. Let  $\gamma$  be a path in  $S(\mathbf{p}(U_1), \mathbf{p}(U_2), \rho_*)$  indexed by the interval  $[0, T]$ . The image under  $\Pi$  of the path  $g_{U_1, U_2}$  is a continuous path from  $\mathbf{p}(U_1)$  to  $\mathbf{p}(U_2)$ , which must intersect the range of  $\gamma$ . Hence the range of  $\gamma$  contains at least one point  $y$  such that  $y = \Pi(a)$  for some  $a \in \llbracket p_e(U_1), p_e(U_2) \rrbracket$ . Since  $\gamma(0) = \gamma(T) = \rho_*$ , we have

$$L(\gamma) \geq 2D(\rho_*, y) = 2(Z_a - \underline{Z})$$

using property 1 of the distance  $D$  in Section 3.3. Since  $Z_a \geq Z_\beta$ , we thus obtain that  $L(\gamma) \geq L(\gamma_*)$ .

Let  $\tau \in [0, T]$  be such that  $y = \gamma(\tau)$ . The preceding considerations show that the equality  $L(\gamma) = L(\gamma_*)$  can hold only if  $a = \beta$  and if furthermore the paths  $(\gamma(\tau - t), 0 \leq t \leq \tau)$  and  $(\gamma(\tau + t), 0 \leq t \leq T - \tau)$  have length  $D(\rho_*, \Pi(\beta))$ , so that these paths must coincide (up to reparametrization) with geodesics from  $\Pi(\beta)$  to  $\rho_*$ . We conclude that any minimizing path  $\gamma$  coincides with  $\gamma_*$ , up to reparametrization and time-reversal.

In order to complete the proof of the theorem, we first need to identify the connected components of the complement of the range of  $\gamma_*$  in  $m_\infty$ . Consider the case when  $a_*$  belongs to  $\mathcal{C}_1$ , and set

$$\mathcal{R} := \{\phi_1(s) : 0 \leq s < s_0\} \subset \Pi(\mathcal{C}_1).$$

Write  $\text{Int}(\Pi(\mathcal{C}_i))$  for the interior of  $\Pi(\mathcal{C}_i)$ , for  $i = 1, 2$ . Then the connected components of the complement of the range of  $\gamma_*$  in  $m_\infty$  are

$$C_1 = \text{Int}(\Pi(\mathcal{C}_1)) \setminus \mathcal{R}, \quad C_2 = \text{Int}(\Pi(\mathcal{C}_2)).$$

This easily follows from the preceding considerations : Note for instance that  $\text{Int}(\Pi(\mathcal{C}_2))$  is the image under  $\Pi$  of a connected subset of  $\mathcal{C}_2$ , and is therefore connected. From this identification, we get

$$\lambda(C_1) = \text{Vol}(\mathcal{C}_1), \quad \lambda(C_2) = \text{Vol}(\mathcal{C}_2) = 1 - \text{Vol}(\mathcal{C}_1), \quad (3.19)$$

using the fact that the range of  $\gamma_*$  has zero  $\lambda$ -measure (this can be seen from the uniform estimates on the measure of balls found in Section 6 of [99]). Clearly the same identities (3.19) remain valid in the case when  $a_*$  belongs to  $\mathcal{C}_2$ .

To complete the proof, we need to compute the distribution of  $\text{Vol}(\mathcal{C}_1)$ . To this end it will be convenient to use the invariance of the law of  $\mathcal{T}_e$  under uniform re-rooting (see e.g. [103]). Let  $U$  be a random variable uniformly distributed over  $[0, 1]$ , and let  $\alpha$  be the (almost surely unique) vertex of  $[[p_e(0), p_e(U)]]$  such that  $Z_\alpha = \min_{a \in [[p_e(0), p_e(U)]]} Z_a$ . Then, if  $\mathcal{C}^\circ$  is the connected component of  $\mathcal{T}_e \setminus \{\alpha\}$  containing  $p_e(U)$ , the invariance of the CRT under uniform re-rooting implies that

$$\text{Vol}(\mathcal{C}_1) \stackrel{(d)}{=} \text{Vol}(\mathcal{C}^\circ).$$

Now notice that conditionally on the pair  $(e, U)$ , the random variable  $H = d_e(p_e(0), \alpha)$  is distributed according to the arc-sine law on  $[0, e_U]$ , with density

$$\frac{1}{\pi \sqrt{s(e_U - s)}}.$$

Moreover,

$$\text{Vol}(\mathcal{C}^\circ) = D_e(U, e_U - H) - G_e(U, e_U - H)$$

where we use the same notation as in the preceding section, for  $r \in ]0, 1[$  and  $u \in [0, e_r]$ ,

$$\begin{aligned} G_e(r, u) &= \max\{s \leq r : e_s = e_r - u\}, \\ D_e(r, u) &= \min\{s \geq r : e_s = e_r - u\}. \end{aligned} \quad (3.20)$$

From the previous remarks, we have, for any non-negative measurable function  $g$  on  $[0, 1]$ ,

$$\mathbb{E} [g(\text{Vol}(\mathcal{C}_1))] = \mathbb{E} [g(\text{Vol}(\mathcal{C}^\circ))] = \mathbb{E} \left[ \int_0^1 ds \int_0^{e_s} \frac{dh}{\pi \sqrt{h(e_s - h)}} g(D_{\mathbf{e}}(s, h) - G_{\mathbf{e}}(s, h)) \right]. \quad (3.21)$$

In order to compute the right-hand side, it is convenient to argue first under the Itô measure  $n(de)$  of positive excursions of linear Brownian motion (see e.g. Chapter XII of [123], where the notation  $n_+(de)$  is used). Let  $\sigma(e)$  denote the duration of excursion  $e$ , and define  $D_e(r, u)$  and  $G_e(r, u)$ , for  $r \in ]0, \sigma(e)[$  and  $0 \leq u \leq e(r)$ , in a way analogous to (3.20). Also write

$$q_h(t) = \frac{h}{\sqrt{2\pi t^3}} \exp -\frac{h^2}{2t}$$

for the density of the hitting time of  $h > 0$  by a standard linear Brownian motion. Then, an application of Bismut’s decomposition of the Itô measure, in the form stated in [95, Lemma 1], gives for every non-negative measurable function  $f$  on  $\mathbb{R}_+^2$ ,

$$\begin{aligned} & \int n(de) \int_0^{\sigma(e)} ds \int_0^{e(s)} \frac{dh}{\pi \sqrt{h(e(s) - h)}} f(\sigma(e), D_e(s, h) - G_e(s, h)) \\ &= \int_0^\infty du \int_0^u \frac{dh}{\pi \sqrt{h(u - h)}} \int_0^\infty dt q_{2h}(t) \int_0^\infty dt' q_{2(u-h)}(t') f(t + t', t) \\ &= \frac{1}{\pi} \int_0^\infty \frac{dh}{\sqrt{h}} \int_0^\infty \frac{dh'}{\sqrt{h'}} \int_0^\infty dt q_{2h}(t) \int_0^\infty dt' q_{2h'}(t') f(t + t', t) \\ &= \frac{1}{\pi} \int_0^\infty dt \int_0^\infty dt' f(t + t', t) \left( \int_0^\infty \frac{dh}{\sqrt{h}} q_{2h}(t) \right) \left( \int_0^\infty \frac{dh'}{\sqrt{h'}} q_{2h'}(t') \right). \end{aligned} \quad (3.22)$$

We easily compute

$$\int_0^\infty \frac{dh}{\sqrt{h}} q_{2h}(t) = 2^{-3/4} (2\pi)^{-1/2} \Gamma(3/4) t^{-3/4}.$$

Hence, using also the identity  $\Gamma(1/4)\Gamma(3/4) = \pi\sqrt{2}$ , we see that the right-hand side of (3.22) is equal to

$$\frac{2^{-3/2}}{\Gamma(1/4)^2} \int_0^\infty d\ell \int_0^\ell dt f(\ell, t) (t(\ell - t))^{-3/4}.$$

We can condition the resulting formula on  $\{\sigma = 1\}$ , using the fact that the density of  $\sigma(e)$  under  $n(de)$  is equal to  $\frac{1}{2}(2\pi\ell^3)^{-1/2}$ , and we conclude that

$$\begin{aligned} & \mathbb{E} \left[ \int_0^1 ds \int_0^{e_s} \frac{dh}{\pi \sqrt{h(e_s - h)}} g(D_{\mathbf{e}}(s, h) - G_{\mathbf{e}}(s, h)) \right] \\ &= n \left( \int_0^{\sigma(e)} ds \int_0^{e(s)} \frac{dh}{\pi \sqrt{h(e(s) - h)}} g(D_e(s, h) - G_e(s, h)) \mid \sigma = 1 \right) \\ &= \frac{\sqrt{\pi}}{\Gamma(1/4)^2} \int_0^1 dt (t(1 - t))^{-3/4} g(t). \end{aligned}$$

We now see that the last assertion of the theorem follows from (3.21). □

### 3.7 Appendix

This section is devoted to the proof of the fact, mentioned in Section 3.20, that if  $\mathbf{q} = (q_1, q_2, \dots)$  is a sequence with finite support, such that  $q_k > 0$  for some  $k \geq 3$ , then there exists a constant  $a > 0$  such that  $a\mathbf{q} = (aq_1, aq_2, \dots)$  is regular critical in the sense of [109, 114]. We briefly discuss case (A2), which is easier. Following [109], we define

$$f_{\mathbf{q}}(x) = \sum_{k \geq 0} x^k \binom{2k+1}{k} q_{2k+2}, \quad x \geq 0.$$

By [109, Proposition 1], the Boltzmann measure  $W_{\mathbf{q}}$  defined in Section 3.20 is a finite measure if and only if the equation

$$f_{\mathbf{q}}(x) = 1 - \frac{1}{x}, \quad x > 1. \tag{3.23}$$

has a solution. Since  $q_k > 0$  for some  $k \geq 3$ , the function  $f_{\mathbf{q}}$  is a strictly convex polynomial, so there can be either one or two solutions to this equation. In the first situation, the graphs of  $f_{\mathbf{q}}$  and  $x \mapsto 1 - 1/x$  are tangent at the unique solution, in which case  $\mathbf{q}$  is said to be critical in the sense of [109, Definition 1] (it will even be *regular* critical in our case since  $f_{\mathbf{q}}(x)$  is finite for every  $x > 0$ ). It is then trivial that there exists a unique  $a = a_c > 0$  such that the graphs of  $f_{a\mathbf{q}}$  and  $x \mapsto 1 - 1/x$  intersect at a tangency point, and then  $a_c\mathbf{q}$  is regular critical.

Let us turn to case (A1), which is more delicate. For every  $x, y \geq 0$ , we set

$$\begin{aligned} f_{\mathbf{q}}^{\bullet}(x, y) &= \sum_{k, k' \geq 0} x^k y^{k'} \binom{2k+k'+1}{k+1} \binom{k+k'}{k} q_{2+2k+k'} \\ f_{\mathbf{q}}^{\circlearrowleft}(x, y) &= \sum_{k, k' \geq 0} x^k y^{k'} \binom{2k+k'}{k} \binom{k+k'}{k} q_{1+2k+k'}, \end{aligned}$$

defining two convex polynomials in the variables  $x$  and  $y$ . Proposition 1 of [114] asserts that the Boltzmann measure  $W_{\mathbf{q}}$  is finite (then  $\mathbf{q}$  is said to be *admissible*) if and only if the equations

$$\begin{cases} f_{\mathbf{q}}^{\bullet}(x, y) = 1 - \frac{1}{x}, & x > 1 \\ f_{\mathbf{q}}^{\circlearrowleft}(x, y) = y, & y > 0 \end{cases} \tag{3.24}$$

have a solution  $(x, y)$ , such that the spectral radius of the matrix

$$M(x, y) = \begin{pmatrix} 0 & 0 & x-1 \\ \frac{x}{y} \partial_x f_{\mathbf{q}}^{\circlearrowleft}(x, y) & \partial_y f_{\mathbf{q}}^{\circlearrowleft}(x, y) & 0 \\ \frac{x^2}{x-1} \partial_x f_{\mathbf{q}}^{\bullet}(x, y) & \frac{xy}{x-1} \partial_y f_{\mathbf{q}}^{\bullet}(x, y) & 0 \end{pmatrix}$$

is at most 1. Moreover, a solution  $(x, y)$  with these properties is then unique.

If the spectral radius of  $M(x, y)$  (for this unique solution  $(x, y)$ ) equals 1, then we say that  $\mathbf{q}$  is critical. It is here even *regular* critical in the terminology of [114], since the functions  $f_{\mathbf{q}}^{\bullet}, f_{\mathbf{q}}^{\circlearrowleft}$  are everywhere finite in our case. Note that the matrix  $M(x, y)$  has

nonnegative coefficients, and the Perron-Frobenius theorem ensures that the spectral radius of  $M(x, y)$  is also the largest real eigenvalue of  $M(x, y)$ . Thus, assuming that  $\mathbf{q}$  is admissible, and letting  $(x, y)$  be the unique solution of (3.24) such that  $M(x, y)$  has spectral radius bounded by 1, we see that  $\mathbf{q}$  is regular critical if and only if 1 is an eigenvalue of  $M(x, y)$ , which holds if and only if the determinant of  $\text{Id} - M(x, y)$  vanishes.

For every  $x, y > 0$ , set

$$G(x, y) = f_{\mathbf{q}}^{\bullet}(x, y) - 1 + 1/x \quad \text{and} \quad H(x, y) = f_{\mathbf{q}}^{\circ}(x, y) - y.$$

Then  $G$  and  $H$  are convex functions on  $(0, \infty)^2$ . A pair  $(x, y) \in (0, \infty)^2$  satisfies (3.24) if and only if  $G(x, y) = H(x, y) = 0$  (notice that the condition  $G(x, y) = 0$  forces  $x > 1$ ). The set  $\{G = 0\}$ , resp.  $\{H = 0\}$  is the boundary of the closed convex set  $C_G = \{G \leq 0\}$ , resp. of  $C_H = \{H \leq 0\}$ , in  $(0, \infty)^2$ .

**Lemma 3.28.** (i) *The set  $C_G$  is contained in  $(1, \infty) \times (0, A)$ , for some  $A > 0$ .*

(ii) *The set  $C_H$  is bounded.*

(iii) *If  $(x, y) \in C_G$  then  $(x, y') \in C_G$  for every  $y' \in (0, y)$ . If  $(x, y) \in C_H$  then  $(x', y) \in C_H$  for every  $x' \in (0, x)$ . There exists  $\varepsilon > 0$  such that  $C_H$  does not intersect  $[1, \infty) \times (0, \varepsilon)$ .*

(iv) *For every  $a > 0$ , let  $G_a$ , resp.  $H_a$ , be the function analogous to  $G$ , resp. to  $H$ , when  $\mathbf{q}$  is replaced by  $a\mathbf{q}$ . Then  $C_{H_a} \subset (0, 1] \times (0, \infty)$  for every large enough  $a > 0$ . Consequently  $C_{H_a} \cap C_{G_a} = \emptyset$  for every large enough  $a > 0$ .*

*Démonstration.* (i) This is obvious since  $f_{\mathbf{q}}^{\bullet}(x, y) \geq C y^{\ell}$  for every  $x, y > 0$ , for some constant  $C > 0$  and some integer  $\ell \geq 3$ .

(ii) Suppose first that there exists an odd integer  $\ell \geq 3$  such that  $q_{\ell} > 0$ . Then, the definition of  $f_{\mathbf{q}}^{\circ}$  shows that there is a positive constant  $c$  such that

$$f_{\mathbf{q}}^{\circ}(x, y) \geq c(x^{(\ell-1)/2} + y^{\ell-1}),$$

and it readily follows that  $C_H$  is bounded. Consider then the case when there is an even integer  $\ell \geq 4$  such that  $q_{\ell} > 0$ . Then there is a positive constant  $c$  such that

$$f_{\mathbf{q}}^{\circ}(x, y) \geq c(x^{(\ell-2)/2}y + y^{\ell-1}),$$

and again this implies that  $C_H$  is bounded.

(iii) The first property is clear since  $y \mapsto G(x, y)$  is non-decreasing, for every  $y > 0$ . Similarly, the second property in (iii) follows from the fact that  $x \mapsto H(x, y)$  is non-decreasing, for every  $x > 0$ . The last property is also clear since we can find  $\varepsilon > 0$  such that  $f_{\mathbf{q}}^{\circ}(x, y) > \varepsilon$  for every  $x \geq 1$  and  $y > 0$  (we use the fact that  $\mathbf{q}$  is not supported on even integers).

(iv) Suppose first that there there exists an odd integer  $\ell \geq 3$  such that  $q_{\ell} > 0$ . Using the same bound as in the proof of (ii), and noting that  $f_{a\mathbf{q}}^{\circ} = a f_{\mathbf{q}}^{\circ}$ , we see that  $H_a(x, y) \leq 0$  can only hold if

$$x^{(\ell-1)/2} + y^{\ell-1} \leq \frac{y}{ca}.$$

It is elementary to check that this implies  $x \leq 1$  as soon as  $a$  is large enough. The case when there is an even integer  $\ell \geq 4$  such that  $q_\ell > 0$  is treated similarly using the bound stated in the proof of (ii). Finally the last assertion in (iv) follows by using (i).  $\square$

Recall that  $f_{\mathbf{q}}^\bullet$  and  $f_{\mathbf{q}}^\circ$  are polynomials. It follows that the set  $\{G = 0\}$  is either empty or a smooth curve depending on whether the set  $\{G \leq 0\}$  is empty or not (a priori it could happen that  $\{G = 0\} = \{G \leq 0\}$  is a singleton, but assertion (iii) in the previous lemma shows that this case does not occur). Similar properties hold for the set  $\{H = 0\}$ . A simple calculation also shows that

$$\det(\text{Id} - M(x, y)) = x^2 \det(\nabla G(x, y), \nabla H(x, y)). \tag{3.25}$$

Consequently, if we assume that  $(x, y)$  satisfies (3.24), the condition  $\det(\text{Id} - M(x, y)) = 0$  will hold if and only if the curves  $C_G$  and  $C_H$  are tangent at  $(x, y)$ .

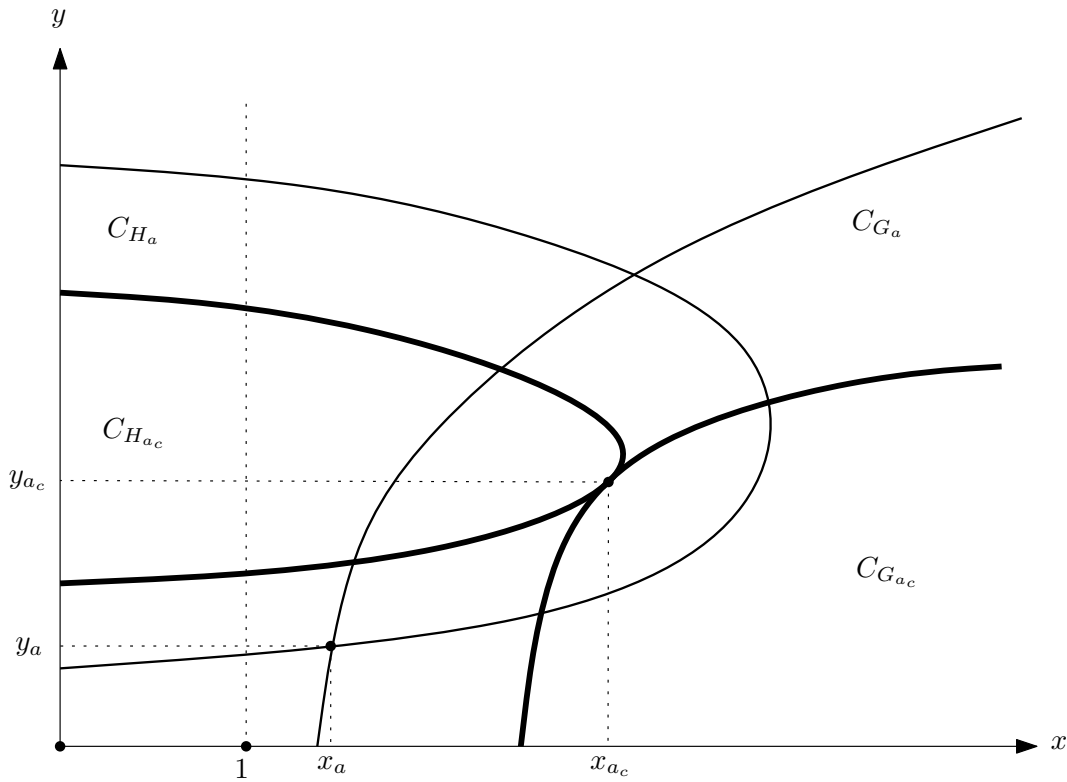

FIGURE 3.4 – Illustration of the sets  $C_{G_a}$  and  $C_{H_a}$  for  $0 < a < a_c$  and for  $a = a_c$

**Proposition 3.29.** *Under Assumption (A1), there exists a unique positive real  $a_c$  such that  $a_c \mathbf{q}$  is regular critical.*

*Démonstration.* For every  $a > 0$ , write  $M_a(x, y)$  for the analogue of the matrix  $M(x, y)$  when  $\mathbf{q}$  is replaced by  $a\mathbf{q}$ . Simple counting arguments (using for instance the BDG

bijections and the fact that the sequence  $\mathbf{q}$  has finite support, so that the degrees of faces in maps  $m$  such that  $W_{\mathbf{q}}(m) > 0$  are bounded) show that the Boltzmann measure  $W_{a\mathbf{q}}$  is finite for  $a > 0$  small enough. Consequently we can fix  $a_0 > 0$  small enough so that  $a_0\mathbf{q}$  is admissible. By previous observations, there exists a pair  $(x_{a_0}, y_{a_0})$  belonging to the intersection of the curves  $\{G_{a_0} = 0\}$  and  $\{H_{a_0} = 0\}$  and such that the spectral radius of the matrix  $M_{a_0}(x_{a_0}, y_{a_0})$  is bounded above by 1. If the curves  $\{G_{a_0} = 0\}$  and  $\{H_{a_0} = 0\}$  are tangent at  $(x_{a_0}, y_{a_0})$ , then (3.25) shows that this spectral radius is equal to 1, and thus  $a_0\mathbf{q}$  is regular critical.

Suppose that the curves  $\{G_{a_0} = 0\}$  and  $\{H_{a_0} = 0\}$  are not tangent at  $(x_{a_0}, y_{a_0})$ . Then, convexity arguments, using properties (i)–(iii) in Lemma 3.28, show that the intersection of  $\{G_{a_0} = 0\}$  and  $\{H_{a_0} = 0\}$  consists of exactly two points  $(x_{a_0}, y_{a_0})$  and  $(x'_{a_0}, y'_{a_0})$ . By (3.25) and the fact that the spectral radius of  $M_{a_0}(x_{a_0}, y_{a_0})$  is bounded above by 1, we have

$$\det(\nabla G_{a_0}(x_{a_0}, y_{a_0}), \nabla H_{a_0}(x_{a_0}, y_{a_0})) > 0,$$

and simple geometric considerations show that  $(x_{a_0}, y_{a_0})$  must be the “first” intersection point of  $\{G_{a_0} = 0\}$  and  $\{H_{a_0} = 0\}$ , in the sense that  $x_{a_0} \leq x'_{a_0}$  and  $y_{a_0} \leq y'_{a_0}$ .

Note that both sets  $G_a$  and  $H_a$  are decreasing functions of  $a$ , and vary continuously with  $a$  (as long as they are non-empty). Geometric arguments, together with property (iv) of Lemma 3.28, show that there exists a critical value  $a_c > a_0$  such that for  $a_0 \leq a < a_c$  the curves  $\{G_a = 0\}$  and  $\{H_a = 0\}$  intersect at exactly two points, denoted by  $(x_a, y_a)$  and  $(x'_a, y'_a)$ , such that  $x_a \leq x'_a$  and  $y_a \leq y'_a$ , and furthermore the curves  $\{G_{a_c} = 0\}$  and  $\{H_{a_c} = 0\}$  are tangent at a point denoted by  $(x_{a_c}, y_{a_c})$ . Moreover the mapping  $a \mapsto (x_a, y_a)$  is continuous on  $[a_0, a_c]$ . It follows that the spectral radius of  $M_a(x_a, y_a)$  remains bounded above by 1 for  $a \in [a_0, a_c]$ : If this were not the case, this spectral radius would take the value 1 at some  $a_1 \in (a_0, a_c)$  but then by (3.25) the curves  $\{G_{a_1} = 0\}$  and  $\{H_{a_1} = 0\}$  would be tangent at  $(x_{a_1}, y_{a_1})$ , which is a contradiction. Finally by letting  $a \uparrow a_c$  we get that the spectral radius of  $M_{a_c}(x_{a_c}, y_{a_c})$  is bounded above by 1, hence equal to 1 by (3.25) and the fact that  $\{G_{a_c} = 0\}$  and  $\{H_{a_c} = 0\}$  are tangent at  $(x_{a_c}, y_{a_c})$ . We conclude that  $a_c\mathbf{q}$  is regular critical.

The uniqueness of  $a_c$  is clear since we can start the previous argument from an arbitrarily small value of  $a_0$  and since the curves  $\{G_a = 0\}$  and  $\{H_a = 0\}$  will not intersect when  $a > a_c$ .  $\square$

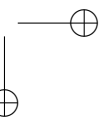
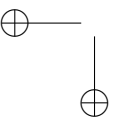
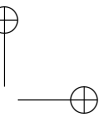
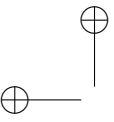



# On limits of Graphs Sphere Packed in Euclidean Space and Applications

---

LES RÉSULTATS DE CE CHAPITRE ONT ÉTÉ OBTENUS EN COLLABORATION AVEC ITAI BENJAMINI ET ONT ÉTÉ ACCEPTÉS POUR PUBLICATION DANS *European Journal of Combinatorics*.

The core of this note is the observation that links between circle packings of graphs and potential theory developed in [21] and [77] can be extended to higher dimensions. In particular, it is shown that every limit of finite graphs sphere packed in  $\mathbb{R}^d$  with a uniformly-chosen root is  $d$ -parabolic. We then derive few geometric corollaries. E.g. every infinite graph packed in  $\mathbb{R}^d$  has either strictly positive isoperimetric Cheeger constant or admits arbitrarily large finite sets  $W$  with boundary size which satisfies  $|\partial W| \leq |W|^{\frac{d-1}{d} + o(1)}$ . Some open problems and conjectures are gathered at the end.

## 4.1 Introduction

The theory of random planar graphs, also known as two-dimensional quantum gravity in the physics literature, has been rapidly developing for the last ten years, see [15] for a survey. The analogous theory in higher dimension is notoriously hard and not much established so far, this is due in particular to the fact that enumeration techniques and bijective representations are missing, see for instance [14].

However there are a couple of two dimensional results that are not depending on enumeration. E.g. in [21], circle packing theory is used to show that limits (see Definition 4.2.3) of finite random *planar* graphs of bounded degree with a uniformly-chosen root are almost surely recurrent. The goal of this note is to extend this result into higher dimensions and to draw some consequences and conjectures.

We recall that recurrence means that the simple random walk on the graph returns to the origin almost surely, or in a potential theory terminology that the graph is parabolic. A graph is parabolic if and only if it supports no flow with one source of flux 1, no sinks, and with gradient in  $\mathbb{L}^2$ . Replacing 2 by  $d \geq 3$  yields to the concept of  $d$ -parabolicity, see [133] and Section 4.2.2.

The analogous of circle packing theory in dimension  $d$  is easy to describe. A graph is sphere packable in  $\mathbb{R}^d$  if and only if it is the tangency graph of a collection of  $d$ -dimensional balls with disjoint interiors : the balls of the packing correspond to the

vertices of the graph and the edges to tangent balls, see Section 4.2.1. The theory of circle packings of planar graphs is well developed and its relation to conformal geometry is well established, see the beautiful survey [126]. The higher dimensional version is not as neat. First, although all finite planar graphs (without loops nor multiple edges) can be realized as the tangency graph of a circle packing in  $\mathbb{R}^2$  (see below), yet there are no natural families of graph packed in  $\mathbb{R}^d$  for  $d \geq 3$ . Second, circle packings relates to  $\mathbb{L}^2$  potential theory while in higher dimension the link is to  $d$ -potential theory, which is less natural and where the probabilistic interpretation is lacking. Still useful things can be proved and conjectured. Indeed the main observation of this note is that links between circle packings of graphs and potential theory over the graph (see [77]) can be extended to higher dimensions, leading in particular to a generalization of [21, Theorem 1.1] and suggests many problems for further research. For a precise formulation of our main theorem (Theorem 4.9) we must introduce several technical notions and definitions in the coming sections.

We hope that this minor contribution will open the doors for three and higher dimensional theory of sphere packing and quantum gravity. The proofs essentially follow that of [21] and [77] with the proper modifications followed by a report on some new geometric applications. For example we prove under a local bounded geometry assumption defined in the next section that a sequence of  $k$ -regular graphs with growing girth can not be all packed in a fixed dimension and that every infinite graph packed in  $\mathbb{R}^d$  either has strictly positive isoperimetric Cheeger constant or admits arbitrarily large finite sets  $W$  with boundary size which satisfies  $|\partial W| \leq |W|^{\frac{d-1}{d} + o(1)}$ .

Note that very recently the isoperimetric criterion of Proposition 4.14 was used in [88] to prove that acute triangulations of the space  $\mathbb{R}^d$  do not exist for  $d \geq 5$ .

## 4.2 Notations and terminology

In the following, unless indicated, all graphs are locally finite and connected.

### 4.2.1 Packings

**Definition 4.1.** *A  $d$ -dimensional sphere packing or shortly  $d$ -sphere packing is a collection  $P = (B_v, v \in V)$  of  $d$ -dimensional balls of centers  $C_v$  and radii  $r_v > 0$  with disjoint interiors in  $\mathbb{R}^d$ . We associated to  $P$  an unoriented graph  $G = (V, E)$  called tangency graph, where we put an edge between two vertices  $u$  and  $v$  if and only if the balls  $B_u$  and  $B_v$  are tangent.*

An *accumulation point* of a sphere packing  $P$  is an accumulation point of the centers of the balls of  $P$ . Note that the name “sphere packing” is unfortunate since it deals with balls. However this terminology is common and we will use it. The 2-dimensional case is well-understood, thanks to the following Theorem.

**Theorem 4.2** (Circle Packing Theorem). *A finite graph  $G$  is the tangency graph of a 2-sphere packing if and only if  $G$  is planar and contains no multiple edges nor loops. Moreover if  $G$  is a triangulation then this packing is unique up to Möbius transformations.*

This beautiful result has a long history, we refer to [137] and [126] for further information. When  $d = 3$ , very little is known. Although some necessary conditions for a finite graph to be the tangency graph of a 3-sphere packing are provided in [92] (for a related higher dimensional result see [8]), the characterization of 3-sphere packable graphs is still open (see last section). For packing of infinite graphs see [22]. To bypass the lack of a result similar to the last theorem in dimension 3 or higher, we will restrict ourselves to packable graphs, that are graphs which admit a sphere packing representation. One useful lemma in circle packing theory is the so-called “Ring lemma” that enables us to control the size of tangent circles under a bounded-degree assumption.

**Lemma 4.3** (Ring Lemma, [125]). *There is a constant  $r > 0$  depending only on  $n \in \mathbb{Z}_+$  such that if  $n$  circles surround the unit disk then each circle has radius at least  $r$ .*

Here also, since we have no analogous of the Ring Lemma in high dimensions, we will require an additional property on the packings.

**Definition 4.4.** *Let  $M > 0$ . A  $d$ -sphere packing  $P = (B_v, v \in V)$  is  $M$ -uniform if, for any tangent balls  $B_u$  and  $B_v$  of radii  $r_u$  and  $r_v$  we have*

$$\frac{r_u}{r_v} \leq M.$$

*A graph  $G$  is  $M$ -uniform in dimension  $d$ , if it is a tangency graph of a  $M$ -uniform sphere packing in  $\mathbb{R}^d$ .*

**Remark 4.5.** *Note that an  $M$ -uniform graph in dimension  $d$  has a maximal degree bounded by a constant depending only on  $M$  and  $d$ .*

**Remark 4.6.** *By the Ring Lemma, every planar graph of bounded degree without loops nor multiple edges is  $M$ -uniform in dimension 2, where  $M$  only depends of the maximal degree of the graph. The same holds in dimension 3 provided that the complex generated by the centers of the spheres is a tetrahedrangement (that is all simplexes of dimension 3 are tetrahedrons), see [144].*

#### 4.2.2 $d$ -parabolicity

The classical theory of electrical networks and 2-potential theory is long studied and well understood, in particular due to the connection with simple random walk (see for example [57] for a nice introduction). On the other hand, non-linear potential theory is much more complicated and still developing, for background see [133]. A key concept for  $d$ -potential theory is the notion of extremal length and its relations with parabolicity (extremal length is common in complex analysis and was imported in the discrete setting by Duffin [58]). We present here the basic definitions that we use in the sequel.

Let  $G = (V, E)$  be a locally finite connected graph. For  $v \in V$  we let  $\Gamma(v)$  be the set of all semi-infinite self-avoiding paths in  $G$  starting from  $v$ . If  $m : V \rightarrow \mathbb{R}_+$  is assigning length to vertices, the length of a path  $\gamma$  in  $G$  :

$$\text{Length}_m(\gamma) := \sum_{v \in \gamma} m(v).$$

If  $m \in \mathbb{L}^d(V)$ , we denote by  $\|m\|_d$  the usual  $\mathbb{L}^d$  norm  $(\sum_v m(v)^d)^{1/d}$ . The graph  $G$  is  $d$ -parabolic if the  $d$ -vertex extremal length of  $\Gamma(v)$ ,

$$d\text{-VEL}(\Gamma)(v) := \sup_{m \in \mathbb{L}^d} \inf_{\gamma \in \Gamma(v)} \frac{\text{Length}_m(\gamma)^d}{\|m\|_d^d}$$

is infinite. It is easily seen that this definition does not depend upon the choice of  $v \in V$ . This natural extension of VEL parabolicity from [77] can be found earlier in [22].

**Remark 4.7.** *In the context of bounded degree graphs, 2-parabolicity is equivalent to recurrence of the simple random walk on the graph, see [77] and the references therein. In general, 2-VEL is closely related to discrete conformal structures such as circle packings and square tilings, see [20, 39, 128].*

### 4.2.3 Limit of graphs

A rooted graph  $(G = (V, E), o \in V)$  is isomorphic to  $(G' = (V', E'), o' \in V')$  if there is a graph-isomorphism of  $G$  onto  $G'$  which takes  $o$  to  $o'$ . We can define (as introduced in [21]) a distance  $\Delta$  on the space of isomorphism classes of locally finite rooted graphs by setting

$$\Delta((G, o), (G', o')) = \left(1 + \sup \{k : \text{Ball}_G(o, k) \text{ isomorphic to } \text{Ball}_{G'}(o', k)\}\right)^{-1},$$

where  $\text{Ball}_G(o, k)$  is the closed combinatorial ball of radius  $k$  around  $o$  in  $G$  for the graph distance. In this work, limits of graph should be understood as referring to  $\Delta$ . It is easy to see that the space of isomorphism classes of rooted graphs with maximal degree less than  $M$  is compact with respect to  $\Delta$ . In particular every sequence of random rooted graphs of degree bounded by  $M$  admits weak limits.

**Definition 4.8.** *A random rooted graph  $(G, o)$  is unbiased if  $(G, o)$  is almost surely finite and conditionally on  $G$ , the root  $o$  is uniform over all vertices of  $G$ .*

We are now ready to state our main result. The case  $d = 2$  is [21, Theorem 1].

**Theorem 4.9.** *Let  $M \geq 0$  and  $d \in \{2, 3, \dots\}$ . Let  $(G_n, o_n)_{n \geq 0}$  be a sequence of unbiased random rooted graphs such that, almost surely, for all  $n \geq 0$ ,  $G_n$  is  $M$ -uniform in dimension  $d$ . If  $(G_n, o_n)$  converges in distribution towards  $(G, o)$  then  $G$  is almost surely  $d$ -parabolic.*

Applications of Theorem 4.9 will be discussed in Section 4.

## 4.3 Proof of Theorem 4.9

We follow the structure of the proof of [21, Theorem 1] :

1. We first construct a limiting random packing whose tangency graph *contains* the limit of the finite graphs.
2. The main step consists in showing that this packing has at most one accumulation point (for the centers) in  $\mathbb{R}^d$ , almost surely.

3. Finally we conclude by quoting a theorem relating packing in  $\mathbb{R}^d$  and  $d$ -parabolicity. Let  $(G_n, o_n)_{n \geq 0}$  be a sequence of unbiased,  $M$ -uniform in dimension  $d$ , random rooted graphs converging to a random rooted graph  $(G, o)$ . Given  $G_n$ , let  $P_n$  be a deterministic  $M$ -uniform packing of  $G_n$  in  $\mathbb{R}^d$ . We can assume that  $o_n$  is independent of  $P_n$ .

Suppose that  $C \subset \mathbb{R}^d$  is a finite set of points (in the application below,  $C$  will be the set of centers of balls in  $P_n$ ). When  $w \in C$ , we define its isolation radius as  $\rho_w := \inf\{|v - w| : v \in C \setminus \{w\}\}$ . Given  $\delta \in (0, 1)$ ,  $s > 0$  and  $w \in C$ , following [21] we say that  $w$  is  $(\delta, s)$ -supported if in the ball of radius  $\delta^{-1}\rho_w$  centered at  $w$ , there are more than  $s$  points of  $C$  outside of every ball of radius  $\delta\rho_w$ ; that is, if

$$\inf_{p \in \mathbb{R}^d} \left| C \cap \text{Ball}_{\mathbb{R}^d}(w, \delta^{-1}\rho_w) \setminus \text{Ball}_{\mathbb{R}^d}(p, \delta\rho_w) \right| \geq s.$$

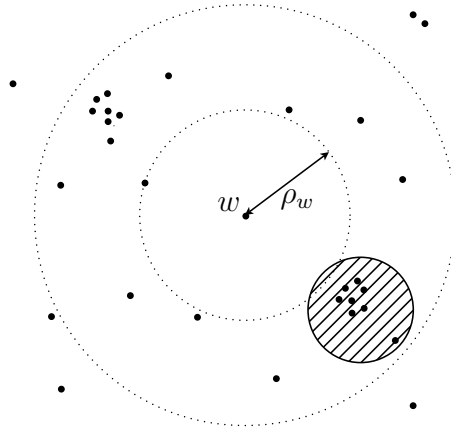

FIG. 1 : Illustration of the definition of  $(\delta, s)$ -supported. Here, the point  $w$  is  $(0.5, 10)$ -supported

**Lemma 4.10** ([21]). *Let  $d \geq 2$ . For every  $\delta \in (0, 1)$  there is a constant  $c(\delta, d)$  such that for every finite set  $C \subset \mathbb{R}^d$  and every  $s \geq 2$  the set of  $(\delta, s)$ -supported points in  $C$  has cardinality at most  $c(\delta, d)|C|/s$ .*

Lemma 2.3 in [21] deals with the case  $d = 2$ , but the proof when  $d \geq 2$  is the same and is therefore omitted.

Now, thanks to this lemma and to the fact that the point  $o_n$  has been chosen independently of the packing  $P_n$ , for any  $\delta > 0$  and any  $n \geq 0$ , the probability that the center of the ball  $B_{o_n}$  is  $(\delta, s)$ -supported in the centers of  $P_n$  goes to 0 as  $s \rightarrow \infty$ . Let  $\tilde{P}_n$  be the image of  $P_n$  under a linear mapping so that the ball  $B_{o_n}$  is the unit ball in  $\mathbb{R}^d$ . Since the definition of  $(\delta, s)$ -supported is invariant under dilations and translations, we have

$$\mathbb{P}(0 \text{ is } (\delta, s)\text{-supported in the centers of } \tilde{P}_n) \xrightarrow{s \rightarrow \infty} 0. \tag{4.1}$$

Let  $\tilde{\mathbf{P}}_n$  be the union of the spheres of the packing  $\tilde{P}_n$  and  $\tilde{\mathbf{C}}_n$  be the union of the centers of the spheres of  $\tilde{P}_n$ . By definition,  $\tilde{\mathbf{P}}_n$  and  $\tilde{\mathbf{C}}_n$  are random closed subsets of  $\mathbb{R}^d$ . The topology of Hausdorff convergence on every compact of  $\mathbb{R}^d$  is a compact topology for closed subsets of  $\mathbb{R}^d$ . Hence, we can assume that along a subsequence we have the following convergence in distribution

$$((G_n, o_n), \tilde{\mathbf{P}}_n, \tilde{\mathbf{C}}_n) \xrightarrow[n \rightarrow \infty]{} ((G, o), \mathbf{P}, \mathbf{C}), \tag{4.2}$$

related to  $\Delta$  for the first component and to the Hausdorff convergence on every compact of  $\mathbb{R}^d$  for the second and third ones. Without loss of generality we can suppose that there is no need to pass to a subsequence and by Skorhokhod representation theorem that the convergence (4.2) is almost sure.

**Proposition 4.11.** *The random closed set  $\mathbf{P}$  is almost surely the closure of a sphere packing in  $\mathbb{R}^d$  whose centers have at most one accumulation point in  $\mathbb{R}^d$ . Furthermore, the tangency graph associated to  $\mathbf{P}$  almost surely contains  $(G, o)$  as a subgraph.*

*Démonstration.* We begin with the second claim of the proposition. By definition of  $\tilde{P}_n$  we know  $\mathbf{P}$  contains the unit sphere of  $\mathbb{R}^d$  that corresponds to  $o \in G$ . Since the packings  $\tilde{P}_n$  are  $M$ -uniform, any vertex neighbor of  $o_n$  in  $G_n$  corresponds to ball in the packing whose radius is in  $[M^{-1}, M]$  and tangent to the unit ball of  $\mathbb{R}^d$ . This property passes to the limit and by (4.2) we deduce that any neighbor of  $o$  in  $G$  corresponds to a sphere of  $\mathbf{P}$  of radius in  $[M^{-1}, M]$  and tangent to the unit sphere of  $\mathbb{R}^d$ . A similar argument shows that  $\mathbf{P}$  almost surely contains tangent spheres whose tangency graph contains  $G$ . Note that in the set  $\mathbf{P}$  new connections can occur (non tangent spheres in  $\tilde{P}_n$  can become tangent at the limit).

The first part of the proposition reduces to showing that  $\mathbf{C}$  almost surely has at most one accumulation point in  $\mathbb{R}^d$ . We argue by contradiction and we suppose that with probability bigger than  $\varepsilon$ , there exist two accumulation points  $A_1$  and  $A_2$  in  $\mathbf{C}$  such that  $|A_1 - A_2| \geq \varepsilon$  and  $|A_1|, |A_2| \leq \varepsilon^{-1}$ . This implies, by (4.2), that for any  $s \geq 0$  with a probability asymptotically bigger than  $\varepsilon$  the point 0 is  $(\varepsilon/2, s)$ -supported in  $\tilde{\mathbf{C}}_n$ . Which contradicts (4.1).  $\square$

Since every subgraph of a  $d$ -parabolic graph is itself  $d$ -parabolic (obvious from the definition), the following extension of [77, Theorem 3.1 (1)] together with the last proposition enables us to finish to proof of the Theorem 4.9.

**Theorem 4.12** ([22, Theorem 7]). *Let  $G$  be a graph of bounded degree. If  $G$  is packable in  $\mathbb{R}^d$  and if the packing has finitely many accumulation points in  $\mathbb{R}^d$ , then  $G$  is  $d$ -parabolic.*

**Remark 4.13.** *In order to be totally accurate, the  $d$ -parabolicity notion defined in [22] corresponds to the definitions of Section 4.2.2 when the function  $m$  is defined on the edges of the graph. But these two notions easily coincide in the bounded degree case.*

## 4.4 Geometric applications

### 4.4.1 Isoperimetric inequalities and alternative

If  $W$  is a subset of a graph  $G$ , we recall that  $\partial W$  is the set of vertices not in  $W$  but neighbor with some vertex in  $W$ . We begin with an isoperimetric consequence of  $d$ -parabolicity which is an extension of [77, Theorem 9.1(1)]. The proof is similar.

**Proposition 4.14.** *Let  $G = (V, E)$  be a locally finite, infinite, connected graph. Let  $o \in V$ , and  $g : \mathbb{R}_+ \rightarrow \mathbb{R}_+^*$  be some nondecreasing function.*

(1) *Suppose that  $G$  is  $d$ -parabolic. If for every finite set  $W$  containing  $o \in W$ , we have  $|\partial W| \geq g(|W|)$  then*

$$\sum_{n=1}^{\infty} g(n)^{-\frac{d}{d-1}} = \infty. \quad (4.3)$$

(2) *If  $g$  satisfies (4.3) and if  $|\partial W_k| \leq g(|W_k|)$ , for  $(W_k)_{k \geq 0}$  defined recursively by*

$$W_0 = \{o\} \text{ and } W_{k+1} = W_k \cup \partial W_k \text{ for } k \geq 0,$$

*then  $G$  is  $d$ -parabolic.*

*Démonstration.* We know by assumption that  $d\text{-VEL}(\Gamma(o)) = \infty$ . This implies that we can find functions  $m_i : V \rightarrow \mathbb{R}_+$  such that  $\|m_i\|_d = 2^{-i}$  and  $\inf_{\gamma \in \Gamma(o)} \text{Length}_{m_i}(\gamma) \geq 1$ . Hence  $m := \sum_{i=0}^{\infty} m_i$  defines a function on  $V$  such that

$$\|m\|_d \leq 1 \text{ and } \inf_{\gamma \in \Gamma(o)} \text{Length}_m(\gamma) = \infty.$$

Without loss of generality we will suppose that  $m(v) > 0$  for all vertices  $v \in V$ . The function  $m \in \mathbb{L}^d(V)$  defines a function  $V \times V \rightarrow \mathbb{R}_+$  by setting

$$d_m(v, v') := \inf\{\text{Length}_m(\gamma), \gamma : v \rightarrow v'\}.$$

The idea is to explore the graph  $G$  in a continuous manner according to  $d_m$  and to use the isoperimetric inequality provided by  $g$ . For each  $v \in V$  let

$$I_v := [d_m(o, v) - m(v), d_m(o, v)].$$

For  $h \in \mathbb{R}_+$ , we define  $s_v(h) := \frac{\text{Leb}(I_v \cap [0, h])}{m(v)}$ . Intuitively, water flows in the graph  $G$  starting from  $o$ ,  $m(v)$  is the time that water needs to wet  $v$  before flowing to its neighbors. A vertex  $v \in V$  begin to get wet at  $h = \min I_v$  and is completely wet at  $h = \max I_v$ . The function  $s_v(h)$  represents the percentage of water in  $v$ . We set  $s(h) := \sum_{v \in V} s_v(h)$ . Since  $d_m(o, \infty) = \infty$ , for every  $h \in \mathbb{R}_+$  there are only finitely many  $v \in V$  such that  $s_v(h) \neq 0$  and then  $s(h)$  is piecewise linear. We denote  $W_h := \{v \in V, h \geq \max I_v\}$  the set of vertices that are totally wet at time  $h$  and  $G_h := \{v \in V, d_m(o, v) - m(v) \leq h < d_m(o, v)\}$  the set of vertices that are getting wet at time  $h$ . Clearly  $G_h = \partial W_h$ . Let

$$f(x) = \min\left(g\left(\frac{x}{2}\right), \frac{x}{2}\right).$$

If  $|G_h| \geq s(h)/2$  then

$$|G_h| \geq f(s(h)), \tag{4.4}$$

otherwise  $|G_h| < s(h)/2$ , then the number of completely wet vertices is at least  $s(h)/2$  (because  $s_v(h) \leq 1$ ) and consequently  $|G_h| \geq g(s(h)/2)$ . Thus (4.4) always holds. At points where  $h \mapsto s(h)$  is differentiable we have

$$\frac{ds}{dh}(h) = \sum_{v \in G_h} s'_v(h) = \sum_{v \in G_h} \frac{1}{m(v)}.$$

Writing  $1 = m(v)^{(d-1)/d} m(v)^{-(d-1)/d}$  and using Hölder inequality with  $p = d$  we get

$$\left( \sum_{v \in G_h} 1 \right) \leq \left( \sum_{v \in G_h} \frac{1}{m(v)} \right)^{\frac{d-1}{d}} \left( \sum_{v \in G_h} m(v)^{d-1} \right)^{1/d},$$

and thus using (4.4) :

$$\frac{ds}{dh}(h) \geq \frac{|G_h|^{\frac{d}{d-1}}}{\left( \sum_{v \in G_h} m(v)^{d-1} \right)^{\frac{1}{d-1}}} \geq \frac{f(s(h))^{\frac{d}{d-1}}}{\left( \sum_{v \in G_h} m(v)^{d-1} \right)^{\frac{1}{d-1}}},$$

$$\text{therefore } \frac{ds}{f(s(h))^{\frac{d}{d-1}}} \geq \frac{dh}{\left( \sum_{v \in G_h} m(v)^{d-1} \right)^{\frac{1}{d-1}}}.$$

Integrating for  $0 < a < h < b < \infty$  and using Hölder with  $p = d$  we get

$$\int_{s(a)}^{s(b)} \frac{ds}{f(s)^{\frac{d}{d-1}}} \geq \int_a^b \frac{dh}{\left( \sum_{v \in G_h} m(v)^{d-1} \right)^{\frac{1}{d-1}}} \geq \frac{(b-a)^{d/(d-1)}}{\left( \int_a^b \left( \sum_{v \in G_h} m(v)^{d-1} \right) dh \right)^{1/(d-1)}}.$$

Remark that  $\int_0^\infty \left( \sum_{v \in G_h} m(v)^{d-1} \right) dh = \sum_{v \in V} m(v)^d < \infty$ , and that  $s(b) \rightarrow \infty$  when  $b \rightarrow \infty$ . We conclude that the integral of  $f(\cdot)^{-\frac{d}{d-1}}$  diverges and the same conclusion holds for  $g(\cdot)^{-\frac{d}{d-1}}$ . Since  $g(\cdot)$  is non-decreasing, a comparison series-integral ends the proof of the first part of the proposition.

For the second part, set  $n_k = |W_k|$  and define for  $N \in \mathbb{N}^*$  a function  $m : V \rightarrow \mathbb{R}_+$  on  $G$  by

$$m(v) = \begin{cases} g(n_k)^{-\frac{1}{d-1}} & \text{for } v \in \partial W_k \text{ and } k \leq N, \\ 0 & \text{otherwise.} \end{cases}$$

Then we have  $\inf\{\text{Length}_m(\gamma) : \gamma \in \Gamma(o)\} \geq \sum_{k=0}^N g(n_k)^{-\frac{1}{d-1}}$  and

$$\|m\|_d^d \leq \sum_{k=0}^N \frac{|\partial W_k|}{g(n_k)^{d/(d-1)}} \leq \sum_{k=0}^N g(n_k)^{-\frac{1}{d-1}}.$$



By definition of the extremal length, it suffices to show that  $\sum_{k=0}^{\infty} g(n_k)^{-\frac{1}{d-1}} = \infty$ . Note that  $n_{k+1} \leq n_k + g(n_k)$ , thus by monotonicity of  $g$ , we obtain

$$\frac{1}{g(n_k)^{\frac{1}{d-1}}} \geq \frac{1}{n_{k+1} - n_k} \sum_{n=n_k}^{n_{k+1}-1} \frac{1}{g(n)^{\frac{1}{d-1}}} \geq \sum_{n=n_k}^{n_{k+1}-1} \frac{1}{g(n_k)} \frac{1}{g(n)^{\frac{1}{d-1}}} \geq \sum_{n=n_k}^{n_{k+1}-1} \frac{1}{g(n)^{d/(d-1)}}.$$

Which implies  $\sum_{k=0}^{\infty} g(n_k)^{-\frac{1}{d-1}} \geq \sum_{n_0}^{\infty} g(n)^{-d/(d-1)} = \infty$ . □

Let us recall the definition of the Cheeger constant of a infinite graph  $G$  :

$$\text{Cheeger}(G) := \inf \left\{ \frac{|\partial W|}{|W|} : W \subset G, |W| < \infty \right\}.$$

The following corollary generalizes a theorem regarding planar graphs indicated by Gromov and proved by several authors. See Bowditch [35] for a very short proof and references for previous proofs.

**Corollary 4.15.** *Let  $G$  be an infinite locally finite connected graph which admits a  $M$ -uniform packing in  $\mathbb{R}^d$ . Then we have the following alternative :*

- either  $G$  has a positive Cheeger constant,
- or for any  $\varepsilon > 0$ , there are arbitrarily large subsets  $W$  of  $G$  such that

$$|\partial W| \leq |W|^{\frac{d-1}{d} + \varepsilon}.$$

*Démonstration.* Let  $G$  be a infinite connected graph which is the tangency graph of a  $M$ -uniform packing in  $\mathbb{R}^d$  (in particular  $G$  has bounded degree). If  $\text{Cheeger}(G) = 0$ , then we can find a sequence of subsets  $A_i \subset G$  such that

$$\frac{|\partial A_i|}{|A_i|} \xrightarrow{i \rightarrow \infty} 0.$$

Remark that the  $A_i$ 's are not necessarily connected subgraphs. For each  $i \geq 0$ , we pick a vertex  $o_i$  uniformly at random among the vertices of  $A_i$  and denote  $\mathcal{C}(o_i, A_i)$  the connected component of  $A_i$  connecting  $o_i$ . By a compactness argument (see the discussion before Definition 4.8) we deduce that along a subsequence we have the weak convergence for  $\Delta$

$$(\mathcal{C}(A_i, o_i), o_i) \xrightarrow{i \rightarrow \infty}^{(d)} (A, o),$$

where  $(A, o)$  is a random rooted graph. We assume that there is no need to pass to a subsequence. Therefore the sequence of rooted random graphs  $(\mathcal{C}(A_i, o_i), o_i)_{i \geq 1}$  satisfies all the hypotheses of Theorem 4.9, in particular  $(A, o)$  is almost surely  $d$ -parabolic. By Proposition 4.14, for any  $\delta, \varepsilon > 0$ , there exists a.s. a random subset  $W \subset A$  containing  $o$  and satisfying

$$|\partial W| \leq \delta |W|^{\frac{d-1}{d} + \varepsilon}.$$

In particular  $|W| \geq \delta^{-1/(\frac{d-1}{d}+\varepsilon)}$ . We claim that there exists an isomorphic copy of  $W$  and its boundary already contained in  $G$ . Indeed for any  $k \geq 0$ , the bounded degree assumption combined with the fact that  $\frac{|\partial A_i|}{|A_i|} \rightarrow 0$  imply that

$$\mathbb{P}(o_i \text{ is at a graph distance less than } k \text{ from } \partial A_i) \xrightarrow{i \rightarrow \infty} 0.$$

Hence, almost surely for any  $k \geq 0$ , the ball of radius  $k$  around  $o$  in  $A$  is a subgraph of some  $A_i$ 's and thus of  $G$ . This finishes the proof of the corollary.  $\square$

#### 4.4.2 Non existence of $M$ -uniform packing

As a consequence of the last corollary, the graph  $\mathbb{Z}^{d+1}$  cannot be  $M$ -uniform packed in  $\mathbb{R}^d$  for some  $M \geq 0$ . This is a weaker result compared to [22] where it is shown that  $\mathbb{Z}^{d+1}$  cannot be sphere packed in  $\mathbb{R}^d$  using non-existence of bounded non constant  $d$ -harmonic functions on  $\mathbb{Z}^d$ .

The *parabolic index* of a graph  $G$  (see [135]) is the infimum of all  $d \geq 0$  such that  $G$  is  $d$ -parabolic (with the convention that  $\inf \emptyset = \infty$ ). For example, Maeda [108] proved that the parabolic index of  $\mathbb{Z}^d$  is  $d$ . It is easy to see that the parabolic index of a regular tree is infinite, leading to the following consequence.

**Corollary 4.16.** *Let  $G_n$  be a deterministic sequence of finite graphs. If there exists  $f(n) \xrightarrow{n \rightarrow \infty} \infty$  and  $k \in \{2, 3, \dots\}$  such that*

$$\frac{\#\{v \in G_n, \text{Ball}_{G_n}(v, f(n)) = k\text{-regular tree up to level } f(n)\}}{|G_n|} \xrightarrow{n \rightarrow \infty} 1,$$

*then for all  $M \geq 0$ ,  $G_n$  eventually cannot be  $M$ -uniform packed in  $\mathbb{R}^d$ .*

*Démonstration.* Note that any unbiased weak limit of  $G_n$  is the  $k$ -regular tree and apply Theorem 4.9.  $\square$

That is, if for a sequence of  $k$ -regular graphs,  $k > 2$ , the girth grows to infinity then only finitely many of the graphs can be  $M$ -uniform packed in any fixed dimension. The same holds if the limit is some other nonamenable graph.

### 4.5 Open problems

Several necessary conditions are provided in this paper for a graph to be ( $M$ -uniform) packed in  $\mathbb{R}^d$ . The first two questions are related to existence of packable graphs in  $\mathbb{R}^d$ .

- Question 2.**
1. Find necessary and sufficient conditions for a graph to be ( $M$ -uniform) packable in  $\mathbb{R}^d$ .
  2. Exhibit a natural family of graphs which are ( $M$ -uniform) packable in  $\mathbb{R}^d$ .
  3. Show that the number of tetrahedrations in  $\mathbb{R}^3$  with  $n$  vertices grows to infinity.

**Question 3.** *It is of interest to understand what is the analogue of packing of a graph and the results above in the context of Riemannian manifolds. Is packable in the discrete context of graphs analogous to conformally flat?*

**Question 4.** *Show that the Cayley graph of Heisenberg group  $\mathbf{H}_3(\mathbb{Z})$  generated by*

$$A = \begin{pmatrix} 1 & 1 & 0 \\ 0 & 1 & 0 \\ 0 & 0 & 1 \end{pmatrix} \text{ and } B = \begin{pmatrix} 1 & 0 & 0 \\ 0 & 1 & 1 \\ 0 & 0 & 1 \end{pmatrix},$$

*is not packable in  $\mathbb{R}^d$  though is known to be 4-parabolic, see e.g. [133].*

The two following questions deal with the geometry of the accumulation points (of centers) of packing in  $\mathbb{R}^d$ .

**Question 5.** *Does there exist a graph  $G$  packable in  $\mathbb{R}^d$  in two manners  $P_1$  and  $P_2$  such that the set of accumulation points in  $\mathbb{R}^d \cup \{\infty\}$  for  $P_1$  is a point but not for  $P_2$ ?*

**Question 6** ([22]). *Show that any packing of  $\mathbb{Z}^3$  in  $\mathbb{R}^3$  has at most one accumulation point in  $\mathbb{R}^d \cup \{\infty\}$ .*

**Question 7** (Parabolicity for edges). *What is left of Theorem 4.9 in the context of edge parabolicity (where the function  $m$  of Section 4.2.2 is defined on the edges of the graph) without the bounded degree assumption? For instance, is it the case that every limit of unbiased random planar graphs is 2-edge-parabolic (which means SRW is recurrent)?*

**Question 8** (Diffusivity). *Let  $G$  be a  $d$ -parabolic graph. Consider  $(S_i)_{i \geq 0}$  a simple random walk on  $G$ . Do we have*

$$\liminf_{n \rightarrow \infty} \frac{d_{\text{gr}}(S_0, S_n)}{\sqrt{n}} < \infty \quad ?$$

**Question 9** (Mixing time). *Let  $G$  be a finite graph packable in  $\mathbb{R}^d$  with bounded degree. Show that mixing time is bigger than  $C_d \text{diameter}(G)^2$ . In particular the planar  $d = 2$  case is still open.*

**Acknowledgments :** Part of this work was done during visit of the second author to Weizmann Institute. The second author thanks his hosts for this visit. We are indebted to Steffen Rohde and to James T. Gill for pointing out several inaccuracies in a first version of this work. Thanks for the referee for a very useful report.

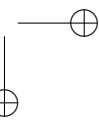
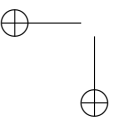
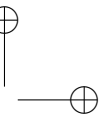
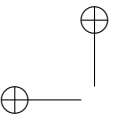

# Stationary Random Graphs

---

LES RÉSULTATS DE CE CHAPITRE ONT ÉTÉ OBTENUS EN COLLABORATION AVEC ITAI BENJAMINI ET ONT ÉTÉ SOUMIS POUR PUBLICATION.

A stationary random graph is a random rooted graph whose distribution is invariant under re-rooting along the simple random walk. We adapt the entropy technique developed for Cayley graphs and show in particular that stationary random graphs of subexponential growth are almost surely Liouville, that is, admit no non constant bounded harmonic function. Applications include the uniform infinite planar quadrangulation and long-range percolation clusters.

## 5.1 Introduction

A stationary random graph  $(G, \rho)$  is a random rooted graph whose distribution is invariant under re-rooting along a simple random walk started at the root  $\rho$  (see Section 5.1.1 for a precise definition). The entropy technique and characterization of the Liouville property for groups, homogeneous graphs or random walk in random environment [80, 81, 83, 84] are adapted to this context. In particular we have

**Theorem 5.1.** *Let  $(G, \rho)$  be a stationary random graph of subexponential growth in the sense that*

$$n^{-1} \mathbf{E} \left[ \log (\#B_G(\rho, n)) \right] \xrightarrow{n \rightarrow \infty} 0, \tag{5.1}$$

where  $\#B_G(\rho, n)$  is the number of vertices within distance  $n$  from the root  $\rho$ , then  $(G, \rho)$  is almost surely Liouville.

Recall that a function from the vertices of a graph to  $\mathbb{R}$  is harmonic if and only if the value of the function at a vertex is the average of the value over its neighbors, for all vertices of the graph. We call graphs admitting no non constant bounded harmonic functions *Liouville*. In the case of graphs of bounded degree, Corollary 5.13 characterizes stationary non-Liouville random graphs as those on which the simple random walk is *ballistic*.

The motivation of this work lies in the study of the Uniform Infinite Planar Quadrangulation (abbreviated by UIPQ) introduced in [89] (following the pioneer work of [11]). The UIPQ is a random infinite planar graph whose faces are all squares

which is stationary. This object is very natural and of special interest for understanding two dimensional quantum gravity and has triggered a lot of work, see e.g. [10, 11, 42, 49, 101, 111]. One of the fundamental questions regarding the UIPQ, is to prove recurrence or transience of simple random walk on this graph. Unfortunately, the degrees in the UIPQ are not bounded thus the techniques of [21] fail to apply. Nevertheless it has been conjectured in [11] that the UIPQ is a.s. recurrent. As an application of Theorem 5.1, we deduce a step in this direction,

**Corollary 5.2.** *The Uniform Infinite Planar Quadrangulation is almost surely Liouville.*

See also the very recent work of Steffen Rohde and James T. Gill [71] proving that the conformal type of the Riemann surface associated to the UIPQ is parabolic. Another application concerns a question of Berger [23] proving that certain long range percolation clusters are Liouville (see Section 5.2).

The notion of stationary random graph generalizes the concept of Cayley and transitive graph where the homogeneity of the graph is replaced by an invariant distribution along the simple random walk. This notion is very closely related to the ergodic theory notions of unimodular random graphs of [7] and measured equivalence relations see e.g. [82]. Roughly speaking, unimodular random graphs correspond, after biasing by the degree of the root, to stationary and *reversible* random graphs (see Definition 5.3). Using ideas from measured equivalence relations theory we are able to prove (Theorem 5.18) that if a stationary random graph of bounded degree  $(G, \rho)$  is non reversible then the simple random walk on  $G$  is ballistic, thus improving Theorem A of [122] and extending [134] in the case of transitive graphs.

In a forthcoming work, the authors also use the notion of stationary and unimodular random graph in order to show that the simple random walk on  $\mathbb{Z}^d$  indexed by  $T_\infty$ , the critical geometric Galton-Watson tree conditioned to survive [85], is recurrent if and only if  $d \leq 4$ .

The paper is organized as follows. The remaining of this section is devoted to a formal definition of stationary and reversible random graphs. Section 2 recalls the links between these concepts, unimodular random graphs and measured equivalence relations. The entropy technique is developed in Section 3. In Section 4 we explore under which conditions a stationary random graph is not reversible. The last section is devoted to applications and open problems. It also contains (Proposition 5.22) a construction of a stationary and reversible random graph of subexponential growth which is planar and transient.

**Acknowledgments :** We are grateful to Pierre Pansu, Frederic Paulin and Damien Gaboriau for many stimulating lessons on measured equivalence relations. We thank Russell Lyons for comments and enlightening discussions and Jean-François Le Gall for a careful reading of a first version of this paper. We are also indebted to Omer Angel for a discussion that led to Proposition 5.22.

### 5.1.1 Definitions

A graph  $G = (V(G), E(G))$  is a pair of sets,  $V(G)$  representing the set of vertices and  $E(G)$  the set of (unoriented) edges. In the following, all the graphs considered are countable, connected and locally finite. We also restrict ourself to *simple* graphs, that is, without loop nor multiple edge. Two vertices  $x, y \in V(G)$  linked by an edge are called *neighbors* in  $G$  and we write  $x \sim y$ . The *degree*  $\deg(x)$  of  $x$  is the number of neighbors of  $x$  in  $G$ . For any pair  $x, y \in G$ , the *graph distance*  $d_{\text{gr}}^G(x, y)$  is the minimal length of a path joining  $x$  and  $y$  in  $G$ . For every  $r \in \mathbb{Z}_+$ , the ball of radius  $r$  around  $x$  in  $G$  is the subgraph of  $G$  spanned by the vertices at distance less than or equal to  $r$  from  $x$  in  $G$ , it is denoted by  $B_G(x, r)$ .

A *rooted graph* is a pair  $(G, \rho)$  where  $\rho \in V(G)$  is called the root vertex. An isomorphism between two rooted graphs is a graph isomorphism that maps the roots of the graphs. Let  $\mathcal{G}_\bullet$  be the set of isomorphism classes of locally finite rooted graphs  $(G, \rho)$ , endowed with the distance  $d_{\text{loc}}$  defined by

$$d_{\text{loc}}((G_1, \rho_1), (G_2, \rho_2)) = \inf \left\{ \frac{1}{r+1} : r \geq 0 \text{ and } (B_{G_1}(\rho_1, r), \rho_1) \simeq (B_{G_2}(\rho_2, r), \rho_2) \right\},$$

where  $\simeq$  stands for the rooted graph equivalence. With this topology,  $\mathcal{G}_\bullet$  is a Polish space (see [21]). Similarly, we define  $\mathcal{G}_{\bullet\bullet}$  (resp.  $\vec{\mathcal{G}}$ ) be the set of isomorphism classes of bi-rooted graphs  $(G, x, y)$  that are graphs with two distinguished ordered points (resp. graphs  $(G, (x_n)_{n \geq 0})$  with an semi-infinite path), where the isomorphisms considered have to map the two distinguished points (resp. the path). These two sets are equipped with variants of the distance  $d_{\text{loc}}$  and are Polish with the induced topologies. Formally elements of  $\mathcal{G}_\bullet, \mathcal{G}_{\bullet\bullet}$  and  $\vec{\mathcal{G}}$  are equivalence classes of graphs, but we will not distinguish between graphs and their equivalence classes and we use the same terminology and notation. One way to bypass this identification is to choose once for all a canonical representant in each class, see [7, Section 2].

Let  $(G, \rho)$  be a rooted graph. For  $x \in V(G)$  we denote the law of the *simple random walk*  $(X_n)_{n \geq 0}$  on  $G$  starting from  $x$  by  $P_x^G$  and its expectation by  $E_x^G$ . It is easy to check that when  $(G, \rho)$  is an equivalence class of rooted graphs the distribution of  $(G, (X_n)_{n \geq 0}) \in \vec{\mathcal{G}}$  when  $(X_n)$  starts from  $\rho$  is well-defined. We speak of “the simple random walk of law  $P_\rho^G$  conditionally on  $(G, \rho)$ ”. It is easy to check that all the quantities we will use in the paper do not depend of a choice of a representative of  $(G, \rho)$ .

A random rooted graph  $(G, \rho)$  is a random variable taking values in  $\mathcal{G}_\bullet$ . In this work we will use  $\mathbf{P}$  and  $\mathbf{E}$  for the probability and expectation referring to the underlying random graph. If conditionally on  $(G, \rho)$ ,  $(X_n)_{n \geq 0}$  is the simple random walk started at  $\rho$ , we denote the distribution of  $(G, (X_n)_{n \geq 0}) \in \vec{\mathcal{G}}$  by  $\mathbb{P}$ , and the corresponding expectation by  $\mathbf{E}$ . The following concept is quite standard.

**Definition 5.3.** *Let  $(G, \rho)$  be a random rooted graph. Conditionally on  $(G, \rho)$ , let  $(X_n)_{n \geq 0}$  be the simple random walk on  $G$  starting from  $\rho$ . The graph  $(G, \rho)$  is called stationary if*

$$(G, \rho) = (G, X_n) \quad \text{in distribution, for all } n \geq 1, \tag{5.2}$$

or equivalently for  $n = 1$ . In words a stationary random graph is a random rooted graph whose distribution is invariant under re-rooting along a simple random walk on  $G$ . Furthermore,  $(G, \rho)$  is called reversible if

$$(G, X_0, X_1) = (G, X_1, X_0) \text{ in distribution.} \tag{5.3}$$

Clearly any reversible random graph is stationary.

**Example 5.1.** Any Cayley graph rooted at any vertex is stationary and reversible. Any transitive graph  $G$  (i.e. whose isomorphism group is transitive on  $V(G)$ ) is stationary. For examples of transitive graphs which are not reversible, see [18, Examples 3.1 and 3.2]. E.g. the “grandfather” graph (see Fig. below) is a transitive (hence stationary) graph which is not reversible.

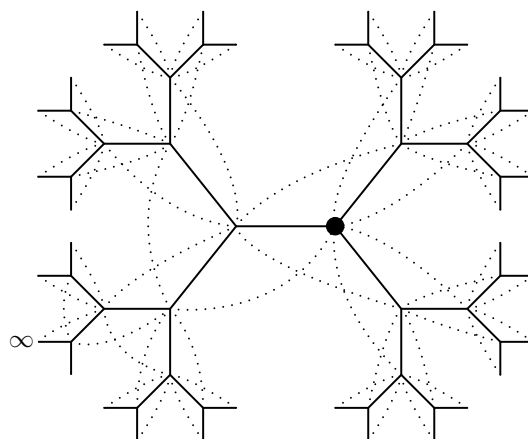

FIG. : The “grandfather” graph is obtained from the 3-regular tree by choosing a point at infinity that orientates the graph and adding all the edges from grand sons to grand-fathers.

**Example 5.2.** [21, Section 3.2] Let  $G$  be a finite connected graph. Pick a vertex  $\rho \in V(G)$  with a probability proportional to its degree (normalized by  $\sum_{u \in V(G)} \deg(u)$ ). Then  $(G, \rho)$  is a reversible random graph.

**Example 5.3** (Augmented Galton-Watson tree). Consider two independent Galton-Watson trees with offspring distribution  $(p_k)_{k \geq 0}$ . Link the root vertices of the two trees by an edge and root the obtained graph at the root of the first tree. The resulting random rooted graph is stationary and reversible, see [82, 106, 107].

## 5.2 Connections with other notions

As we will see, the concept of stationary random graph can be linked to various notions. In the context of bounded degree, stationary random graphs generalize unimodular random graphs [7]. Stationary random graphs are closely related to graphed equivalence relations with an harmonic measure, see [122]. We however think that the probabilistic Definition 5.3 is more natural for our applications.



### 5.2.1 Ergodic theory

We formulate the notion of stationary random graphs in terms of ergodic theory. We can define the *shift* operator  $\theta$  on  $\vec{\mathcal{G}}$  by  $\theta((G, (x_n)_{n \geq 0})) = (G, (x_{n+1})_{n \geq 0})$ , and the projection  $\pi : \vec{\mathcal{G}} \rightarrow \mathcal{G}_\bullet$  by  $\pi((G, (x_n)_{n \geq 0})) = (G, x_0)$ .

Recall from the last section that if  $\mathbf{P}$  is the law of  $(G, \rho)$  we write  $\mathbb{P}$  for the distribution of  $(G, (X_n)_{n \geq 0})$  where  $(X_n)_{n \geq 0}$  is the simple random walk on  $G$  starting at  $\rho$ . The following proposition is a straightforward translation of the notion of a stationary random graph into that of a  $\theta$ -invariant probability measure on  $\vec{\mathcal{G}}$ .

**Proposition 5.4.** *Let  $\mathbf{P}$  a probability measure on  $\mathcal{G}_\bullet$  and  $\mathbb{P}$  the associated probability measure on  $\vec{\mathcal{G}}$ . Then  $\mathbf{P}$  is stationary if and only if  $\mathbb{P}$  is invariant under  $\theta$ .*

As usual, we will say that  $\mathbb{P}$  (and by extension  $\mathbf{P}$  or directly  $(G, \rho)$ ) is ergodic if  $\mathbb{P}$  is ergodic for  $\theta$ . Proposition 5.4 enables us to use all the powerful machinery of ergodic theory in the context of stationary random graphs. For instance, the classical theorems on the range and speed of a random walk on a group are valid :

**Theorem 5.5.** *Let  $(G, \rho)$  be a stationary and ergodic random graph. Conditionally on  $(G, \rho)$  denote  $(X_n)_{n \geq 0}$  the simple random walk on  $G$  starting from  $\rho$ . Set  $R_n = \#\{X_0, \dots, X_n\}$  and  $D_n = d_{\text{gr}}^G(X_0, X_n)$  for the range and distance from the root of the random walk at time  $n$ . There exists a constant  $s \geq 0$  such that we have the following almost sure and  $\mathbb{L}^1$  convergences for  $\mathbb{P}$ ,*

$$\frac{R_n}{n} \xrightarrow[n \rightarrow \infty]{\text{a.s. } \mathbb{L}^1} \mathbb{P} \left( \bigcap_{i \geq 1} \{X_i \neq \rho\} \right), \tag{5.4}$$

$$\frac{D_n}{n} \xrightarrow[n \rightarrow \infty]{\text{a.s. } \mathbb{L}^1} s. \tag{5.5}$$

**Remark 5.6.** *In particular a stationary and ergodic random graph is transient if and only if the range of the simple random walk on it grows linearly.*

*Démonstration.* The two statements are straightforward adaptations of [54]. See also [7, Proposition 4.8]. □

### 5.2.2 Unimodular random graphs

The Mass-Transport Principle has been introduced by Häggström in [76] to study percolation and was further developed in [18]. A random rooted graph  $(G, \rho)$  obeys the *Mass-Transport principle* (abbreviated by MTP) if for every Borel positive function  $F : \mathcal{G}_{\bullet\bullet} \rightarrow \mathbb{R}_+$  we have

$$\mathbf{E} \left[ \sum_{x \in \mathcal{V}(G)} F(G, \rho, x) \right] = \mathbf{E} \left[ \sum_{x \in \mathcal{V}(G)} F(G, x, \rho) \right]. \tag{5.6}$$

The name comes from the interpretation of  $F$  as an amount of mass sent from  $\rho$  to  $x$  in  $G$  : the mean amount of mass that  $\rho$  receives is equal to the mean quantity it sends. The MTP holds for a great variety of random graphs, see [7] where the MTP is extensively studied.

**Definition 5.7.** [7, Definition 2.1] If  $(G, \rho)$  satisfies (5.6) it is called unimodular (See [7] for explanation of the terminology).

Let us explain the link between unimodular random graphs and reversible random graphs. Suppose that  $F : \mathcal{G}_{\bullet\bullet} \rightarrow \mathbb{R}_+$  is a Borel positive function such that

$$F(G, x, y) = F(G, x, y)\mathbf{1}_{x \sim y}. \tag{5.7}$$

Applying the MTP to a unimodular random graph  $(G, \rho)$  with the function  $F$  we get

$$\mathbf{E} \left[ \sum_{x \sim \rho} F(G, \rho, x) \right] = \mathbf{E} \left[ \sum_{x \sim \rho} F(G, x, \rho) \right],$$

or equivalently

$$\mathbf{E} \left[ \deg(\rho) \frac{1}{\deg(\rho)} \sum_{x \sim \rho} F(G, \rho, x) \right] = \mathbf{E} \left[ \deg(\rho) \frac{1}{\deg(\rho)} \sum_{x \sim \rho} F(G, x, \rho) \right].$$

In other words, if  $(\tilde{G}, \tilde{\rho})$  is distributed according to  $(G, \rho)$  biased by  $\deg(\rho)$  (assuming that  $\mathbf{E}[\deg(\rho)] < \infty$ ) and if conditionally on  $(\tilde{G}, \tilde{\rho})$ ,  $X_1$  is a one-step simple random walk starting on  $\tilde{\rho}$  in  $\tilde{G}$  then we have the following equality in distribution

$$(\tilde{G}, \tilde{\rho}, X_1) \stackrel{(d)}{=} (\tilde{G}, X_1, \tilde{\rho}). \tag{5.8}$$

The graph  $(\tilde{G}, \tilde{\rho})$  is thus reversible hence stationary. Reciprocally, if  $(\tilde{G}, \tilde{\rho})$  is reversible we deduce that the graph  $(G, \rho)$  obtained after biasing by  $\deg(\rho)^{-1}$  obeys the MTP with functions of the form  $F(G, x, y)\mathbf{1}_{x \sim y}$ . By [7, Proposition 2.2] this is sufficient to imply the full mass transport principle. Let us sum-up.

**Proposition 5.8.** *There is a correspondence between unimodular random graphs such that the expectation of the degree of the root is finite and reversible random graphs :*

$$(G, \rho) \text{ unimodular and } \mathbf{E}[\deg(\rho)] < \infty \begin{array}{c} \xrightarrow{\text{bias by } \deg(\rho)} \\ \xleftarrow{\text{bias by } \deg(\rho)^{-1}} \end{array} (G, \rho) \text{ reversible.}$$

### 5.2.3 Measured equivalence relations

In this section we recall the link between random graphs and measured graphed equivalence relations. This notion will not be used in the rest of the paper.

Let  $(B, \mu)$  be a standard Borel space with a probability measure  $\mu$  and let  $E \subset B^2$  be a symmetric Borel set. We denote the smallest equivalence relation containing  $E$  by  $\mathcal{R}$ . Under mild assumptions (see below) the triplet  $(B, \mu, E)$  is called a *measured graphed equivalence relation* (MGER). The set  $E$  induces a graph structure on  $B$  by setting  $x \sim y \in B$  if  $(x, y) \in E$  or  $(y, x) \in E$ . For  $x \in B$ , one can interpret the equivalence class of  $x$  as a graph with the edge set given by  $E$ , which we root at the point  $x$ . If  $x$  is sampled according to  $\mu$ , any measured graphed equivalence relation can be seen

as a random rooted graph.

Here are the mild conditions to require for  $(B, \mu, E)$  to be a measured graphed equivalence relation. We suppose that  $\mathcal{R} \subset B^2$  is Borel, that each equivalence class is at most countable and that the  $\mathcal{R}$ -saturated of any Borel set of  $\mu$  measure zero is still of  $\mu$  measure zero. We also assume that the applications  $o : (x, y) \in E \mapsto x \in B$  and  $r : (x, y) \in E \mapsto (y, x) \in E$  are Borel and that  $\#o^{-1}(x)$  is finite for  $\mu$ -almost every  $x$ . We can define a probability measure  $\nu$  on  $E$  by  $\nu(f) = \int_B d\mu(x) \frac{1}{\#o^{-1}(x)} \sum_{x \sim y} f((x, y))$ . If  $\nu$  and its push-forward  $r_*\nu$  by  $r$  are mutually absolutely continuous then the triple  $(B, \mu, E)$  is called a *measured graphed equivalence relation*.

Reciprocally, the set  $\mathcal{G}_\bullet$  can be equipped with a symmetric Borel set  $E$  where  $((G, \rho), (G', \rho')) \in E$  if  $(G, \rho)$  and  $(G', \rho')$  represent the same isomorphism class of non-rooted graphs but are rooted at two different neighboring vertices. Denote  $\mathcal{R}$  the smallest equivalence relation on  $\mathcal{G}_\bullet$  that contains  $E$ . Thus a random rooted graph  $(G, \rho)$  of distribution  $\mathbf{P}$  gives rise to  $(\mathcal{G}_\bullet, \mathbf{P}, E)$  which, under mild assumptions on  $(G, \rho)$  is a MGER.

Remark however that the measured graphed equivalence relation we obtain with this procedure can have a graph structure on equivalence classes very different from the graph  $(G, \rho)$ . Consider for example the (random) graph  $\mathbb{Z}^2$  rooted at  $(0, 0)$ . Since  $\mathbb{Z}^2$  is a transitive graph, the measure obtained on  $\mathcal{G}_\bullet$  by the above procedure is concentrated on the singleton corresponding to the isomorphism class of  $(\mathbb{Z}^2, (0, 0))$ . Hence the random graph associated to this MGER is the rooted graph with one point, which is quite different from  $\mathbb{Z}^2$ !

There are two ways to bypass this difficulty : considering *rigid* graphs (that are graphs without non trivial isomorphisms see [82, Section 1E]) or add independent uniform labels  $\in [0, 1]$  on the graphs (see [7, Example 9.9]). Both procedures yield a MGER whose graph structure is that of  $(G, \rho)$ .

In particular we have the following dictionary between the notions of harmonic MGER [122, Definition 1.11], totally invariant MGER [122, Definition 1.12], measure preserving MGER [70, Section 8] or [7, Example 9.9] and the corresponding analogous for random rooted graphs.

measured graphed equivalence relation	random rooted graph
harmonic	stationary
totally invariant	reversible
measure preserving	unimodular

### 5.3 The Liouville property

In this section, we extend a well-known result on groups first proved in [13] relating Poisson boundary to entropy of a group. Here we adapt the proof which was given in [83, Theorem 1] in the case of groups (see also [84] in the case of homogeneous graphs). We basically follow the argument of [83] using *expectation* of entropy. The stationarity of the underlying random graph together with the Markov property of the simple random walk will replace homogeneity of the graph. We introduce the *mean entropy* of the

random walk and prove some useful lemmas. Then we derive the main results of this section.

In the following  $(G, \rho)$  is a stationary random graph. Recall that conditionally on  $(G, \rho)$ ,  $\mathbf{P}_x^G$  is the law of the simple random walk  $(X_n)_{n \geq 0}$  on  $G$  starting from  $x \in V(G)$ . For every integer  $0 \leq a \leq b < +\infty$ , the *entropy* of the simple random walk started at  $x \in V(G)$  between times  $a$  and  $b$  is

$$H_a^b(G, x) = \sum_{x_a, x_{a+1}, \dots, x_b} \varphi \left( \mathbf{P}_x^G(X_a = x_a, \dots, X_b = x_b) \right),$$

where  $\varphi(t) = -t \log(t)$ . To simplify notation we write  $H_a(G, x) = H_a^a(G, x)$ . Recalling that  $(G, \rho)$  is a random graph we set

$$h_a^b = \mathbf{E} \left[ H_a^b(G, \rho) \right] \text{ and } h_a = \mathbf{E} [H_a(G, \rho)].$$

**Proposition 5.9.** *If  $(G, \rho)$  is a stationary random graph then  $(h_n)_{n \geq 0}$  is a subadditive sequence.*

*Démonstration.* Let  $n, m \geq 0$ . We have

$$H_{n+m}(G, \rho) = \sum_{x_{n+m}} \varphi \left( \mathbf{P}_\rho^G(X_{n+m} = x_{n+m}) \right).$$

Applying the Markov property at time  $n$ , we get

$$H_{n+m}(G, \rho) = \sum_{x_{n+m}} \varphi \left( \sum_{x_n} \mathbf{P}_\rho^G(X_n = x_n) \mathbf{P}_{x_n}^G(X_m = x_{n+m}) \right).$$

Since  $\varphi$  is concave and  $\varphi(0) = 0$  we have  $\varphi(x + y) \leq \varphi(x) + \varphi(y)$ , for every  $x, y \geq 0$ . Hence we obtain

$$\begin{aligned} H_{n+m}(G, \rho) &\leq \sum_{x_{n+m}} \sum_{x_n} \varphi \left( \mathbf{P}_\rho^G(X_n = x_n) \mathbf{P}_{x_n}^G(X_m = x_{n+m}) \right) \\ &= H_n(G, \rho) + \sum_{x_n} \mathbf{P}_\rho^G(X_n = x_n) H_m(G, x_n). \end{aligned}$$

Taking expectations one has using (5.2)

$$\begin{aligned} h_{n+m} &\leq h_n + \mathbf{E} \left[ \sum_{x_n} \mathbf{P}_\rho^G(X_n = x_n) H_m(G, x_n) \right] \\ &= h_n + \mathbf{E} [H_m(G, X_n)] = h_n + h_m. \end{aligned}$$

□

The subadditive lemma then implies that

$$\frac{h_n}{n} \xrightarrow{n \rightarrow \infty} h \geq 0. \tag{5.9}$$

This limit is called the *mean entropy* of the stationary random graph  $(G, \rho)$ . It plays the role of the (deterministic) entropy of a random walk on a group. The following theorem generalizes the well-known connection between Liouville property and entropy.

**Theorem 5.10.** *Let  $(G, \rho)$  be a stationary random graph. The following conditions are equivalent :*

- the tail  $\sigma$ -algebra associated to the simple random walk on  $G$  started from  $\rho$  is almost surely trivial (in particular  $(G, \rho)$  is almost surely Liouville),
- the mean entropy  $h$  of  $(G, \rho)$  is null.

Before doing the proof, we start with a few lemmas.

**Lemma 5.11.** *For every  $0 \leq a \leq b < \infty$  we have  $h_a^b = h_a + (b - a)h_1$ . In particular for  $k \geq 1$  we have  $h_1^k = kh_1$ .*

*Démonstration.* Let  $0 \leq a \leq b < \infty$ . An application of the Markov property at time  $a$  leads to

$$\begin{aligned} H_a^b(G, \rho) &= - \sum_{x_a, \dots, x_b} P_\rho^G(X_a = x_a, \dots, X_b = x_b) \log \left( P_\rho^G(X_a = x_a, \dots, X_b = x_b) \right) \\ &= - \sum_{x_a} P_\rho^G(X_a = x_a) \log \left( P_\rho^G(X_a = x_a) \right) + \sum_{x_a} P_\rho^G(X_a = x_a) H_1^{b-a}(G, x_a). \end{aligned}$$

Taking expectations we get  $h_a^b = h_a + h_1^{b-a}$ . An iteration of the argument proves the lemma.  $\square$

If  $(G, \rho)$  is fixed and  $(X_n)_{n \geq 0}$  is distributed according to  $P_\rho^G$ , we denote

$$\begin{aligned} \mathcal{F}_n(G, \rho) &= \sigma(X_1, \dots, X_n), \\ \mathcal{F}^n(G, \rho) &= \sigma(X_n, \dots), \\ \mathcal{F}^\infty(G, \rho) &= \bigcap_{n \geq 0} \mathcal{F}^n(G, \rho). \end{aligned}$$

The last  $\sigma$ -algebra consists of tail events. By classical results of entropy theory, for all  $k \geq 0$ , the conditional entropy  $H(\mathcal{F}_k(G, \rho) \mid \mathcal{F}^n(G, \rho))$  increases as  $n \rightarrow \infty$  and converges to  $H(\mathcal{F}_k(G, \rho) \mid \mathcal{F}^\infty(G, \rho))$ . Furthermore, we have

$$H(\mathcal{F}_k(G, \rho) \mid \mathcal{F}^\infty(G, \rho)) \leq H(\mathcal{F}_k(G, \rho)),$$

with equality if and only if  $\mathcal{F}_k(G, \rho)$  and  $\mathcal{F}^\infty(G, \rho)$  are independent.

**Lemma 5.12.** *For  $1 \leq k \leq n \leq m < +\infty$  we have  $\mathbf{E}[H(X_1, \dots, X_k \mid X_n, \dots, X_m)] = kh_1 + h_{n-k} - h_n$ .*

*Démonstration.* We have by definition

$$\begin{aligned} &H(X_1, \dots, X_k \mid X_n, \dots, X_m) \\ &= - \sum_{\substack{x_1, \dots, x_k \\ x_n, \dots, x_m}} P_\rho^G(X_i = x_i, 1 \leq i \leq k \text{ and } n \leq i \leq m) \\ &\quad \times \log \left( \frac{P_\rho^G(X_i = x_i, 1 \leq i \leq k \text{ and } n \leq i \leq m)}{P_\rho^G(X_i = x_i, n \leq i \leq m)} \right). \end{aligned}$$

Applying the Markov property at time  $k$  one gets

$$= H_1^k(G, \rho) - H_n^m(G, \rho) + \sum_{x_k} P_\rho^G(X_k = x_k) H_{n-k}^{m-k}(G, x_k),$$

and taking expectations using (5.2), the right-hand side becomes  $h_1^k - h_n^m + h_{n-k}^{m-k}$ . An application of Lemma 5.11 completes the proof.  $\square$

In particular we see that the expected value of  $H(X_1, \dots, X_k \mid X_n, \dots, X_m)$  does not depend upon  $m$  (this is also true without taking expectation and follows from Markov property at time  $n$ ). If we let  $m \rightarrow \infty$  in the statement of the last lemma, we get by monotonicity of conditional entropy and monotone convergence

$$\mathbf{E}[H(\mathcal{F}_k(G, \rho) \mid \mathcal{F}^n(G, \rho))] = kh_1 + h_{n-k} - h_n. \tag{5.10}$$

*Proof of Theorem 5.10.* Using again the monotonicity of conditional entropy

$$H(\mathcal{F}_1(G, \rho) \mid \mathcal{F}^n(G, \rho)) \leq H(\mathcal{F}_1(G, \rho) \mid \mathcal{F}^{n+1}(G, \rho))$$

and the equality (9.6.2) for  $k = 1$ , we deduce that  $(h_{n+1} - h_n)_{n \geq 0}$  is decreasing and converges towards  $\tilde{h} \geq 0$ . By (5.9) and Cesaro’s Theorem, we deduce that  $\tilde{h} = h$ . Thus letting  $n \rightarrow \infty$  in (9.6.2) we get by monotone convergence

$$\mathbf{E}[H(\mathcal{F}_k(G, \rho) \mid \mathcal{F}^\infty(G, \rho))] = k(h_1 - h).$$

Comparing the last display with Lemma 5.11 (note that  $H(\mathcal{F}_k(G, \rho)) = H_1^k(G, \rho)$ ), it follows that  $h = 0$  if and only if almost surely, for all  $k \geq 0$ ,  $\mathcal{F}^\infty(G, \rho)$  is independent of  $\mathcal{F}_k(G, \rho)$ . In this case the classical Kolmogorov’s 0 – 1 law implies that  $\mathcal{F}^\infty(G, \rho)$  is almost surely trivial, in particular  $(G, \rho)$  is Liouville. This completes the proof of Theorem 5.10.  $\square$

*Proof of Theorem 5.1.* Let  $(G, \rho)$  be a stationary random graph of *subexponential growth* that is  $\mathbf{E}[\log(\#B_G(\rho, n))] = o(n)$ , as  $n \rightarrow \infty$ . Thanks to Theorem 5.10, we only have to prove that the mean entropy of  $G$  is zero. But by a classical inequality we have  $H_n(G, \rho) \leq \log(\#B_G(\rho, n))$ , taking expectations and using (5.9) yield the result.  $\square$

In the preceding theorem we saw that subexponential growth plays a crucial role. In the case of transitive or Cayley graphs, all the graphs considered have at most an exponential growth. But that there are stationary graphs with superexponential growth, here is an example.

**Example 5.4.** Let  $(G, \rho)$  be an augmented Galton-Watson tree (see Example 5.3) with offspringing distribution  $(p_k)_{k \geq 1}$  such that  $\sum_{k \geq 1} kp_k = \infty$ . We have

$$\liminf_{n \rightarrow \infty} \frac{\mathbf{E}[\log(B_G(\rho, n))]}{n} = \infty.$$

**Corollary 5.13.** *Let  $(G, \rho)$  be a stationary and ergodic random graph of degree almost surely bounded by  $M > 0$ . Conditionally on  $(G, \rho)$ , let  $(X_n)_{n \geq 0}$  be the simple random walk on  $G$  starting from  $\rho$ . We denote the speed of the random walk by  $s$  and the exponential volume growth of  $G$  by  $v$ , namely*

$$\begin{aligned} s &= \limsup_{n \rightarrow \infty} n^{-1} \mathbf{E} \left[ d_{\text{gr}}^G(X_0, X_n) \right], \\ v &= \limsup_{n \rightarrow \infty} n^{-1} \mathbf{E} \left[ \log(\#B_G(\rho, n)) \right]. \end{aligned}$$

Then the mean entropy  $h$  of  $(G, \rho)$  satisfies

$$\frac{s^2}{2} \leq h \leq vs.$$

In particular  $h = 0 \iff s = 0$  and if  $s$  or  $v$  is null then  $(G, \rho)$  is almost surely Liouville.

**Remark 5.14.** *This is an extension of the “fundamental inequality” for groups [145, Theorem 1], see also [84, Theorem 5.3.] for homogeneous graphs.*

*Démonstration.* Since  $(G, \rho)$  is ergodic, we know from Theorem 5.5(5.5) that  $n^{-1} d_{\text{gr}}^G(X_0, X_n)$  converges almost surely and in  $\mathbb{L}^1(\mathbb{P})$  towards  $s \geq 0$ . In particular if  $s > 0$ , for every  $\varepsilon \in ]0, s[$  we have

$$\mathbb{P}((s - \varepsilon)n \leq d_{\text{gr}}^G(X_0, X_n) \leq (s + \varepsilon)n) \xrightarrow{n \rightarrow \infty} 1. \quad (5.11)$$

*Lower bound.* We suppose  $s > 0$  otherwise the lower bound is trivial. We have

$$\begin{aligned} H_n(G, \rho) &\geq \sum_{\substack{x_n \\ d_{\text{gr}}^G(\rho, x_n) \geq (s - \varepsilon)n}} \varphi(\mathbb{P}_\rho^G(X_n = x_n)) \\ &= - \sum_{\substack{x_n \\ d_{\text{gr}}^G(\rho, x_n) \geq (s - \varepsilon)n}} \mathbb{P}_\rho^G(X_n = x_n) \log \left( \mathbb{P}_\rho^G(X_n = x_n) \right) \end{aligned}$$

At this point we use the Varopoulos-Carne estimates (see [107, Theorem 12.1]), for the probability inside the logarithm. Hence,

$$\begin{aligned} H_n(G, \rho) &\geq - \sum_{\substack{x_n \\ d_{\text{gr}}^G(\rho, x_n) \geq (s - \varepsilon)n}} \mathbb{P}_\rho^G(X_n = x_n) \log \left( 2\sqrt{M} \exp \left( -\frac{(s - \varepsilon)^2 n}{2} \right) \right) \\ &= \log \left( 2\sqrt{M} \exp \left( -\frac{(s - \varepsilon)^2 n}{2} \right) \right) \mathbb{P}_\rho^G(d_{\text{gr}}^G(X_0, X_n) \geq (s - \varepsilon)n). \quad (5.12) \end{aligned}$$

Now, we take expectation with respect to  $\mathbf{E}$ , divide by  $n$  and let  $n \rightarrow \infty$ . Using (5.11) and (5.9) we have  $h \geq \frac{(s - \varepsilon)^2}{2}$ .

*Upper bound.* Fix  $\varepsilon > 0$ . To simplify notation, we write  $B_s$  for  $B_G(\rho, (s + \varepsilon)n)$  and  $B_s^c$  for  $B_G(\rho, n) \setminus B_G(\rho, (s + \varepsilon)n)$ . We decompose the entropy  $H_n(G, \rho)$  as follows

$$\begin{aligned} H_n(G, \rho) &= \sum_{x_n \in B_s} \varphi(\mathbb{P}_\rho^G(X_n = x_n)) + \sum_{x_n \in B_s^c} \varphi(\mathbb{P}_\rho^G(X_n = x_n)) \\ &\leq \left( \sum_{x_n \in B_s} \mathbb{P}_\rho^G(X_n = x_n) \right) \log \left( \frac{\#B_s}{\sum_{x_n \in B_s} \mathbb{P}_\rho^G(X_n = x_n)} \right) \\ &\quad + \left( \sum_{x_n \in B_s^c} \mathbb{P}_\rho^G(X_n = x_n) \right) \log \left( \frac{\#(B_s^c)}{\sum_{x_n \in B_s^c} \mathbb{P}_\rho^G(X_n = x_n)} \right). \end{aligned}$$

We used the concavity of  $\varphi$  for the inequalities on the sums of the right-hand side. Using the uniform bound on the degree, we get the crude upper bound  $\#(B_s^c) \leq \#B_G(\rho, n) \leq M^n$ . Taking expectation we obtain (using the easy fact that for  $x \in [0, 1]$  one has  $-x \log(x) \leq e^{-1}$ )

$$h_n \leq 2e^{-1} + \mathbf{E} [\log(\#B_G(\rho, (s + \varepsilon)n))] + \mathbb{P} \left( d_{\text{gr}}^G(X_0, X_n) \geq (s + \varepsilon)n \right) n \log(M).$$

Divide the last quantities by  $n$  and let  $n \rightarrow \infty$ , then (5.9) and (5.11) show that  $h \leq (s + \varepsilon)v$ .  $\square$

## 5.4 The Radon-Nikodym Cocycle

In this part we borrow and reinterpret in probabilistic terms a notion coming from the measured equivalence relation theory, the Radon-Nikodym cocycle, in order to deduce several properties of stationary non reversible graphs, (see e.g. [82] for another application). This notion will play the role of the modular function in transitive graphs, see [134]. In the remaining of this section,  $(G, \rho)$  is a stationary random graph whose degree is almost surely bounded by a constant  $M > 0$ .

Conditionally on  $(G, \rho)$  of law  $\mathbf{P}$ , let  $(X_n)_{n \geq 0}$  be a simple random walk of law  $\mathbb{P}_\rho^G$ . Let  $\mu_{\rightarrow}$  and  $\mu_{\leftarrow}$  be the two probability measures on  $\mathcal{G}_{\bullet\bullet}$  such that  $\mu_{\rightarrow}$  is the law of  $(G, X_0, X_1)$  and  $\mu_{\leftarrow}$  that of  $(G, X_1, X_0)$ . It is easy to see that the two probability measures  $\mu_{\rightarrow}$  and  $\mu_{\leftarrow}$  are mutually absolutely continuous. To be precise, for any Borel set  $A \subset \mathcal{G}_{\bullet\bullet}$ , we have

$$\begin{aligned} \mathbb{P}((G, X_0, X_1) \in A) &= \mathbb{P}((G, X_1, X_2) \in A) \\ &\geq \mathbb{P}((G, X_1, X_0) \in A, X_2 = X_0) \\ &\geq M^{-1} \mathbb{P}((G, X_1, X_0) \in A). \end{aligned}$$

We used the stationarity for the first equation. Thus the Radon-Nikodym derivative of  $(G, X_1, X_0)$  with respect to  $(G, X_0, X_1)$ , given for any  $(g, x, y) \in \mathcal{G}_{\bullet\bullet}$  such that  $x \sim y$  by

$$\Delta(g, x, y) := \frac{d\mu_{\leftarrow}}{d\mu_{\rightarrow}}(g, x, y),$$



can be chosen such that

$$M^{-1} \leq \Delta(g, x, y) \leq M. \tag{5.13}$$

Note that the function  $\Delta$  is defined up to a set of  $\mu_{\rightarrow}$ -measure zero, and in the following we fix an arbitrary representative satisfying (5.13) and we keep the notation  $\Delta$  for this function. Since  $\Delta$  is a Radon-Nikodym derivative we obviously have  $\mathbb{E}[\Delta(G, X_0, X_1)] = 1$  and Jensen’s inequality yields

$$\mathbb{E}[\log(\Delta(G, X_0, X_1))] \leq 0, \tag{5.14}$$

with equality if and only if  $\Delta(G, X_0, X_1) = 1$  almost surely. In this latter case the two random variables  $(G, X_0, X_1)$  and  $(G, X_1, X_0)$  have the same law, that is  $(G, \rho)$  is reversible.

**Lemma 5.15.** *With the above notation, let  $A$  be a Borel subset of  $\mathcal{G}_{\bullet\bullet}$  of  $\mu_{\rightarrow}$ -measure zero. Then for  $\mathbf{P}$ -almost every rooted graph  $(g, \rho)$  and every  $x, y \in V(g)$  such that  $x \sim y$  we have  $(g, x, y) \notin A$ .*

*Démonstration.* By stationarity, for any  $n \geq 0$  the variable  $(G, X_n, X_{n+1})$  has the same distribution as  $(G, X_0, X_1)$ . Thus we have

$$\begin{aligned} 0 &= \sum_{n \geq 0} \mathbb{P}((G, X_n, X_{n+1}) \in A) = \mathbb{E} \left[ \sum_{n \geq 0} \mathbf{1}_{(G, X_n, X_{n+1}) \in A} \right] \\ &= \mathbf{E} \left[ \sum_{x \sim y \in G} \mathbf{1}_{(G, x, y) \in A} \left( \sum_{n \geq 0} \mathbb{P}_{\rho}^G(X_n = x, X_{n+1} = y) \right) \right]. \end{aligned}$$

Let  $x \sim y$  in  $G$ . Since  $G$  is connected, there exists values of  $n$  such that the probability that  $X_n = x$  and  $X_{n+1} = y$  is positive. Thus the sum between parentheses in the last display is positive. This proves the lemma.  $\square$

Note that the function  $(g, x, y) \rightarrow \Delta(g, y, x)$  is also a version of the Radon-Nikodym derivative  $\frac{d\mu_{\leftarrow}}{d\mu_{\rightarrow}}$ , hence we have  $\Delta(g, x, y) = \Delta(g, y, x)^{-1}$  for  $\mu_{\rightarrow}$ -almost every bi-rooted graphs in  $\mathcal{G}_{\bullet\bullet}$ . By the above lemma we also have  $\Delta(g, x, y) = \Delta(g, y, x)^{-1}$  for  $\mathbf{P}$ -almost every rooted graph  $(g, \rho)$  and every vertices  $x, y \in V(g)$  such that  $x \sim y$ .

**Lemma 5.16.** *For  $\mathbf{P}$ -almost every  $(g, \rho)$ , and every cycle  $\rho = x_0 \sim x_1 \sim \dots \sim x_n = \rho$  in  $g$  we have*

$$\prod_{i=0}^{n-1} \Delta(g, x_i, x_{i+1}) = 1. \tag{5.15}$$

*Démonstration.* In the measured equivalence relation theory this proposition is known as the cocycle property of the so-called Radon-Nikodym derivative of the equivalence relation, see [122, Lemme 1.16]. However we give a probabilistic proof of this fact. By a standard calculation on the simple random walk, conditionally on  $(G, \rho)$  and on

$\{\rho = X_0 = X_n\}$ , the path  $(X_0, X_1, \dots, X_{n-1}, X_n)$  has the same distribution as the reversed one  $(X_n, X_{n-1}, \dots, X_1, X_0)$ . In other words, for any positive Borel function  $F : \mathbb{R}_+ \rightarrow \mathbb{R}_+$  we have

$$\begin{aligned} \mathbb{E} \left[ F \left( \prod_{i=0}^{n-1} \Delta(G, X_i, X_{i+1}) \right) \mathbf{1}_{X_n=X_0} \right] &= \mathbb{E} \left[ F \left( \prod_{i=0}^{n-1} \Delta(G, X_{i+1}, X_i) \right) \mathbf{1}_{X_n=X_0} \right] \\ &= \mathbb{E} \left[ F \left( \prod_{i=0}^{n-1} \Delta(G, X_i, X_{i+1})^{-1} \right) \mathbf{1}_{X_n=X_0} \right]. \end{aligned}$$

Where we used the fact that for  $\mathbf{P}$ -almost every  $(g, \rho)$  and for any neighboring vertices  $x, y \in V(g)$ , we have  $\Delta(g, x, y) = \Delta(g, y, x)^{-1}$ . Since for every  $(g, \rho) \in \mathcal{G}_\bullet$  and any cycle  $\rho = x_0 \sim x_1 \sim \dots \sim x_n = \rho$  we have  $P_\rho^G(X_0 = x_0, X_1 = x_1, \dots, X_n = x_n) > 0$  the desired result easily follows.  $\square$

Suppose that the above Lemma holds, then we can extend the definition of  $\Delta$  to an arbitrary (isomorphism class of) bi-rooted graph  $(g, x, y)$  without assuming  $x \sim y$  (compared with [122, Proof of Théorème 1.15]). If  $x, y \in g$ , let  $x = x_0 \sim x_1 \sim \dots \sim x_n = y$  be a path in  $g$  between  $x$  and  $y$ , and set

$$\Delta(g, x, y) := \prod_{i=0}^{n-1} \Delta(g, x_i, x_{i+1}), \tag{5.16}$$

and by convention  $\Delta(g, x, x) = 1$ . This definition does not depend on the path chosen from  $x$  to  $y$  by the last lemma and is well founded for  $\mathbf{P}$ -almost every graph  $(g, \rho)$  and every  $x, y \in V(g)$ . We can now rephrase Theorem 1.15 of [122].

**Theorem 5.17** ([122]). *Let  $(G, \rho)$  be a stationary ergodic random graph. Assume that  $(G, \rho)$  is not reversible. Then almost surely the function*

$$x \in V(G) \mapsto \Delta(G, \rho, x),$$

*is positive harmonic and non constant.*

*Démonstration.* We follow the proof of [122]. By the stationarity of  $(G, \rho)$ , for any Borel function  $F : \mathcal{G}_\bullet \rightarrow \mathbb{R}_+$  we have

$$\mathbb{E} [F(G, X_0)] = \mathbb{E} [F(G, X_1)] = \mathbb{E} [F(G, X_0)\Delta(G, X_0, X_1)].$$

We thus get  $\deg(\rho)^{-1} \sum_{\rho \sim x} \Delta(G, \rho, x) = 1$  almost surely. It follows from Lemma 5.15, that almost surely, for any  $x \in V(G)$  we have

$$\frac{1}{\deg(x)} \sum_{x \sim y} \Delta(G, x, y) = 1.$$

One gets from the previous display and the definition of  $\Delta$ , that  $x \mapsto \Delta(G, \rho, x)$  is almost surely harmonic. By ergodicity if  $x \mapsto \Delta(G, \rho, x)$  has a positive probability to be constant then it is almost surely constant, and this constant equals 1. This case is excluded because  $(G, \rho)$  is not reversible.  $\square$

**Theorem 5.18.** *Let  $(G, \rho)$  be a stationary and ergodic random graph of degree almost surely bounded by  $M > 0$ . If  $(G, \rho)$  is non reversible, then the speed  $s$  (see (5.5)) of the simple random walk on  $(G, \rho)$  is positive.*

*Démonstration.* We consider the random process  $(\log(\Delta(G, X_0, X_n)))_{n \geq 0}$ . By Proposition 5.16 we almost surely have for all  $n \geq 0$

$$\log(\Delta(G, X_0, X_n)) = \sum_{i=0}^{n-1} \log(\Delta(G, X_i, X_{i+1})). \quad (5.17)$$

By (5.13) we have  $\mathbb{E}[|\log(\Delta(G, X_0, X_1))|] < \infty$  and the ergodic theorem implies the following almost sure and  $\mathbb{L}^1$  convergence with respect to  $\mathbb{P}$

$$\frac{\log(\Delta(G, X_0, X_n))}{n} \xrightarrow[n \rightarrow \infty]{} \mathbb{E}[\log(\Delta(G, X_0, X_1))]. \quad (5.18)$$

By computing  $\Delta(G, X_0, X_n)$  as in (5.16) along a geodesic path from  $X_0$  to  $X_n$  in  $G$  and using (5.13) we deduce that a.s. for every  $n \geq 0$

$$|\log(\Delta(G, X_0, X_n))| \leq \log(M) d_{\text{gr}}^G(X_0, X_n).$$

If  $(G, \rho)$  is not reversible, we already noticed that the inequality (5.14) is strict. Thus combining (5.5), (5.18) and the last display we get  $s \geq |\mathbb{E}[\log(\Delta(G, X_0, X_1))]| \log(M)^{-1}$  which is strictly positive. This is the desired result.  $\square$

**Remark 5.19.** *By Corollary 5.13, subexponential growth in the sense of (5.1) implies  $s = 0$  for stationary and ergodic random graphs of bounded degree, so in particular such random graphs are reversible. This fact also holds without the bounded degree assumption (Russell Lyons, personal communication).*

## 5.5 Applications

### 5.5.1 The Uniform planar quadrangulation

A planar map is an embedding of a planar graph into the two-dimensional sphere seen up to continuous deformations. A quadrangulation is a planar map whose faces all have degree four. The Uniform Infinite Planar Quadrangulation (UIPQ) introduced by Krikun in [89] is the weak local limit (in a sense related to  $d_{\text{loc}}$ ) of uniform quadrangulations with  $n$  faces with a distinguished oriented edge (see Angel and Schramm [11] for previous work on triangulations). We will not discuss the subtleties of planar maps nor the details of the construction of the UIPQ and refer the interested reader to [89, 101, 111].

The UIPQ is an random infinite graph  $Q_\infty$  (which is viewed as embedded in the plane) given with a distinguished oriented edge  $\vec{e}$ . We will forget the planar structure of the UIPQ and get a random rooted graph  $(Q_\infty, \rho)$ , which is rooted at the origin  $\rho$  of  $\vec{e}$ . One of the main open questions about this random infinite graph is its conformal

type, namely is it (almost surely) recurrent or transient? It has been conjectured in [11] (for the related Uniform Infinite Planar Triangulation) that  $Q_\infty$  is almost surely recurrent. Although we know that the conformal type of the Riemann surface obtained from the UIPQ by gluing squares along edges is parabolic [71] (see [11] for related result on the Circle Packing), yet the absence of the bounded degree property prevents one from using the results of [21] to get recurrence of the simple random walk on the UIPQ. Corollary 5.2 may be seen as providing a first step towards the proof recurrence.

*Proof of Corollary 5.2.* The random rooted graph  $(Q_\infty, \rho)$  is a stationary random graph. A proof of this fact can be found in [90, Section 1.3] or [49]. By virtue of Theorem 5.1, we just have to show that  $(Q_\infty, \rho)$  is of subexponential growth. To be completely accurate, we have to note that the graph  $(Q_\infty, \rho)$  is not simple, that is contains loops and multiple edges. However, it is easy to check that Theorem 5.1 still holds in this more general setting. Thanks to [111], we know that the random infinite quadrangulation investigated in [42] has the same distribution as the UIPQ. Hence, the volume estimate of [42] can be translated into

$$\mathbf{E} [\#B_{Q_\infty}(\rho, n)] = \Theta(n^4). \tag{5.19}$$

Hence Jensen’s inequality proves that the UIPQ is of subexponential growth in the sense of (5.1) which finishes the proof of the corollary.  $\square$

This corollary does not use the planar structure of UIPQ but only the invariance with respect to SRW and the subexponential growth. We believe that the result of Corollary 5.2 also holds for the UIPT. A detailed proof could be given along the preceding lines but would require an extension of the estimates (5.19) (Angel [10] provides almost sure estimates that are closely related to (5.19) for the UIPT).

### 5.5.2 Long range percolation clusters

Consider the graph obtained from  $\mathbb{Z}^d$  by adding an edge between each pair of distinct vertices  $x, y \in \mathbb{Z}^d$  with probability  $p_{x,y}$  independently of the other pairs. Assume that

$$p_{x,y} = \beta|x - y|^{-s},$$

for some  $\beta > 0$  and  $s > 0$ . This model is called *long range percolation*. Berger [23] proved in dimensions  $d = 1$  or  $d = 2$  that if  $d < s < 2d$ , then conditionally on 0 being in an infinite cluster, this cluster is almost surely transient. In the same paper the following question [23, (6.3)] is addressed :

**Question 1.** *Are there nontrivial harmonic functions on the infinite cluster of long range percolation with  $d < s < 2d$  ?*

We answer negatively this question for *bounded* harmonic functions.

*Démonstration.* First we remark that by a general result (see [7, Example 9.4]), conditionally on the event that 0 belongs to an infinite cluster  $\mathcal{C}_\infty$ , the random rooted graph  $(\mathcal{C}_\infty, 0)$  is a unimodular random graph. Furthermore, since  $s > d$  the expected degree

of 0 is finite. Hence, by Proposition 5.8, the random graph  $(\tilde{\mathcal{C}}_\infty, \tilde{0})$  obtained by biasing  $(\mathcal{C}_\infty, 0)$  with the degree of 0 is stationary. By Theorem 5.1 it suffices to show that the graph  $\tilde{\mathcal{C}}_\infty$  is of subexponential growth in the sense of (5.1). For that purpose, we use the estimates given in [29, Theorem 3.1]. For  $x \in \mathcal{C}_\infty$ , denote the graph distance from 0 to  $x$  in  $\mathcal{C}_\infty$  by  $d_{\text{gr}}^{\mathcal{C}_\infty}(0, x)$ . Then for each  $s' \in (d, s)$  there are constants  $c_1, c_2 \in (0, +\infty)$  such that, for  $\delta' = 1/\log_2(2d/s')$ ,

$$\mathbf{P} \left( d_{\text{gr}}^{\mathcal{C}_\infty}(0, x) \leq n \right) \leq c_1 \left( \frac{e^{c_2 n^{1/\delta'}}}{|x|} \right)^{s'}.$$

In particular, we deduce that

$$\mathbf{E} [\#B_{\mathcal{C}_\infty}(0, n)] \leq \kappa_1 \exp \left( \kappa_2 n^{1/\delta'} \right), \tag{5.20}$$

where  $\kappa_1$  and  $\kappa_2$  are positive constants. Remark that  $\delta' > 1$ . Thus we have, if  $\text{deg}(0)$  denotes the degree of 0 in  $\mathcal{C}_\infty$ ,

$$\begin{aligned} \mathbf{E} [\log(\#B_{\tilde{\mathcal{C}}_\infty}(\tilde{0}, n))] &= \frac{1}{\mathbf{E}[\text{deg}(0)]} \mathbf{E} [\text{deg}(0) \log(\#B_{\mathcal{C}_\infty}(0, n))] \\ &\leq \frac{1}{\mathbf{E}[\text{deg}(0)]} \sqrt{\mathbf{E}[\text{deg}(0)^2] \mathbf{E}[\log^2(\#B_{\mathcal{C}_\infty}(0, n))]}, \end{aligned} \tag{5.21}$$

by the Cauchy-Schwarz inequality. Since  $s > d$  it is easy to check that the second moment of  $\text{deg}(0)$  is finite. Furthermore, the function  $x \mapsto \log^2(x)$  is concave on  $]e, \infty[$  so by Jensen’s inequality we have

$$\mathbf{E} \left[ \log^2(\#B_{\mathcal{C}_\infty}(0, n)) \right] \leq \log^2 \left( \mathbf{E} [\#B_{\mathcal{C}_\infty}(0, n)] + 2 \right).$$

Hence, combining the last display with (7.7) and (7.8) we deduce that  $(\tilde{\mathcal{C}}_\infty, 0)$  is of subexponential growth in the sense of (5.1).  $\square$

**Remark 5.20.** *It is also possible to derive this corollary from [80, Theorem 4], however we preferred to stick to the context of unimodular random graphs.*

Note that by similar considerations, clusters of any invariant percolation on a group, in which the clusters have subexponential volume growth are Liouville, see [18] for many examples. This holds in particular for Bernoulli percolation on Cayley graphs of subexponential growth, e.g. on  $\mathbb{Z}^d$ .

### 5.5.3 Planarity

Simply connected planar Riemannian surfaces are either conformal to the Euclidean or to the hyperbolic plane. Thus they are either recurrent for Brownian motion or admit non constant bounded harmonic functions. The same alternative holds for planar graphs of *bounded degree*. They are either recurrent for the simple random walk or admit non constant bounded harmonic functions [19]. Combining Theorem 5.1 with these results related to planarity yields :

**Corollary 5.21.** *Let  $(G, \rho)$  be a stationary random graph with subexponential growth in the sense of (5.1). Suppose furthermore that almost surely  $(G, \rho)$  is planar and has bounded degree. Then  $(G, \rho)$  is almost surely recurrent.*

*Démonstration.* We already know by Theorem 5.1 that  $(G, \rho)$  is almost surely Liouville. In [19] it is shown that a transient planar graph with bounded degree admits non constant bounded harmonic functions. Therefore  $G$  must be recurrent almost surely.  $\square$

Note that without the bounded degree assumption it is easy to construct planar transient Liouville graphs, see [19]. However these graphs are not stationary. The following construction shows that the bounded degree assumption is needed in the last corollary : We construct a stationary and reversible random graph that is of subexponential growth but transient.

We consider the sequence  $\epsilon_1, \dots, \epsilon_n, \dots \in \{1, 2\}$  defined recursively as follows. Start with  $\epsilon_1 = 1$ , if  $\epsilon_1, \dots, \epsilon_k$  are constructed we let  $\xi_k = \prod_{i=1}^k \epsilon_k$ , and set  $\epsilon_{k+1} = 1$  if  $\xi_k > k^4$  and  $\epsilon_{k+1} = 2$  otherwise. Clearly there exists a constant  $0 < c < C < \infty$  such that  $ck^4 \leq \xi_k \leq Ck^4$  for every  $k \geq 1$ . We now consider the tree  $T_n$  of height  $n$ , starting from an initial ancestor at height 0 such that each vertex at height  $0 \leq k \leq n - 1$  has  $\epsilon_{n-k}$  children. Hence the tree  $T_n$  has only simple or binary branchings. The *depth*  $D(u)$  of a vertex  $u$  in  $T_n$  is  $n$  minus its height. For example the leaves of  $T_n$  have depth 0. The depth of an edge is the maximal depth of its ends. If  $u$  is a leaf of  $T_n$  then for every  $0 \leq r \leq n$ , the ball of radius  $r$  around  $u$  in  $T_n$  is contained in the set of descendants of the ancestor of  $u$  at depth  $r$ . This subtree has precisely  $\sum_{i=0}^r \xi_r / \xi_{r-i}$  vertices (with the convention  $\xi_0 = 1$ ) so we deduce that

$$\#B_{T_n}(u, r) \leq \sum_{i=0}^r \frac{\xi_r}{\xi_{r-i}} \leq C' r^4, \tag{5.22}$$

for some  $C'$  independent of  $r$ . It is easy to see that the last bound still holds for any vertex  $u \in T_n$  (not necessarily a leaf) provided that we replace  $C'$  by  $3C'$ . We also introduce the tree  $T_\infty$  which is composed of an infinite number of vertices at depth  $0, 1, 2, 3, \dots$  such that each vertex at depth  $k$  is linked to  $\epsilon_{k+1}$  vertices at depth  $k - 1$ . Now we consider the graphs  $T_n^R$  and  $T_\infty^R$  obtained from  $T_n$  and  $T_\infty$  by replacing each edge at depth  $k$  by  $k^2$  parallel edges. The graph  $T_\infty^R$  is obviously a tree with multiple edges that has only one end. Furthermore the number of parallel edges along an infinite geodesic in  $T_\infty^R$  grows sufficient fast enough so that the simple random walk on  $T_\infty^R$  is transient.

We transform these deterministic graphs into random ones. The root  $\rho_n$  is chosen among all vertices of  $T_n^R$  proportionally to the degree. This boils down to picking an oriented edge uniformly at random in  $T_n^R$  and consider its starting point  $\rho_n$ .

**Proposition 5.22.** *We have the convergence in distribution for  $d_{loc}$*

$$(T_n^R, \rho_n) \xrightarrow{n \rightarrow \infty} (T_\infty^R, \rho), \tag{5.23}$$

*for a particular choice of a random root  $\rho \in T_\infty^R$ . In particular  $(T_\infty^R, \rho)$  is a planar transient stationary and reversible random graph of subexponential growth.*

*Démonstration.* It is enough to show that  $D(\rho_n)$  converges in distribution to a non degenerate random variable denoted by  $D$  as  $n \rightarrow \infty$ . Indeed if we choose a random root  $\rho \in T_\infty^R$  with depth given by  $D$ , since the  $r$ -neighborhood of a vertex at depth  $k$  in  $T_n^R$  and in  $T_\infty^R$  are the same when  $n \geq r + k$ , we easily deduce the weak convergence of  $(T_n^R, \rho_n)$  to  $(T_\infty^R, \rho)$  for  $d_{\text{loc}}$ . Furthermore since the random rooted graphs  $(T_n^R, \rho_n)$  are stationary and reversible (see Example 5.2), the same holds for  $(T_\infty^R, \rho)$  as weak limit of stationary and reversible graphs in the sense of  $d_{\text{loc}}$ .

Let  $k \geq 0$ . The probability that  $D(\rho_n) = k$  is exactly the proportion of oriented edges whose origin is a vertex of depth  $k$ . Thus with the convention  $\xi_0, \xi_{-1} = 1$  we have

$$\mathbb{P}(D(\rho_n) = k) = \left( k^2 \frac{\xi_n}{\xi_{k-1}} + (k+1)^2 \frac{\xi_n}{\xi_k} \right) \left( 2\xi_n \sum_{i=0}^{n-1} \frac{(i+1)^2}{\xi_i} \right)^{-1}.$$

Since  $\xi_k \geq ck^4$ , clearly the series  $\sum i^2 \xi_i^{-1}$  converges. Hence, the probabilities in the last display converge when  $n \rightarrow \infty$ , thus proving the convergence in distribution of  $D(\rho_n)$ . Furthermore, using (5.22) and the following remark following it, it is easy to see that  $\#B_{T_\infty}(\rho, r) \leq 3C'r^4$ , hence  $T_\infty^R$  is of subexponential growth.  $\square$

### Questions

- In the preceding construction, the degree of  $\rho$  in  $T_\infty^R$  has a polynomial tail. Is it possible to construct a planar stationary and reversible graph of subexponential growth such that the degree of the root vertex has an exponential tail for which the SRW is transient?
- Let  $(G, \rho)$  be a limit in distribution of finite *planar* stationary graphs for  $d_{\text{loc}}$  (see [21]). Is it the case that  $(G, \rho)$  is almost surely Liouville<sup>1</sup>? Does SRW on  $(G, \rho)$  have zero speed?
- In [16] a generalization of limits of finite planar graphs to graphs associated to sphere packings in  $\mathbb{R}^d$  was studied. Extend the preceding questions to these graphs.

---

1. There are local limits of finite planar graphs with exponential growth. For example local limit of full binary trees up to level  $n$  with the root picked according to the degree

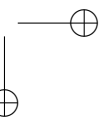
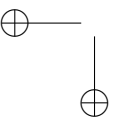
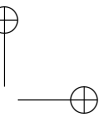
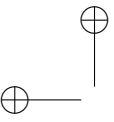



## The UIPQ seen from $\infty$

---

**Disclaimer :** The results of this chapter are taken from a work *in progress* with Laurent Ménard and Grégory Miermont.

We introduce a new construction of the Uniform Infinite Planar Quadrangulation (UIPQ). Our approach is based on an extension of the Cori-Vauquelin-Schaeffer mapping in the context of infinite trees. We release the positivity constraint on the labels of trees which was imposed in previous work [42, 101, 111], this leads to a considerable simplification of the calculations. This approach allows us to prove the conjectures of Krikun [89, 90] and to derive new results about the UIPQ, among which a fine study of infinite geodesics in the UIPQ and a comparison principle linking the UIPQ with large finite quadrangulations.

### 6.1 Introduction

In this work, a new approach to the Uniform Infinite Planar Quadrangulation (UIPQ) is developed. We show that the UIPQ can be constructed from a random infinite labeled tree by extending a bijection due to Cori, Vauquelin and Schaeffer between labeled trees and rooted and pointed quadrangulations. In contrast with previous works [42, 101, 111], the labels of the random infinite tree that we consider are not conditioned to stay non-negative. This simplifies the computations and enable us to derive new results easily.

A planar map is a proper embedding of a finite connected graph in the two-dimensional sphere, viewed up to orientation-preserving homeomorphisms of the sphere. The faces are the connected components of the complement of the union of the edges. A map is a triangulation (respectively a quadrangulation) if all its faces have degree three (respectively four). A map is rooted if one has distinguished an oriented edge called the root edge. Planar maps are basic objects in combinatorics and have been extensively studied since the work of Tutte in the sixties [142]. They also popped out in various areas, such as algebra and geometry [93], random matrices [147] and theoretical physics where they have been used as a model of random geometry [9]. Although triangulations seem more natural than quadrangulations, we will focus on quadrangulations. We do so mainly because of the existence of a very nice bijection between, on the one hand, rooted planar quadrangulations with  $n$  faces, and on the other hand, labeled planar trees with  $n$  edges and non-negative labels. This bijection is due to Cori and Vauquelin

[45] and was later generalized and popularized by Schaeffer [127]. See Section 6.2.3.

In a pioneer work [11], Angel and Schramm introduced the Uniform Infinite Planar Triangulation (UIPT) as the limit of non-rescaled large random rooted triangulations. Later Krikun [89] defined a similar object, the Uniform Infinite Planar Quadrangulation (UIPQ), in the setting of quadrangulations. Let us describe quickly the point of view of Krikun. If  $q, q'$  are two rooted quadrangulations, the local distance between  $q$  and  $q'$  is

$$d_{\mathbf{Q}}(q, q') = (1 + \sup\{r \geq 0 : B_{\mathbf{Q},r}(q) = B_{\mathbf{Q},r}(q')\})^{-1},$$

where  $B_{\mathbf{Q},r}(q)$  denotes the map formed by the faces of  $q$  that have at least one vertex at graph distance smaller than or equal to  $r$  from the origin of the root edge in  $q$ . If  $Q_n$  is a random rooted quadrangulation uniformly distributed over the set of all rooted quadrangulations with  $n$  faces, then we have [89]

$$Q_n \xrightarrow[n \rightarrow \infty]{(d)} Q_{\infty},$$

in distribution in the sense of  $d_{\mathbf{Q}}$ . The object  $Q_{\infty}$  is a random infinite rooted quadrangulation called the Uniform Infinite Planar Quadrangulation (UIPQ), see Section 6.2.2 for more details. The UIPQ and its brother the UIP $T$  are fundamental objects in random geometry and have triggered a lot of work [10, 11, 15, 89, 90, 91].

Extending the Cori-Vauquelin-Schaeffer bijection, Chassaing and Durhuus [42] introduced another construction of the UIPQ (shown to be equivalent to Krikun’s approach in [111]) based on a random infinite labeled tree with non-negative labels. In this approach the labels in the random infinite tree correspond to distances from the origin of the root edge in the quadrangulation, and thus information about the labels can be used to derive geometric properties such as volume growth around the root in the UIPQ [42, 101, 111]. In this work, we release the positivity constraint on the labels and give another construction of the UIPQ. Though the labels no longer correspond to distances from the root of the UIPQ, yet they still have a metric interpretation as “distances seen from infinity”. Let us briefly describe our construction.

We denote by  $T_{\infty}$  the critical geometric Galton-Watson tree conditioned to survive. This random infinite planar tree with one end has been introduced by Kesten [85] and can be built from a semi-infinite line of vertices  $x_0 - x_1 - x_2 - \dots$  together with independent critical geometric Galton-Watson trees grafted to the left-hand side and right-hand side of each vertex  $x_i$  for  $i \geq 0$ , see Section 6.2.4. Conditionally on  $T_{\infty}$ , we consider a sequence of independent variables  $(d_e)_{e \in E(T_{\infty})}$  indexed by the edges of  $T_{\infty}$  which are uniformly distributed over  $\{-1, 0, +1\}$ . We then assign to every vertex  $u$  of  $T_{\infty}$  a label  $\ell(u)$  corresponding to the sum of the numbers  $d_e$  along the ancestral path from  $u$  to the root  $x_0$  of  $T_{\infty}$ . Given an extra Bernoulli variable  $\eta \in \{0, 1\}$  independent of  $(T_{\infty}, \ell)$ , it is then possible to extend the classical Schaeffer’s construction to define a quadrangulation  $\Phi((T_{\infty}, \ell), \eta)$  from  $(T_{\infty}, \ell)$  and  $\eta$ , see Section 6.2.3. The only role of  $\eta$  is to prescribe the orientation of the root edge in  $\Phi((T_{\infty}, \ell), \eta)$ . The random infinite rooted quadrangulation  $Q_{\infty} = \Phi((T_{\infty}, \ell), \eta)$  has the distribution of the UIPQ, see Theorem 6.9. Moreover, the vertices of  $Q_{\infty}$  correspond to those of  $T_{\infty}$  and via this

identification, Theorem 6.9 gives a simple interpretation of the labels : Almost surely, for any pair of vertices  $u, v$  of  $Q_\infty$

$$\ell(u) - \ell(v) = \lim_{z \rightarrow \infty} \left( d_{\text{gr}}^{Q_\infty}(u, z) - d_{\text{gr}}^{Q_\infty}(v, z) \right). \quad (*)$$

The fact that the limit exists as  $z \rightarrow \infty$  in  $(*)$  means that the right-hand side is constant everywhere but on a finite subset of vertices of  $Q_\infty$ . Theorem 6.9 and its corollaries also answer positively the three conjectures raised by Krikun in [90]. Note that the existence of the limit in  $(*)$  was shown in [90]. It also follows from our fine study of the geodesics and their coalescence properties in the UIPQ, see Proposition 6.10 and Theorem 6.13. Let us discuss another way to look at large random planar maps, which is parallel to the theory of local limit of random maps and the UIPQ or UIPT. Following ideas of Chassaing and Schaeffer [43], one would like to understand the *global* geometry of  $Q_n$ , a large random rooted quadrangulation with  $n$  faces, as opposed to the *local* geometry captured by the UIPQ. The vertex set  $V(Q_n)$  of  $Q_n$  is equipped with the graph distance  $d_{\text{gr}}^{Q_n}(\cdot, \cdot)$  and one is interested in showing the convergence in distribution for the Gromov-Hausdorff distance of the rescaled maps

$$(V(Q_n), n^{-1/4} d_{\text{gr}}^{Q_n}(\cdot, \cdot)) \xrightarrow[n \rightarrow \infty]{?} (M_\infty, D), \quad (**)$$

the rescaling factor  $n^{-1/4}$  corresponding roughly to the inverse of the diameter of  $Q_n$ , as shown in [43]. The (conjectured) limiting random compact metric space  $(M_\infty, D)$  is called the “Brownian Map”. Though the convergence  $(**)$  is still unproved, it has been shown [98] that it holds along certain subsequences, and that the Brownian maps share common properties [48, 102, 99]. In Section 6.4.1 we compare scaling limits of large balls  $B_{Q,r}(Q_\infty)$  in the UIPQ with scaling limits of large random planar quadrangulations. Our comparison principle enables us to transfer known results about the Brownian Map to the UIPQ and conversely. For example, we settle a conjecture of Krikun [89] on separating cycles in the UIPQ as a corollary of the homeomorphism theorem for the Brownian Map due to Le Gall & Paulin [102].

The paper is organized as follows. In Section 2 we introduce the construction of the UIPQ based on a random infinite labeled tree and present our main theorem. Section 3 is devoted to the proof of Theorem 6.9, which goes through an analysis of discrete geodesics in the UIPQ. In particular, we establish a confluence property of geodesic towards the root (Proposition 6.10) and a certain uniqueness property of geodesic rays towards infinity (Theorem 6.13). The last section, which is devoted to applications, contains the comparison principle with the Brownian Map.

**Acknowledgments :** We deeply thank Jean-François Le Gall for fruitful discussions and a careful reading of a first version of this article.

## 6.2 Random trees and the UIPQ

### 6.2.1 Spatial trees

Throughout this work we will use the standard formalism for planar trees as found in [121]. Let

$$\mathcal{U} = \bigcup_{n=0}^{\infty} \mathbb{N}^n$$

where  $\mathbb{N} = \{1, 2, \dots\}$  and  $\mathbb{N}^0 = \{\emptyset\}$  by convention. An element  $u$  of  $\mathcal{U}$  is thus a finite sequence of positive integers. If  $u, v \in \mathcal{U}$ ,  $uv$  denotes the concatenation of  $u$  and  $v$ . If  $v$  is of the form  $uj$  with  $j \in \mathbb{N}$ , we say that  $u$  is the *parent* of  $v$  or that  $v$  is a *child* of  $u$ . More generally, if  $v$  is of the form  $uw$ , for  $u, w \in \mathcal{U}$ , we say that  $u$  is an *ancestor* of  $v$  or that  $v$  is a *descendant* of  $u$ . A *rooted planar tree*  $\tau$  is a (finite or infinite) subset of  $\mathcal{U}$  such that

1.  $\emptyset \in \tau$  ( $\emptyset$  is called the *root* of  $\tau$ ),
2. if  $v \in \tau$  and  $v \neq \emptyset$ , the parent of  $v$  belongs to  $\tau$
3. for every  $u \in \mathcal{U}$  there exists  $k_u(\tau) \geq 0$  such that  $uj \in \tau$  if and only if  $j \leq k_u(\tau)$ .

A rooted planar tree can be seen as a graph, in which an edge links two vertices  $u, v$  such that  $u$  is the parent of  $v$  or vice-versa. This graph is of course a tree in the graph-theoretic sense, and has a natural embedding in the plane, in which the edges from a vertex  $u$  to its children  $u1, \dots, uk_u(\tau)$  are drawn from left to right.

We let  $|u|$  be the length of the word  $u$ . The number  $H(\tau) = \max_{u \in \tau} |u|$  is called the height of  $\tau$ . The integer  $|\tau|$  denotes the number of edges of  $\tau$  and is called the size of  $\tau$ . A *spine* in a tree  $\tau$  is an infinite sequence  $u_0, u_1, u_2, \dots$  in  $\tau$  such that  $u_0 = \emptyset$  and  $u_i$  is the parent of  $u_{i+1}$  for every  $i \geq 0$ . If  $a$  and  $b$  are two vertices of a tree  $\tau$ , we denote the set of vertices along the unique geodesic line going from  $a$  to  $b$  in  $\tau$  by  $[[a, b]]$ .

A *rooted labeled tree* (or spatial tree) is a pair  $\theta = (\tau, (\ell(u))_{u \in \tau})$  that consists of a rooted planar tree  $\tau$  and a collection of integer labels assigned to the vertices of  $\tau$ , such that if  $u, v \in \tau$  and  $v$  is a child of  $u$ , then  $|\ell(u) - \ell(v)| \leq 1$ . For every  $l \in \mathbb{Z}$ , we denote by  $\mathbf{T}^{(l)}$  the set of spatial trees for which  $\ell(\emptyset) = l$ , and  $\mathbf{T}_{\infty}^{(l)}$ , resp.  $\mathbf{T}_f^{(l)}$ , resp.  $\mathbf{T}_n^{(l)}$ , are the subsets of  $\mathbf{T}^{(l)}$  consisting of the infinite trees, resp. finite trees, resp. trees with  $n$  edges. If  $\theta = (\tau, \ell)$  is a labeled tree,  $|\theta| = |\tau|$  is the size of  $\theta$  and  $H(\theta) = H(\tau)$  is the height of  $\theta$ .

If  $\theta$  is a spatial tree and  $h \geq 0$  is an integer, we denote the labeled subtree of  $\theta$  consisting of all vertices of  $\theta$  and their labels up to height  $h$  by  $B_{\mathbf{T}, h}(\theta)$ . For every pair  $\theta, \theta'$  of spatial trees define

$$d_{\mathbf{T}}(\theta, \theta') = (1 + \sup \{h : B_{\mathbf{T}, h}(\theta) = B_{\mathbf{T}, h}(\theta')\})^{-1}$$

One easily checks that  $d_{\mathbf{T}}$  is a distance on the set of all spatial trees, which turns this set into a separable and complete metric space.

In the rest of this work we will mostly be interested in the following set of infinite trees. We let  $\mathcal{S}$  be the set of all labeled trees  $(\tau, \ell)$  in  $\mathbf{T}_{\infty}^{(0)}$  such that

- $\tau$  has exactly one spine, which we denote by  $\varnothing = S_\tau(0), S_\tau(1), S_\tau(2), \dots$
- $\inf_{i \geq 0} \ell(S_\tau(i)) = -\infty$ .

**Contour functions.** A finite spatial tree  $\theta = (\tau, \ell)$  can be encoded by a pair  $(C_\theta, V_\theta)$ , where  $C_\theta = (C_\theta(t))_{0 \leq t \leq 2|\theta|}$  is the contour function of  $\tau$  and  $V_\theta = (V_\theta(t))_{0 \leq t \leq 2|\theta|}$  is the spatial contour function of  $\theta$ . To define these contour functions, let us consider a particle which, starting from the root, traverses the tree along its edges at speed one. When leaving a vertex, the particle moves towards the first non visited child of this vertex if there is such a child, or returns to the parent of this vertex. Since all edges will be crossed twice, the total time needed to explore the tree is  $2|\theta|$ . For every  $t \in [0, 2|\theta|]$ ,  $C_\theta(t)$  denotes the distance from the root of the position of the particle at time  $t$ . In addition if  $t \in [0, 2|\theta|]$  is an integer,  $V_\theta(t)$  denotes the label of the vertex that is visited at time  $t$ . We then complete the definition of  $V_\theta$  by interpolating linearly between successive integers. See Figure 6.1 for an example. A finite spatial tree is uniquely determined by its pair of contour functions. It will sometimes be convenient to define the functions  $C_\theta$  and  $V_\theta$  for every  $t \geq 0$ , by setting  $C_\theta(t) = 0$  and  $V_\theta(t) = V_\theta(0)$  for every  $t \geq 2|\theta|$ .

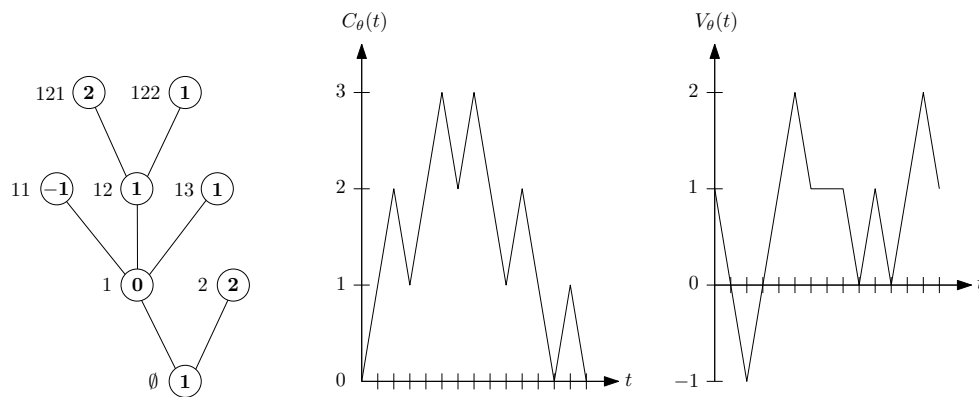

FIGURE 6.1 – A spatial tree  $\theta$  and its pair of contour functions  $(C_\theta, V_\theta)$ .

A tree  $\theta \in \mathcal{S}$  can obviously be coded by two pairs of contour functions,

$$(C_\theta^{(L)}, V_\theta^{(L)}) : \mathbb{R}_+ \rightarrow \mathbb{R}_+ \times \mathbb{R} \quad \text{and} \quad (C_\theta^{(R)}, V_\theta^{(R)}) : \mathbb{R}_+ \rightarrow \mathbb{R}_+ \times \mathbb{R},$$

each pair coding one side of the spine. Note that to define the pair  $(C_\theta^{(L)}, V_\theta^{(L)})$ , we follow the contour of the tree (starting from the root) from the left to the right as before, but in order to define  $(C_\theta^{(R)}, V_\theta^{(R)})$  we follow the contour from right to the left. The definition of these contour functions should be clear from Fig. 6.2.

### 6.2.2 Finite and infinite quadrangulations

Consider a proper embedding of a finite connected graph in the sphere  $S_2$  (loops and multiple edges are allowed). A *finite planar map*  $m$  is an equivalence class of such

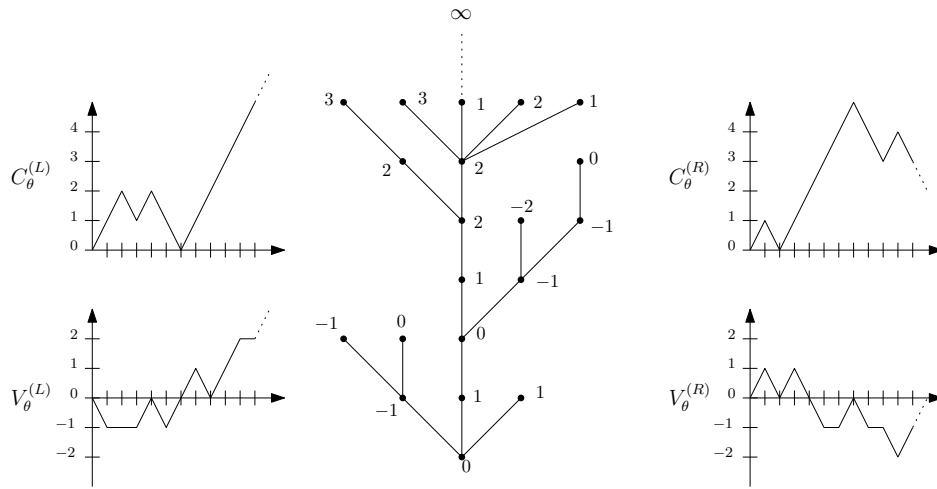

FIGURE 6.2 – A tree  $\theta \in \mathcal{S}$  and its contour functions  $(C_\theta^{(L)}, V_\theta^{(L)})$ ,  $(C_\theta^{(R)}, V_\theta^{(R)})$ .

embeddings modulo orientation preserving homeomorphisms of the sphere. Let  $\vec{E}(m)$  be the set of all oriented edges of  $m$  (each edge corresponds to exactly two oriented edges). A planar map is *rooted* if it has a distinguished oriented edge  $e^* \in \vec{E}(m)$ , which is called the root edge. If  $e$  is an oriented edge of a map we write  $e_-$  and  $e_+$  for its origin and target vertices and  $\overleftarrow{e}$  for the reversed edge.

The set of vertices of a map  $m$  is denoted by  $V(m)$ . We will equip  $V(m)$  with the graph distance : If  $v$  and  $v'$  are two vertices,  $d_{\text{gr}}^m(v, v')$  is the minimal number of edges on a path from  $v$  to  $v'$  in  $m$ . If  $v \in V(m)$ , the *degree* of  $v$  is the number of oriented edges pointing towards  $v$  and is denoted by  $\text{deg}(v)$ .

The *faces* of the map are the connected components of the complement of the union of its edges. The *degree* of a face is the number of edges that are incident to it, where it should be understood that an edge lying entirely in a face is incident twice to this face. A finite planar map is a *quadrangulation* if all its faces have degree 4, that is 4 incident edges. A planar map is a *quadrangulation with holes* if all its faces have degree 4, except for a number of distinguished faces which can be of arbitrary even degrees. We call these faces the *holes*, or the *boundaries* of the quadrangulation.

### Infinite quadrangulations and their planar embeddings

Let us introduce infinite quadrangulations using the approach of Krikun [89], see also [11, 21]. For every integer  $n \geq 1$ , we denote by  $\mathbf{Q}_n$  the set of all rooted quadrangulations with  $n$  faces. For every pair  $q, q' \in \mathbf{Q}_f = \bigcup_{n \geq 1} \mathbf{Q}_n$  we define

$$d_{\mathbf{Q}}(q, q') = (1 + \sup \{r : B_{\mathbf{Q}, r}(q) = B_{\mathbf{Q}, r}(q')\})^{-1}$$

where, for  $r \geq 1$ ,  $B_{\mathbf{Q}, r}(q)$  is the planar map whose edges (resp. vertices) are all edges (resp. vertices) incident to a face of  $q$  having at least one vertex at distance strictly

smaller than  $r$  from the root vertex  $e_-^*$ , and  $\sup \emptyset = 0$  by convention. Note that  $B_{\mathbf{Q},r}(q)$  is a quadrangulation with holes.

The pair  $(\mathbf{Q}_f, d_{\mathbf{Q}})$  is a metric space, we let  $(\mathbf{Q}, d_{\mathbf{Q}})$  be the completion of this space. We call *infinite quadrangulations* the elements of  $\mathbf{Q}$  that are not finite quadrangulations and we denote the set of all such quadrangulations by  $\mathbf{Q}_\infty$ . Note that one can extend the function  $q \in \mathbf{Q}_f \mapsto B_{\mathbf{Q},r}(q)$  to a continuous function  $B_{\mathbf{Q},r}$  on  $\mathbf{Q}$ .

**Infinite quadrangulations of the plane.** An infinite quadrangulation  $q$  defines a unique infinite graph  $G$  with a root edge, together with a consistent family of planar embeddings  $(B_{\mathbf{Q},r}(q), r \geq 1)$  of the combinatorial balls of  $G$  centered at the root vertex.

Conversely, any sequence  $q_1, q_2, \dots$  of rooted quadrangulations with holes, such that  $q_r = B_{\mathbf{Q},r}(q_{r+1})$  for every  $r \geq 1$ , specifies a unique infinite quadrangulation  $q$  whose ball of radius  $r$  is  $q_r$  for every  $r \geq 1$ .

**Definition 6.1.** *An infinite quadrangulation  $q \in \mathbf{Q}_\infty$  is called a quadrangulation of the plane if it has one end, that is, if for any  $r \geq 0$  the graph  $q \setminus B_{\mathbf{Q},r}(q)$  has only one infinite connected component.*

It is not hard to convince oneself that quadrangulations of the plane also coincide with equivalence classes of certain proper embeddings of infinite graphs in the plane  $\mathbb{R}^2$ , viewed up to orientation preserving homeomorphisms. Namely these are the proper embeddings  $\chi$  of locally finite planar graphs such that

- every compact subset of  $\mathbb{R}^2$  intersects only finitely many edges of  $\chi$ ,
- the connected components of the complement of the union of edges of  $\chi$  in  $\mathbb{R}^2$  are all bounded topological quadrangles.

**Remark 6.2.** *Note that a generic element of  $\mathbf{Q}_\infty$  is not necessarily a quadrangulation of the plane. See [11, 42, 111] and the Appendix below for more details about this question.*

### The Uniform Infinite Planar Quadrangulation

Now, let  $Q_n$  be a random variable with uniform distribution on  $\mathbf{Q}_n$ . Then as  $n \rightarrow \infty$ , the sequence  $(Q_n)_{n \geq 1}$  converges in distribution to a random variable with values in  $\mathbf{Q}_\infty$ .

**Theorem 6.3** ([89]). *For every  $n \geq 1$ , let  $\nu_n$  be the uniform probability measure on  $\mathbf{Q}_n$ . The sequence  $(\nu_n)_{n \geq 1}$  converges to a probability measure  $\nu$ , in the sense of weak convergence in the space of probability measures on  $(\mathbf{Q}, d_{\mathbf{Q}})$ . Moreover,  $\nu$  is supported on the set of infinite rooted quadrangulations of the plane.*

The probability measure  $\nu$  is called the law of the uniform infinite planar quadrangulation (UIPQ). This result was shown by Krikun [89], following an idea initially developed by Angel and Schramm [11] for triangulations.

### 6.2.3 The Schaeffer correspondence

One of the main tools for studying random quadrangulations is a bijection due to Cori & Vauquelin [45] and popularized by Schaeffer [127]. It establishes a one-to-one correspondence between rooted and pointed quadrangulations with  $n$  faces, and pairs consisting of a spatial tree of  $\mathbf{T}_n^{(0)}$  and an element of  $\{0, 1\}$ . Let us describe this correspondence and its extension to infinite quadrangulations.

#### From trees to quadrangulations

A rooted and *pointed* quadrangulation is a pair  $\mathbf{q} = (q, \rho)$  where  $q$  is a rooted quadrangulation and  $\rho$  is a distinguished vertex of  $q$ . We write  $\mathbf{Q}_n^\bullet$  for the set of all rooted and pointed quadrangulations with  $n$  faces. We first describe the mapping from spatial trees to quadrangulations.

Let  $\theta = (\tau, \ell)$  be an element of  $\mathbf{T}_n^{(0)}$ . We view  $\tau$  as embedded in the plane. A *corner* of a vertex in  $\tau$  is an angular sector formed by two consecutive edges in clockwise order around this vertex. Note that a vertex of degree  $k$  in  $\tau$  has exactly  $k$  corners. If  $c$  is a corner of  $\tau$ ,  $\mathcal{V}(c)$  denotes the vertex incident to  $c$ . By extension, the label of a corner  $c$  is the label of  $\mathcal{V}(c)$ .

We consider the sequence  $(c_0, c_1, c_2, \dots, c_{2n-1})$  of corners visited during the contour process of  $\tau$ , starting from the corner  $c_0$  incident to  $\emptyset$  that is located to the left of the oriented edge going from  $\emptyset$  to 1 in  $\tau$ . We extend this sequence of corners to a sequence  $(c_i, i \geq 0)$  by periodicity, letting  $c_{i+2n} = c_i$ . For  $i \in \mathbb{Z}_+$ , the *successor*  $\mathcal{S}(c_i)$  of  $c_i$  is the first corner  $c_j$  in the list  $c_{i+1}, c_{i+2}, c_{i+3}, \dots$  such that the label  $\ell(c_j)$  of  $c_j$  is equal to  $\ell(c_i) - 1$ , if such a corner exists. In the opposite case, the successor of  $c_i$  is an extra element  $\partial$ , not in  $\{c_i, i \geq 0\}$ .

Finally, we construct a new graph as follows. Add an extra vertex  $\rho$  in the plane, that does not belong to (the embedding of)  $\tau$ . For every corner  $c$ , draw an arc between  $c$  and its successor if this successor is not  $\partial$ , or draw an arc between  $c$  and  $\rho$  if the successor of  $c$  is  $\partial$ . The construction can be made in such a way that the arcs do not cross. After the interior of the edges of  $\tau$  has been removed, the resulting embedded graph, with vertex set  $\tau \cup \{\rho\}$  and edges given by to the newly drawn arcs, is a quadrangulation  $q$ . In order to root this quadrangulation, we consider some extra parameter  $\eta \in \{0, 1\}$ . If  $\eta = 0$ , the root of  $q$  is the arc from  $c_0$  to its successor, oriented in this direction. If  $\eta = 1$  then the root of  $q$  is the same edge, but with opposite orientation. We let  $q = \Phi(\theta, \eta) \in \mathbf{Q}_n^\bullet$  ( $q$  comes naturally with the distinguished vertex  $\rho$ ).

**Theorem 6.4** (Theorem 4 in [43]). *The mapping  $\Phi : \mathbf{T}_n^{(0)} \times \{0, 1\} \longrightarrow \mathbf{Q}_n^\bullet$  is a bijection. If  $q = \Phi((\tau, \ell), \eta)$  then for every vertex  $v$  of  $q$  not equal to  $\rho$ , one has*

$$d_{\text{gr}}^q(v, \rho) = \ell(v) - \min_{u \in \tau} \ell(u) + 1, \tag{6.1}$$

where we recall that every vertex of  $q$  not equal to  $\rho$  is identified to a vertex of  $\tau$ .

Note that (6.1) can also be rewritten as

$$\ell(v) = d_{\text{gr}}^q(v, \rho) - d_{\text{gr}}^q(e_\pm^*, \rho), \quad v \in V(q), \tag{6.2}$$



where

$$e_{\pm}^* = \varnothing = \begin{cases} e_-^* & \text{if } d_{\text{gr}}^q(e_-^*, \rho) - d_{\text{gr}}^q(e_+^*, \rho) = -1 \\ e_+^* & \text{if } d_{\text{gr}}^q(e_-^*, \rho) - d_{\text{gr}}^q(e_+^*, \rho) = 1 \end{cases}$$

Hence, these labels can be recovered from the pointed quadrangulation  $(q, \rho)$ . This is of course not surprising since the function  $\Phi : \mathbf{T}_n^{(0)} \times \{0, 1\} \rightarrow \mathbf{Q}_n^\bullet$  is invertible (see the next section for the description of the inverse mapping).

**Infinite case.** We now aim at extending the construction of  $\Phi$  to elements of  $\mathcal{S}$ . Let  $(\tau, (\ell(u))_{u \in \tau}) \in \mathcal{S}$ . Again, we consider an embedding of  $\tau$  in the plane, with isolated vertices. This is always possible (since  $\tau$  is locally finite). The notion of a corner remains the same in this setting. We consider the sequence  $(c_0^{(L)}, c_1^{(L)}, c_2^{(L)}, \dots)$  of corners visited by the contour process of the left side of the tree, and similarly we denote the sequence of corners visited on the right side by  $(c_0^{(R)}, c_1^{(R)}, c_2^{(R)}, \dots)$ . Notice that  $c_0^{(L)} = c_0^{(R)}$  denotes the corner where the tree has been rooted. We now concatenate these two sequences into a unique sequence indexed by  $\mathbb{Z}$ , by letting, for  $i \in \mathbb{Z}$ ,

$$c_i = \begin{cases} c_i^{(L)} & \text{if } i \geq 0 \\ c_{-i}^{(R)} & \text{if } i < 0. \end{cases}$$

For any  $i \in \mathbb{Z}$ , the *successor*  $\mathcal{S}(c_i)$  of  $c_i$  is the first corner  $c_j$  in the list  $c_{i+1}, c_{i+2}, c_{i+3}, \dots$  such that the label  $\ell(c_j)$  of  $c_j$  is equal to  $\ell(c_i) - 1$ . From the assumption that  $\inf \ell(\mathcal{S}_\tau(i))$  is equal to  $-\infty$ , and since all the vertices of the spine appear in the sequence  $(c_i^{(L)})_{i \geq 0}$ , it holds that each corner has exactly one successor. We can associate with  $(\tau, (\ell(u))_{u \in \tau})$  an embedded graph  $q$  by drawing an arc between every corner and its successor. See Fig. 6.2.3. Note that, in contrast with the above description of the Schaeffer bijection on  $\mathbf{T}_n^{(0)} \times \{0, 1\}$ , we do not have to add an extra distinguished vertex  $\rho$  in this context.

In a similar way as before, the embedded graph  $q$  is rooted at the edge emerging from the distinguished corner  $c_0$  of  $\varnothing$ , that is, the edge between  $c_0$  and its successor  $\mathcal{S}(c_0)$ . The direction of the edge is given by an extra parameter  $\eta \in \{0, 1\}$ , similarly as above.

**Proposition 6.5.** *The resulting embedded graph  $q$  is an infinite quadrangulation of the plane, and the extended mapping  $\Phi : \mathcal{S} \cup \mathbf{T}_f^{(0)} \rightarrow \mathbf{Q}$  is continuous.*

*Démonstration.* We first check that every corner in  $\tau$  is the successor of only a finite set of other corners. Indeed, if  $c$  is such a corner, say  $c = c_i$  for  $i \in \mathbb{Z}$ , then from the assumption that  $\inf_j \ell(\mathcal{S}_\tau(j)) = -\infty$ , there exists a corner  $c_j$  with  $j < i$  such that the vertex incident to  $c_j$  belongs to the spine  $\{\mathcal{S}_\tau(0), \mathcal{S}_\tau(1), \dots\}$ , and  $\min_{j \leq k \leq i} \ell(c_k) < \ell(c_i) - 1$ . Therefore, for every  $k \leq j$ , the successor of  $c_k$  is not  $c_i$ .

This shows that the embedded graph  $q$  is locally finite, in the sense that every vertex is incident to a finite number of edges. The fact that every face of  $q$  is a quadrangle is then a consequence of the construction of the arcs, as proved e.g. in [43]. It remains to show that  $q$  can be properly embedded in the plane, that is, has one end. This comes from the construction of the edges and the fact that  $\tau$  has only one end. The details are left to the reader.

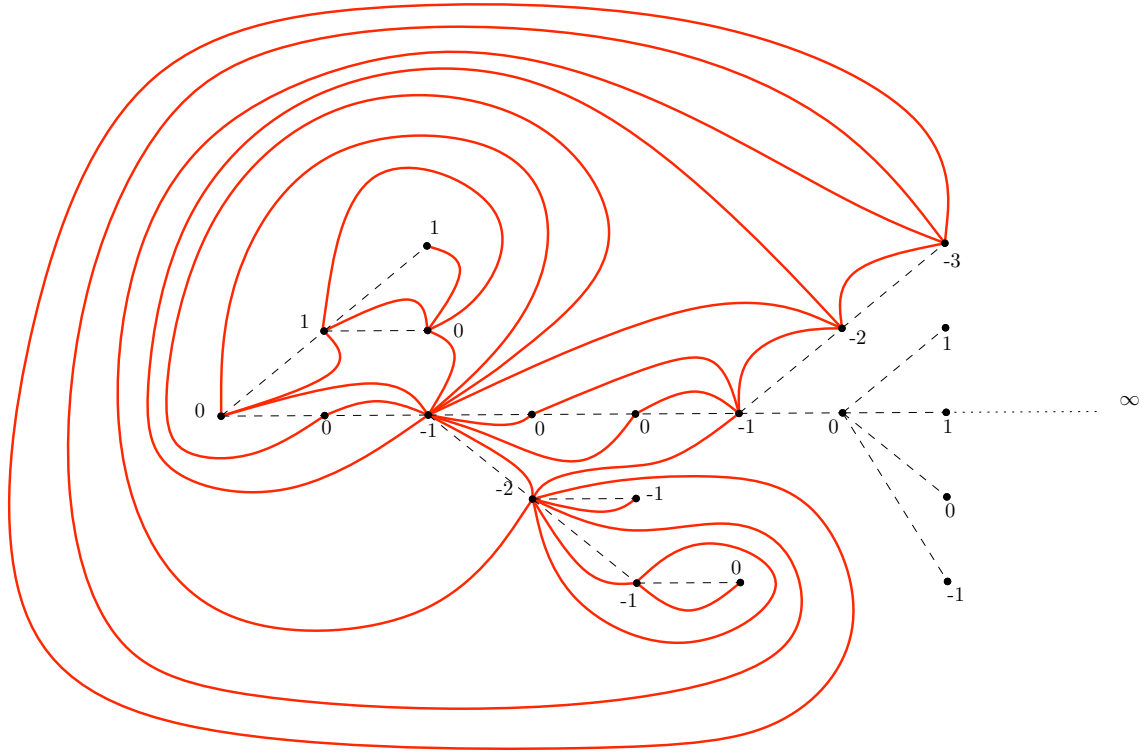

FIGURE 6.3 – Illustration of the Schaeffer correspondence. The tree is represented in dotted lines and the quadrangulation in solid lines.

To prove the continuity of  $\Phi$ , let  $\theta_n = (\tau_n, \ell_n)$  be a sequence in  $\mathcal{S} \cup \mathbf{T}_f^{(0)}$  converging to  $\theta = (\tau, \ell) \in \mathcal{S} \cup \mathbf{T}_f^{(0)}$ . If  $\theta \in \mathbf{T}_f^{(0)}$  then  $\theta_n = \theta$  for every  $n$  large enough, so the fact that  $\Phi(\theta_n) \rightarrow \Phi(\theta)$  is obvious. So let us assume that  $\theta \in \mathcal{S}$ , with spine vertices  $S_\tau(0), S_\tau(1), \dots$ . Let  $R > 0$  be an integer, and let  $l(R)$  be the minimal label of a vertex in  $B_{\mathbf{T}, R}(\theta)$ . Since  $\inf(\ell(S_\tau(i))) = -\infty$ , we can define  $f(R) > R$  as the first  $i \geq 1$  such that  $\ell(S_\tau(i)) = l(R) - 2$ . If  $c$  is a corner in the subtree of  $\tau$  above  $S_\tau(f(R))$ , then the successor of  $c$  cannot be in  $B_{\mathbf{T}, R}(\theta)$ . Indeed, if  $\ell(c) \geq l(R) - 1$  then the successor of  $c$  has to be also in the subtree of  $\tau$  above  $S_\tau(f(R))$ , while if  $\ell(c) < l(R) - 1$ , then this successor also has label  $< l(R) - 1$ , and thus cannot be in  $B_{\mathbf{T}, R}(\theta)$  by definition. Similarly,  $c$  cannot be the successor of any corner in  $B_{\mathbf{T}, R}(\theta)$ , as these successors are necessarily in the subtree of  $\tau$  below  $S_\tau(f(R))$ .

Now, for every  $n$  large enough, it holds that  $B_{\mathbf{T}, f(R)}(\theta_n) = B_{\mathbf{T}, f(R)}(\theta)$ , from which we obtain that the maps formed by the arcs incident to the vertices of  $B_{\mathbf{T}, R}(\theta) = B_{\mathbf{T}, R}(\theta_n)$  are the same, and moreover, no extra arc constructed in  $\theta_n$  or  $\theta$  is incident to a vertex of  $B_{\mathbf{T}, R}(\theta) = B_{\mathbf{T}, R}(\theta_n)$ . Letting  $r > 0$  and choosing  $R$  so that all the edges of  $B_{\mathbf{Q}, r}(\Phi(\theta))$  appear as arcs incident to vertices of  $B_{\mathbf{T}, R}(\theta)$ , we obtain that  $B_{\mathbf{Q}, r}(\Phi(\theta)) = B_{\mathbf{Q}, r}(\Phi(\theta_n))$  for  $n$  large enough. Therefore, we get that  $\Phi(\theta_n) \rightarrow \Phi(\theta)$ , as desired.  $\square$

The vertex set of  $q$  is precisely  $\tau$ , so that the labels  $\ell$  on  $\tau$  induce a labeling of the vertices of  $q$ . In the finite case, we saw earlier in (6.2) that these labels could be recovered from the pointed quadrangulation obtained from a finite labeled tree. In our infinite setting, this is much less obvious : Intuitively the distinguished vertex  $\rho$  of the finite case is “lost at infinity”.

We will see later that when the infinite labeled tree has a special distribution corresponding *via* the Schaeffer correspondence  $\Phi$  to the UIPQ, then the labels have a natural interpretation in terms of distances in the infinite quadrangulation. In general if an infinite quadrangulation  $q$  is constructed from a labeled tree  $\theta = (\tau, \ell)$  in  $\mathcal{S}$ , every pair  $\{u, v\}$  of neighboring vertices in  $q$  satisfies  $|\ell(u) - \ell(v)| = 1$  and thus for every  $a, b \in q$  linked by a geodesic  $a = a_0, a_1, \dots, a_{d_{\text{gr}}^q(a,b)} = b$  we have the crude bound

$$d_{\text{gr}}^q(a, b) = \sum_{i=1}^{d_{\text{gr}}^q(a,b)} |\ell(a_i) - \ell(a_{i-1})| \geq \left| \sum_{i=1}^{d_{\text{gr}}^q(a,b)} \ell(a_i) - \ell(a_{i-1}) \right| = |\ell(a) - \ell(b)|. \quad (6.3)$$

From quadrangulations to trees

We saw that the Schaeffer mapping  $\mathbf{T}_n^{(0)} \times \{0, 1\} \rightarrow \mathbf{Q}_n^\bullet$  is in fact a bijection. We now describe the reverse construction. The details can be found in [43]. Let  $(q, \rho)$  be a finite rooted quadrangulation given with a distinguished vertex  $\rho \in V(q)$ . We define a labeling  $\ell$  of the vertices of the quadrangulation by setting

$$\ell(v) = d_{\text{gr}}^q(v, \rho), \quad v \in V(q).$$

Since the map  $q$  is bipartite, if  $u, v$  are neighbors in  $q$  then  $|\ell(u) - \ell(v)| = 1$ . Thus the faces of  $q$  can be decomposed into two subsets : The faces such that the labels of the vertices listed in clockwise order are  $(i, i + 1, i, i + 1)$  for some  $i \geq 0$  or those for which these labels are  $(i, i + 1, i + 2, i + 1)$  for some  $i \geq 0$ . We then draw on top of the quadrangulation an edge in each face according to the rules given by the figure below.

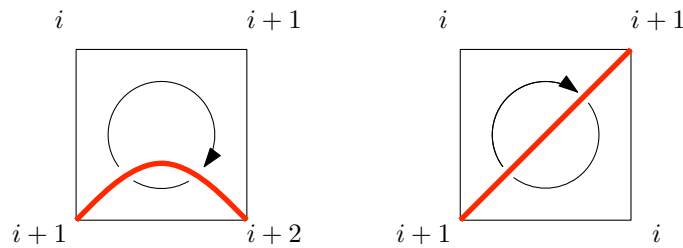

FIGURE 6.4 – Rules for the reverse Schaeffer construction.

The graph  $\tau$  formed by the edges added in the faces of  $q$  is a spanning tree of  $q \setminus \{\rho\}$ , see [43, Proposition 1]. This tree comes with a natural embedding in the plane, and we root  $\tau$  according to the following rules (see Fig.6.5) :

- If  $\ell(e_-^*) > \ell(e_+^*)$  then we root  $\tau$  at the corner incident to the edge  $e^*$  on  $e_-^*$ ,
- otherwise we root  $\tau$  at the corner incident to the edge  $e^*$  on  $e_+^*$ ,

Finally, we shift the labeling of  $\tau$  inherited from the labeling on  $V(q)\setminus\{\rho\}$  by the label of the root of  $\tau$ ,

$$\tilde{\ell}(u) = \ell(u) - \ell(\varnothing), \quad u \in T.$$

Then we have [43, Proposition 1]

$$\Phi^{-1}((q, \rho)) = ((\tau, \tilde{\ell}), \mathbf{1}_{\ell(e_+^*) > \ell(e_-^*)}).$$

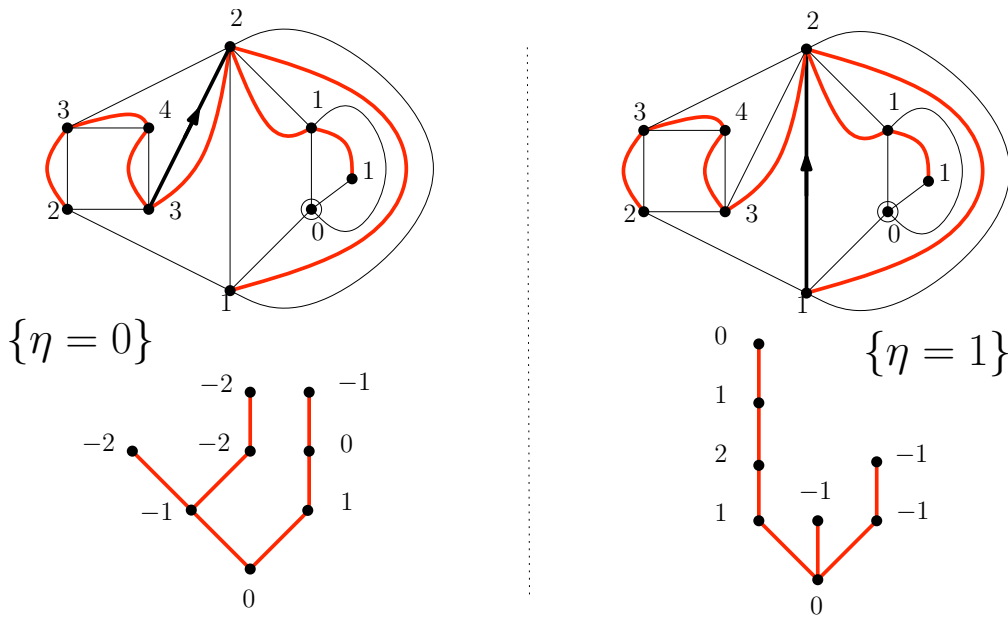

FIGURE 6.5 – Illustration of the rooting of the plane tree  $\tau$

**Infinite case.** If  $q$  is a (possibly infinite) quadrangulation and  $\ell : V(q) \rightarrow \mathbb{Z}$ , is a labeling of the vertices of  $q$  such that for any neighboring vertices  $u, v$  we have  $|\ell(u) - \ell(v)| = 1$ , then a graph can be associated to  $(q, \ell)$  by the device we described above. This graph could contain cycles and is not a tree in the general case.

However, suppose that the infinite quadrangulation  $q$  is constructed as the image under  $\Phi$  of a labeled tree  $\theta = (\tau, \ell) \in \mathcal{S}$  and an element of  $\{0, 1\}$ . Then, with the usual identification of  $V(q)$  with  $\tau$ , the labeling of  $V(q)$  inherited from the labeling  $\ell$  of  $\tau$  satisfies  $|\ell(u) - \ell(v)| = 1$  for any  $u, v \in V(q)$ . An easy adaptation of the argument of [42, Property 6.2] then shows that the faces of  $q$  are in one-to-one correspondence with the edges of  $\tau$  and that the edges constructed on top of each face of  $q$  following the rules of Fig.6.4 exactly correspond to the edges of  $\tau$ . In other words, provided that  $q$  is constructed from  $\theta = (\tau, \ell)$  then the graph constructed on top of  $q$  using the labeling  $\ell$  is exactly  $\tau$ . The rooting of  $\tau$  is also recovered from  $q$  and  $\ell$  by the same procedure as in the finite case.

### 6.2.4 The uniform infinite labeled tree

Let  $\theta = (\tau, \ell) \in \mathcal{S}$ . Recall the notation  $S_\tau(n)$  for the  $n$ th vertex of the spine of  $\theta$ . The trees attached to  $S_\tau(n)$  respectively on the left side and the right side of the spine are denoted by

$$\begin{aligned} L_n(\theta) &= \{v \in \mathcal{U} : S_\tau(n)v \in \tau, S_\tau(n)v \prec S_\tau(n+1)\} \\ R_n(\theta) &= \{v \in \mathcal{U} : S_\tau(n)v \in \tau, S_\tau(n+1) \prec S_\tau(n)v\} \cup \{\emptyset\}, \end{aligned}$$

where  $u \prec v$  denotes the lexicographical order on  $\mathcal{U}$ .

For every integer  $l > 0$  we denote by  $\rho_l$  the law of the Galton-Watson tree with geometric offspring distribution with parameter  $1/2$ , labeled according to the following rules. The root has label  $l$  and every other vertex has a label chosen uniformly in  $\{m-1, m, m+1\}$  where  $m$  is the label of its parent, these choices being made independently for every vertex. Then, for every tree  $\theta \in \mathbf{T}^{(l)}$ ,  $\rho_l(\theta) = \frac{1}{2}12^{-|\theta|}$ .

**Definition 6.6.** Let  $\theta = (T_\infty, (\ell(u))_{u \in T_\infty})$  be a random variable with values in  $(\mathbf{T}^{(0)}, d_{\mathbf{T}})$  whose distribution  $\mu$  is described by the following almost sure properties

1.  $\theta$  belongs to  $\mathcal{S}$ ,
2. the process  $(\ell(S_{T_\infty}(n)))_{n \geq 0}$  is a random walk with independent uniform steps in  $\{-1, 0, 1\}$ ,
3. conditionally given  $(\ell(S_{T_\infty}(n)))_{n \geq 0} = (x_n)_{n \geq 0}$ , the sequence  $(L_n(\theta))_{n \geq 0}$  of subtrees of  $\theta$  attached to the left side of the spine and the sequence  $(R_n(\theta))_{n \geq 0}$  of subtrees attached to the right side of the spine form two independent sequences of independent labeled trees distributed according to the measures  $\rho_{x_n}$ .

In other words, if  $\theta = (T_\infty, \ell)$  is distributed according to  $\mu$  then the structure of the tree  $T_\infty$  is given by an infinite spine and independent critical geometric Galton-Watson trees grafted on the left and right of each vertex of the spine. Conditionally on  $T_\infty$  the labeling is given by independent variables uniform over  $\{-1, 0, +1\}$  assigned to each edge of  $T_\infty$ , which represent the label increments along the different edges, together with the boundary condition  $\ell(\emptyset) = 0$ .

The random infinite tree  $T_\infty$ , called the critical geometric Galton-Watson tree *conditioned to survive*, was constructed in [85, Lemma 1.14] as the limit of critical geometric Galton-Watson conditioned to survive up to level  $n$ , as  $n \rightarrow \infty$ . To make the link between the classical construction of  $T_\infty$  (see e.g. [107, Chapter 12]) and the one provided by the last definition, note the following equality in distribution

$$1 + G + G' \stackrel{(d)}{=} \hat{G},$$

where  $G, G', \hat{G}$  are independent random variables such that  $G, G'$  are geometric of parameter  $1/2$  and  $\hat{G}$  is a size-biased geometric  $1/2$  variable, that is  $\mathbb{P}[\hat{G} = k] = k\mathbb{P}[G = k] = k2^{-(n+1)}$ .

The law  $\mu$  can also be seen as the law of a uniform infinite element of  $\mathcal{S}$ , as formalized by the following statement.

**Theorem 6.7.** *For every  $n \geq 1$ , let  $\mu_n$  be the uniform probability measure on  $\mathbf{T}_n^{(0)}$ . Then the sequence  $(\mu_n)_{n \in \mathbb{N}}$  converges weakly to  $\mu$  in the space of Borel probability measures on  $(\mathbf{T}^{(0)}, d_{\mathbf{T}})$ .*

*Démonstration.* By a standard result, the distribution of a uniformly chosen planar tree  $T_n$  with  $n$  edges is the same as the distribution of a critical Galton-Watson tree with geometric offspring distribution conditioned on the total progeny to be  $n - 1$ , see [97]. The convergence in distribution of  $T_n$  towards  $T_\infty$  in the sense of  $d_{\mathbf{T}}$  then follows from [85, Lemma 1.14], see also [107]. An analogous result holds for the uniform labeled trees since the labeling is given by independent variables uniform over  $\{-1, 0, +1\}$  assigned to each edge of the trees.  $\square$

**Remark 6.8.** *Theorem 6.7 will also follow from the quantitative local convergence of Proposition 6.21.*

### 6.2.5 The main result

We are now ready to state our main result. Recall that  $\nu$  is the law of the UIPQ as defined in Theorem 6.3. Let also  $\mathcal{B}(1/2)$  be the Bernoulli law  $(\delta_0 + \delta_1)/2$ , and recall the Schaeffer correspondence  $\Phi : \mathcal{S} \times \{0, 1\} \rightarrow \mathbf{Q}$ . In the following statement, if  $q$  is an element of  $\mathbf{Q}_\infty$ , and  $f : V(q) \rightarrow \mathbb{R}$  is a function on  $V(q)$ , we say that  $\lim_{z \rightarrow \infty} f(z) = l$  if for every  $\varepsilon > 0$ , there exists  $r \geq 1$  such that for every vertex  $z$  of  $q$  that does not belong to  $B_{\mathbf{Q}, r}(q)$ , it holds that  $|f(z) - l| \leq \varepsilon$ . If  $f$  takes its values in a discrete set, this just means that  $f$  is equal to  $l$  everywhere but on a finite subset of  $V(q)$ .

**Theorem 6.9.** *The probability measure  $\nu$  is the image of  $\mu \otimes \mathcal{B}(1/2)$  under the mapping  $\Phi$  :*

$$\nu = \Phi_*(\mu \otimes \mathcal{B}(1/2)) \tag{6.4}$$

*Moreover, if  $(\theta = (T_\infty, \ell), \eta)$  has distribution  $\mu \otimes \mathcal{B}(1/2)$  and  $Q_\infty = \Phi(\theta, \eta)$ , then, with the usual identification of the vertices of  $Q_\infty$  with the vertices of  $\theta$ , one has, almost surely,*

$$\ell(u) - \ell(v) = \lim_{z \rightarrow \infty} \left( d_{\text{gr}}^{Q_\infty}(u, z) - d_{\text{gr}}^{Q_\infty}(v, z) \right), \quad \forall u, v \in V(Q_\infty). \tag{6.5}$$

Let us make some comments about this result. The first part of the statement is easy : Since  $\Phi$  is continuous from  $(\mathcal{S} \cup \mathbf{T}_f^{(0)}) \times \{0, 1\}$  to  $\mathbf{Q}$  and since, if  $\nu_n$  is the uniform law on  $\mathbf{Q}_n$ , one has

$$\nu_n = \Phi(\mu_n \otimes \mathcal{B}(1/2)),$$

and one obtains (6.4) simply by passing to the limit  $n \rightarrow \infty$  in this identity using Theorems 6.3 and 6.7. To be completely accurate, the mapping  $\Phi$  in the previous display should be understood as taking values in  $\mathbf{Q}_n$  rather than  $\mathbf{Q}_n^\bullet$ , simply by “forgetting” the distinguished vertex arising in the construction of Schaeffer’s bijection.

The rest of the statement is more subtle, and says that the labels, inherited on the vertices of  $Q_\infty$  in its construction from a labeled tree  $(T_\infty, \ell)$  distributed according to  $\mu$ , can be recovered as a measurable function of  $Q_\infty$ . This is not obvious at first, because

a formula such as (6.2) is lacking in the infinite setting. It should be replaced by the asymptotic formula (6.5), which specializes to

$$\ell(u) = \lim_{z \rightarrow \infty} (d_{\text{gr}}^{Q_\infty}(z, u) - d_{\text{gr}}^{Q_\infty}(z, e_\pm^*)), \quad u \in V(Q_\infty), \quad (6.6)$$

where

$$e_\pm^* = \begin{cases} e_-^* & \text{if } \lim_{z \rightarrow \infty} (d_{\text{gr}}^{Q_\infty}(e_-^*, z) - d_{\text{gr}}^{Q_\infty}(e_+^*, z)) = -1 \\ e_+^* & \text{if } \lim_{z \rightarrow \infty} (d_{\text{gr}}^{Q_\infty}(e_-^*, z) - d_{\text{gr}}^{Q_\infty}(e_+^*, z)) = 1 \end{cases}. \quad (6.7)$$

Of course, the fact that the limits in (6.5) and (6.7) exist is not obvious and is part of the statement. This was first observed by Krikun in [90], and will be derived here by different methods. Note that the vertex  $e_\pm^*$  corresponds to the root vertex  $\emptyset$  of  $T_\infty$  in the natural identification of vertices of  $Q_\infty$  with vertices of  $T_\infty$ .

In particular, the fact that the labels are measurable with respect to  $Q_\infty$  entails that  $(\theta, \eta)$  can be recovered as a measurable function of  $Q_\infty$ . Indeed, by the discussion at the end of Section 6.2.3, the tree  $T_\infty$  can be reconstructed from  $Q_\infty$  and the labeling  $\ell$ . The Bernoulli variable  $\eta$  is also recovered by (6.7). This settles the three conjectures proposed by Krikun in [90].

The proof of (6.5) depends on certain properties of geodesics in the UIPQ that we derive in the next section.

### 6.3 Geodesics in the UIPQ

**Geodesics.** If  $G = (V, E)$  is a graph, a *chain* or *path* in  $G$  is a (finite or infinite) sequence of vertices  $\gamma = (\gamma(0), \gamma(1), \dots)$  such that for every  $i \geq 0$ , the vertices  $\gamma(i)$  and  $\gamma(i+1)$  are linked by an edge of the graph. Such a chain is called a *geodesic* if for every  $i, j \geq 0$ , the graph distance  $d_{\text{gr}}^G$  between  $\gamma(i)$  and  $\gamma(j)$  is equal to  $|j - i|$ . A *geodesic ray* emanating from  $x$  is an infinite geodesic starting at  $x \in V$ .

We will establish two properties of the geodesics in the UIPQ : A confluence property towards the root (Section 6.3.1) and a confluence towards infinity (Section 6.3.2). These two properties are reminiscent of the work of Le Gall on geodesics in the Brownian Map [99]. Put together they yield the last part (6.5) of Theorem 6.9.

#### 6.3.1 Confluent geodesics to the root

Let  $Q_\infty$  be distributed according to  $\nu$  (see Theorem 6.3) and  $x$  be a vertex in  $Q_\infty$ . For every  $R \geq 0$ , we want to show that (with probability 1) it is possible to find  $R' \geq R$  and a family of geodesics  $\gamma_R^z, z \notin B_{\mathbf{Q}, R'}(Q_\infty)$  linking  $x$  to  $z$  respectively, such that for every  $z, z' \notin B_{\mathbf{Q}, R'}(Q_\infty)$ ,

$$\gamma_R^z(i) = \gamma_R^{z'}(i), \quad \text{for every } i \in \{0, 1, \dots, R\}.$$

In other words, all of these geodesics start with a common initial segment, independently of the target vertex  $z$ .

To this end, we need another construction of the UIPQ that can be found in [42], which we briefly recall. Let  $l \geq 1$  and set  $\overline{\mathbf{T}}^{(l)}$  be the subset of  $\mathbf{T}^{(l)}$  consisting of those trees  $\theta = (\tau, \ell)$  such that  $\ell(v) \geq 1$  for every  $v \in \tau$ . Elements of  $\overline{\mathbf{T}}^{(l)}$  are called  $l$ -well-labeled tree, and just well-labeled tree if  $l = 1$ . We let  $\overline{\mathbf{T}}_n^{(l)}$  (resp.  $\overline{\mathbf{T}}_\infty^{(l)}$ ) be the set of all  $l$ -well-labeled trees with  $n$  edges (resp. of infinite  $l$ -well-labeled trees).

Let  $\bar{\mu}_n$  be the uniform distribution on  $\overline{\mathbf{T}}_n^{(1)}$ . Let also  $\overline{\mathcal{S}}$  be the set of all trees  $\theta = (\tau, \ell) \in \overline{\mathbf{T}}_\infty^{(1)}$  such that

- the tree  $\tau$  has a unique spine, and
- for every  $R \in \mathbb{N}$ , the set  $\{v \in \tau : \ell(v) \leq R\}$  is finite.

**Proposition 6.10** ([42]). *The sequence  $(\bar{\mu}_n)_{n \geq 1}$  converges weakly to a limiting probability law  $\bar{\mu}$ , in the space of Borel probability measures on  $(\overline{\mathbf{T}}^{(1)}, d_{\mathbf{T}})$ . Moreover, we have  $\bar{\mu}(\overline{\mathcal{S}}) = 1$ .*

The exact description of  $\bar{\mu}$  is not important for our concerns, and can be found in [42]. The Schaeffer correspondence  $\overline{\Phi}$  can be defined on  $\overline{\mathcal{S}}$ . Let us describe quickly this correspondence. Details can be found in [42], see also [101, 111].

Let  $\theta = (\tau, \ell)$  be an element of  $\overline{\mathcal{S}}$ . We start by embedding  $\tau$  in the plane in such a way that there are no accumulation points (which is possible since  $\tau$  is locally finite). We add an extra vertex  $\partial$  in the plane, not belonging to the embedding of  $\tau$ . Then, we let  $(c_i^{(L)}, i \geq 0)$  and  $(c_i^{(R)}, i \geq 0)$  be the sequence of corners visited in contour order on the left and right sides, starting with the root corner of  $\tau$ . We let, for  $i \in \mathbb{Z}$ ,

$$c_i = \begin{cases} c_i^{(L)} & \text{if } i \geq 0 \\ c_{-i}^{(R)} & \text{if } i < 0 \end{cases} .$$

We now define the notion of successor. If the label of  $\mathcal{V}(c_i)$  is 1, then the successor of the corner  $c_i$  is  $\partial$ . Otherwise, the successor of  $c_i$  is the first corner  $c_j$  in the infinite list  $\{c_{i+1}, c_{i+2}, \dots\} \cup \{\dots, c_{i-2}, c_{i-1}\}$  such that  $\ell(c_j) = \ell(c_i) - 1$ . The successor of any corner  $c_i$  with  $\ell(c_i) \geq 2$  exists because of the labeling constraints, and the definition of  $\overline{\mathcal{S}}$ .

The end of the construction is as above : We draw an edge between each corner and its successor and then remove all the edges of the embedding of  $\tau$ . The new edges can be drawn in such a way that the resulting embedded graph is proper and represent an infinite quadrangulation of the plane. We denote this quadrangulation by  $\overline{\Phi}(\theta)$  and root it at the arc from  $\partial$  to  $c_0$ . Note that in this construction, we do not need to introduce an extra parameter  $\eta$  to determine the orientation of the root. Moreover the non-negative labels  $\ell$  have the following interpretation in terms of distances. For every  $u \in \tau$ ,

$$\ell(u) = d_{\text{gr}}^{\overline{\Phi}(\theta)}(\partial, u), \tag{6.8}$$

with the identification of the vertices of  $\overline{\Phi}(\theta)$  with  $\tau \cup \{\partial\}$ .

**Proposition 6.11** ([42],[111]). *It holds that*

$$\nu = \overline{\Phi}_* \bar{\mu},$$

*that is, the UIPQ follows the distribution of  $\overline{\Phi}(\theta)$ , where  $\theta$  is random with distribution  $\bar{\mu}$ .*



It is worth noting that the mapping  $\bar{\Phi} : \bar{\mathcal{S}} \rightarrow \mathbf{Q}$  is injective. Its inverse function  $\bar{\Phi}^{-1} : \bar{\Phi}(\bar{\mathcal{S}}) \rightarrow \bar{\mathbf{T}}^{(1)}$  is described in a similar manner as in Section 6.2.3 : Given the quadrangulation  $q = \bar{\Phi}(\tau, \ell)$ , we recover the labeling  $\ell$  over  $V(q) \setminus \{\partial\}$  by (6.8) and  $\ell(\partial) = 0$ . Note that  $\partial$  is always the origin of the root edge of  $q$ . We then apply the same device as for  $\Phi^{-1}$ , that is, separating the faces of  $q$  into two kinds and adding an edge on top of them according to Fig. 6.4. The resulting graph is  $\tau$  and is rooted at the corner incident to the root edge of  $q$ . One can check that the mapping  $\bar{\Phi}^{-1}$  is continuous. Thus if  $Q_\infty$  is distributed according to  $\mu$ , one can define a labeled tree  $(\tau, \ell)$  distributed according to  $\bar{\mu}$  as a measurable function of  $Q_\infty$  such that  $Q_\infty = \bar{\Phi}(\tau, \ell)$ .

From this construction, it is possible to specify a particular infinite geodesic (or geodesic ray) starting from  $e_-^*$ . Namely, if  $(c_i)_{i \in \mathbb{Z}}$  is the contour sequence of  $\tau$ , for every  $i \geq 1$ , let

$$d(i) = \min\{j \leq 0 : \ell(c_j) = i\}.$$

Then there is an arc between  $c_{d(i+1)}$  and  $c_{d(i)}$  for every  $i \geq 1$ , as well as an arc from  $c_{d(1)}$  to  $\partial$ , and the path  $(\partial, \mathcal{V}(c_{d(1)}), \mathcal{V}(c_{d(2)}), \dots)$  is a geodesic ray. We call it the *distinguished geodesic ray* of  $Q_\infty$ , and denote it by  $\Gamma$ , see Fig. 6.6.

**Lemma 6.12.** *For every  $R \geq 0$ , there exists  $R' \geq R$  such that every  $z \in \mathcal{V}(Q_\infty) \setminus B_{\mathbf{Q}, R'}(Q_\infty)$  can be joined to  $\partial$  by a geodesic chain  $\gamma$  such that  $\gamma(i) = \Gamma(i)$  for every  $i \in \{0, 1, 2, \dots, R\}$ .*

*Démonstration.* Let  $Q_\infty$  be distributed according to  $\nu$  and set  $(\tau, \ell) = \bar{\Phi}^{-1}(Q_\infty)$ . Finally define  $\Gamma$  as above. With the notation introduced before the lemma define

$$R' = \max_{d(R) \leq i \leq g(R)} \ell(c_i),$$

where  $d(R)$  is defined above, and

$$g(i) = \max\{j \geq 0 : \ell(c_j) = i\}.$$

Let  $z$  be a vertex of  $Q_\infty$ , not in  $B_{\mathbf{Q}, R'}(Q_\infty)$ , and let  $c_j$  be any corner incident to  $z$ . Then  $j$  cannot be in  $[d(R), g(R)]$  since by definition  $\ell(c_j) = d_{\text{gr}}^{Q_\infty}(\partial, z) > R' \geq \ell(c_i)$  for any  $i \in [d(R), g(R)]$ . Now, let  $\gamma$  be the geodesic defined as the path starting at  $c_j$ , and following the arcs from  $c_j$  to its successor corner, then from this corner to its successor, and so on until it reaches  $\partial$ . These geodesics have the desired property, see Fig. 6.6. Note that if  $j > 0$ , that is, if  $c_j$  lies on the left side of  $\tau$ , then necessarily all corners in the geodesic  $\gamma$  with label less than or equal to  $R$  have to lie on the right-hand side of  $\tau$ . See Fig. 6.6.  $\square$

### 6.3.2 Coalescence of proper geodesics rays to infinity

With the notation of Theorem 6.9, let  $(\theta = (T_\infty, \ell), \eta)$  be distributed according to  $\mu \otimes \mathcal{B}(1/2)$ , and let  $Q_\infty$  be the image of  $(\theta, \eta)$  by the Schaeffer correspondence  $\Phi$ . The construction of  $Q_\infty$  from  $\theta$  allows to specify another class of geodesic rays in  $Q_\infty$ , which are defined as follows. These geodesic rays are emanating from the root vertex  $\emptyset$  of  $\theta$

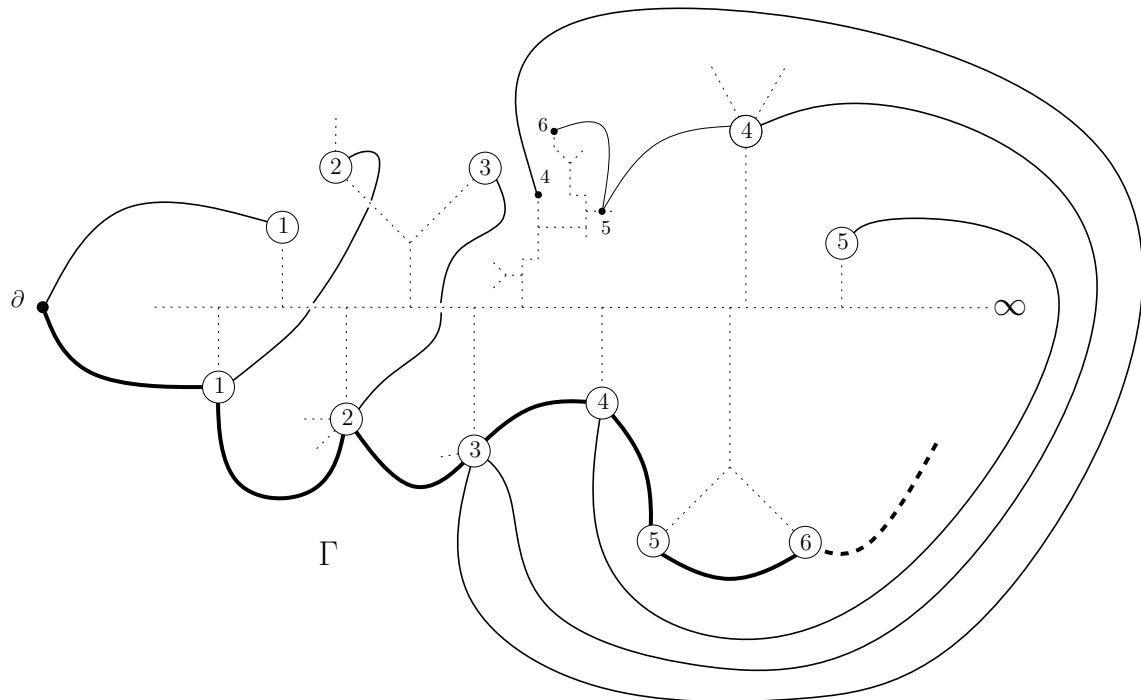

FIGURE 6.6 – Illustration of the proof of Lemma 6.12. The tree is represented in dotted lines. Every vertex marked by a circled integer corresponds to the last occurrence of this integer along either the left or the right side of the tree. The distinguished geodesic  $\Gamma$  is represented by a thick line.

(which can be either  $e_-^*$  or  $e_+^*$ , depending on the value of  $\eta$ ). Consider any infinite path  $(u_0, u_1, u_2, \dots)$  in  $Q_\infty$  starting from  $\emptyset = u_0$ , and such that  $\ell(u_i) = -i$  for every  $i$ . Then necessarily, such a chain is a geodesic ray emanating from  $\emptyset$ , because from (6.3) we have  $d_{\text{gr}}^{Q_\infty}(u_i, u_j) \geq |i - j|$  for every  $i, j \geq 0$ , and the other inequality is obviously true.

We call such a geodesic a *proper* geodesic ray emanating from  $\emptyset$ . We will see later that all geodesic rays emanating from  $\emptyset$  are in fact proper. The main result of this section shows the existence of cut-points which every infinite proper geodesic has to visit.

**Theorem 6.13.** *Let  $(\theta = (T_\infty, \ell), \eta)$  be distributed according to  $\mu \otimes \mathcal{B}(1/2)$ , and let  $Q_\infty$  be the image of  $(\theta, \eta)$  by the Schaeffer correspondence  $\Phi$ . Almost surely, there exists an infinite sequence of distinct vertices  $(p_1, p_2, \dots)$  such that every proper geodesic ray emanating from  $e_+^*$  or  $e_-^*$  passes through  $p_1, p_2, \dots$*

### The maximal and minimal geodesics

To prove Theorem 6.13 we need to introduce two specific proper geodesic rays that are in a sense extremal. Recall that if  $\theta = (\tau, \ell)$  is a labeled tree in  $\mathcal{S}$  with contour sequence  $(c_i)_{i \in \mathbb{Z}}$ , for every  $j \in \mathbb{Z}$  the successor  $\mathcal{S}(c_j)$  of  $c_j$  is the first corner among

$c_{j+1}, c_{j+2}, \dots$  with label  $\ell(c_j) - 1$ .

**Definition 6.14** (maximal geodesic). *Let  $\theta = (\tau, \ell) \in \mathcal{S}$ . For every corner  $c$  of  $\theta$ , the maximal geodesic  $\gamma_{\max}^c$  emanating from  $c$  in  $\theta$  is given by the chain of vertices attached to the iterated successors of  $c$ ,*

$$\gamma_{\max}^c(i) := \mathcal{V}(\mathcal{S}^{(i)}(c)), \quad i \geq 0,$$

where  $\mathcal{S}^{(i)}$  is the  $i$ th fold composition of the successor application.

Using (6.3) again, we deduce that the maximal geodesics are indeed geodesic chains in the quadrangulation associated to  $\theta$ . When  $c = c_0$  is the root corner of  $\tau$  we drop  $c_0$  in the notation  $\gamma_{\max}$  and call it the maximal geodesic. The maximal geodesic is a proper geodesic.

We now also introduce the notion of the minimal geodesic starting from the root. We consider only the left part of an infinite label tree  $(\tau, \ell)$ . The sequence of corners in the clockwise contour of this part of the tree, is denoted by  $(c_0, c_1, c_2, \dots)$ . We define the *minimal geodesic*  $\gamma_{\min}$  inductively : We start from the root  $\emptyset$  of  $\tau$ . Suppose that the first  $n$  steps ( $\emptyset = \gamma_{\min}(0), \dots, \gamma_{\min}(n)$ ) of  $\gamma_{\min}$  have been constructed. Let  $c_j$  be the last corner among  $c_0, c_1, \dots$  that is incident to the vertex  $\gamma_{\min}(n)$ . We then set

$$\gamma_{\min}(n+1) := \mathcal{V}(\mathcal{S}(c_j)).$$

One can check inductively that  $\ell(\gamma_{\min}(i)) = -i$ , thus  $\gamma_{\min}$  is a proper geodesic ray emanating from  $\emptyset$  in  $Q_\infty$ . We restrict the definition of the minimal geodesic to the left part of the tree in order to prescribe the behavior of the path when it hits the spine of the tree. Roughly speaking, the minimal geodesic cannot cross the spine of  $\tau$ .

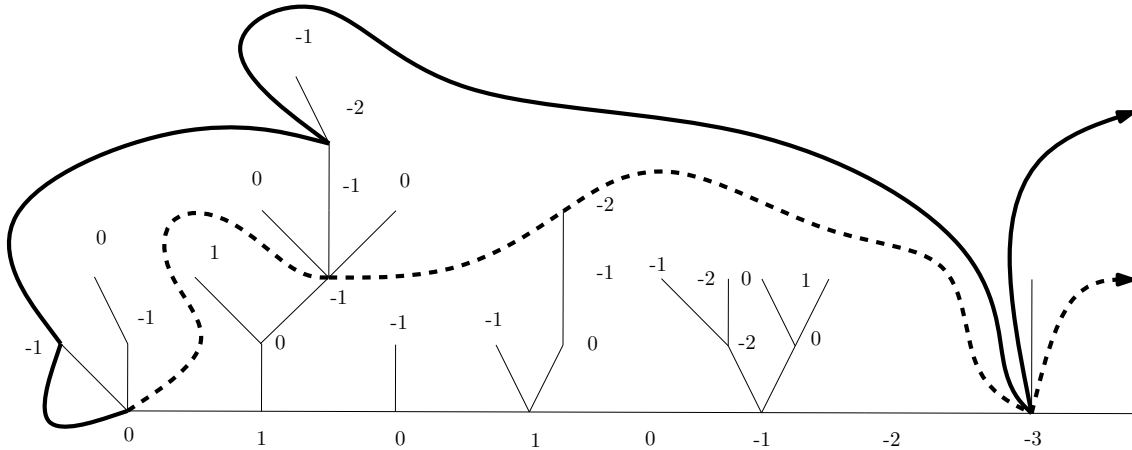

FIGURE 6.7 – The maximal (is solid line) and minimal (in dotted line) geodesics starting from the root corner of the tree  $\theta$ .

It is clear from the construction of  $\gamma_{\min}$  and  $\gamma_{\max}$  that  $\gamma_{\max}$  only visits vertices of subtrees that are attached to  $\gamma_{\min}$ . To be precise, for  $i \geq 0$ , denote by  $A_i$  the labeled tree

consisting of  $\gamma_{\min}(i)$  and its descendants in the left side of the tree  $\tau$  ( $\gamma_{\min}(i)$  might be on the spine). Note that this tree may consist only of the single labeled vertex  $\gamma_{\min}(i)$ . It is clear by construction that  $(A_0, A_1, \dots)$  is an element of  $\prod_{i=0}^{\infty} \mathbf{T}^{(-i)}$ .

**Lemma 6.15.** *The distribution of  $(A_0, A_1, \dots)$  under  $\mu$  is  $\bigotimes_{i=0}^{\infty} \rho_{-i}$ .*

*Proof (Sketch).* Let  $k \geq 0$  be an integer and write  $C_k$  for the subtree of  $T_{\infty}$  between the spine and the first  $k$  steps of  $\gamma_{\min}$ , that is

$$C_k = \left\{ u \in T_{\infty} : \emptyset \preceq u \preceq \gamma_{\min}(k) \text{ and } u \text{ not a strict descendant of } \gamma_{\min}(i) \text{ for } 0 \leq i \leq k \right\}.$$

From the definition of the minimal geodesic, one checks that  $(\gamma_0, \gamma_1, \dots, \gamma_k)$  is a function of the labeled tree  $(C_k, \ell)$ . Let  $(\tau_0, \ell_0)$  be a labeled tree such that  $(C_k, \ell) = (\tau_0, \ell_0)$  with positive probability. Using the definition of the labeling  $\ell$  and standard properties of Galton-Watson trees, it is easy to see that conditionally on  $\{(C_k, \ell) = (\tau_0, \ell_0)\}$  the labeled trees  $A_0, A_1, \dots, A_k$  are distributed according to  $\bigotimes_{i=0}^k \rho_{-i}$ .  $\square$

**Proof of Theorem 6.13**

Let  $\theta = (\tau, \ell)$  be a spatial tree. We set

$$\begin{aligned} \Delta^-(\theta) &= \min\{\ell(u) - \ell(\emptyset) : u \in \theta\}, \\ \Delta(\theta) &= \max\{|\ell(u) - \ell(\emptyset)| : u \in \theta\}. \end{aligned}$$

Before proceeding to the proof of Theorem 6.13 we give a useful lemma which bounds the labels of a tree sampled from  $\rho_0$ .

**Lemma 6.16.** *Let  $l \in \mathbb{Z}$  and let  $\theta = (T, \ell)$  be distributed according to  $\rho_l$ . There exist two constants  $c, C > 0$  such that for every integer  $y \geq 1$*

$$\mathbb{P}(\Delta(\theta) \geq y) \leq Cy^{-2}, \tag{6.9}$$

$$\mathbb{P}(\Delta^-(\theta) \leq -y) \geq cy^{-2}. \tag{6.10}$$

*Démonstration.* Since we are subtracting the label of the root in the definition of  $\Delta$  and  $\Delta^-$ , one can assume without loss of generality that  $\theta = (T, \ell)$  is distributed according to  $\rho_0$ . Let  $y \geq 1$  be an integer. We start with (6.9) and condition on the size  $|\theta|$  of  $\theta$ ,

$$\begin{aligned} \mathbb{P}(\Delta(\theta) \geq y) &= \sum_{n=0}^{\infty} \mathbb{P}(\Delta(\theta) \geq y \mid |\theta| = n) \mathbb{P}(|\theta| = n) \\ &= \sum_{n=0}^{\infty} \mathbb{P}\left(\frac{\Delta(\theta)}{(8n/9)^{1/4}} \geq y \left(\frac{8n}{9}\right)^{-1/4} \mid |\theta| = n\right) \frac{\text{Cat}(n)}{2 \cdot 4^n}, \end{aligned}$$

where we recall the formula  $\mathbb{P}(T = \tau) = 2^{-1-2|\tau|}$  and  $\text{Cat}(n) = \frac{1}{n+1} \binom{2n}{n}$  is the number of planar trees with  $n$  edges. At this point, we use the estimate [43, Proposition 4] to get that the conditional probabilities in the sum are bounded by some constant times

$\exp(-yn^{-1/4})$ . Using the asymptotic behavior of  $\text{Cat}(n)$  as  $n \rightarrow \infty$ , we get that for some constant  $C_1 > 0$  we have

$$\mathbb{P}(\Delta(\theta) \geq y) \leq C_1 \sum_{n=1}^{\infty} e^{-yn^{-1/4}} n^{-3/2}.$$

Using a comparison series-integral one shows that the sum in the right-hand side bounded by  $C_2 y^{-2}$  as  $y \rightarrow \infty$ , which yields (6.9).

Let us turn to (6.10). By Kolmogorov’s estimate [87], there exists  $c_1 > 0$  such that for every  $y \geq 0$  we have  $\mathbb{P}(H(T) \geq y^2) \geq c_1 y^{-2}$ . Conditionally on the event  $\{H(T) \geq y^2\}$ , let  $u_0$  be the first vertex of  $T$  for the contour order such that  $|u_0| = y^2$ . By the definition of the distribution of  $\rho_0$ , the label  $\ell(u_0)$  is given by an  $y^2$ -step random walk with uniform increments over  $\{-1, 0, +1\}$ . Thus by standard properties of random walks, there exists  $c_2 > 0$  such that for every  $y \geq 0$  we have  $\mathbb{P}(\ell(u_0) \leq -y \mid H(T) \geq y^2) > c_2$ . Hence  $\mathbb{P}(\min\{\ell(u) : u \in T\} \leq -y) \geq c_2 c_1 y^{-2}$ . This completes the proof of the lemma.  $\square$

*Proof of Theorem 6.13.* Let  $\theta = (T_\infty, \ell)$  be distributed according to  $\mu$  and let  $\eta$  be an independent Bernoulli variable with parameter  $1/2$ . We assume that  $Q_\infty$  is constructed from  $(\theta, \eta)$ . Note that whatever the value of  $\eta$ , the proper geodesic rays emanating from  $e_+^*$  or  $e_-^*$  are part of proper geodesic rays emanating from  $\emptyset$ , so it suffices to prove the statement for proper geodesic rays emanating from  $\emptyset$ .

As a first step, we start by proving that  $\gamma_{\min}$  and  $\gamma_{\max}$  meet each other infinitely often, almost surely. Recall from the construction of the minimal and maximal geodesics that  $\gamma_{\max}$  visits some of the labeled trees  $(A_i)_{i \geq 0}$  (but not all) grafted on top of  $\gamma_{\min}$ . We write  $0 = \phi(0) < \phi(1) < \phi(2) < \dots$  for the increasing sequence of integers such that  $A_0 = A_{\phi(0)}, A_{\phi(1)}, A_{\phi(2)}, \dots$  are the trees visited by  $\gamma_{\max}$ . The last vertex of  $A_{\phi(k)}$  (for the contour order) visited by  $\gamma_{\max}$  is denoted by  $P_k$ .

**Lemma 6.17.** *The process*

$$D_k = -\phi(k) - \ell(P_k), \quad k \geq 0,$$

*is a homogeneous Markov chain with state space  $\{0, 1, 2, \dots\}$ . Furthermore for every  $y \geq 1$  and  $m \geq 0$  we have*

$$\mathbb{P}(D_{k+1} \geq y \mid D_k = m) \leq C(m+1)y^{-2}, \tag{6.11}$$

*where  $C > 0$  is the constant introduced in (6.9). In particular the Markov chain  $(D_k)_{k \geq 0}$  is recurrent.*

If  $k \geq 0$  is such that  $D_k = 0$  then the geodesics  $\gamma_{\min}$  and  $\gamma_{\max}$  meet each other at  $\gamma_{\min}(\phi(k))$ . Indeed, by the construction of the maximal geodesic, the labels of the points in  $A_{\phi(k)}$  that are visited by  $\gamma_{\max}$  are smaller than or equal to  $-\phi(k)$ , with equality only possible when  $\gamma_{\max}$  visits the root of  $A_{\phi(k)}$ , in which case we must have  $\gamma_{\max}(\phi(k)) = \gamma_{\min}(\phi(k)) = \text{Root}(A_{\phi(k)})$ . The lemma shows that  $D_k = 0$  infinitely often a.s., and thus  $\gamma_{\min}$  and  $\gamma_{\max}$  meet infinitely often, almost surely. This completes the first step.

*Proof of Lemma 6.17.* Suppose that  $D_k = m$  and condition on  $\phi(k)$  and on the subtrees  $A_0, A_1, A_2, \dots, A_{\phi(k)}$ . Recall that the last point visited by  $\gamma_{\max}$  in  $A_{\phi(k)}$  is  $P_k$ . The label of  $P_k$  is  $-m - \phi(k)$ , and  $-\phi(k)$  is the label of the root of  $A_{\phi(k)}$ . By the construction of the maximal geodesic, the next point after  $P_k$  in  $\gamma_{\max}$  must belong to one of the subtrees  $\{A_{\phi(k)+1}, \dots, A_{\phi(k)+m+1}\}$ , because the label of the root of  $A_{\phi(k)+m+1}$  is  $\ell(P_k) - 1$ . In other words we have

$$\phi(k+1) - \phi(k) \leq D_k + 1. \tag{6.12}$$

Conditionally on  $\phi(k)$  and  $A_0, A_1, \dots, A_{\phi(k)}$ , the trees  $(A_{\phi(k)+1}, \dots, A_{\phi(k)+m+1})$  are distributed according to  $\rho_{-\phi(k)-1} \otimes \dots \otimes \rho_{-\phi(k)-m-1}$  by Lemma 6.15. Let  $B_1, \dots, B_{m+1}$  be distributed according to  $\rho_{-1} \otimes \dots \otimes \rho_{-m-1}$ . We denote the first index  $i \in \{1, \dots, m+1\}$  such that  $\min\{\ell(u) : u \in B_i\} \leq -m - 1$  by  $I$  and set  $\tilde{P}$  be the last vertex of  $B_I$  (for the contour order) with minimal label among vertices of  $B_I$ . It is plain that conditionally on  $\{D_k = m\}$ , on  $\phi(k)$  and on  $A_0, A_1, \dots, A_{\phi(k)}$ ,  $D_{k+1}$  has the same distribution as the label of  $\tilde{P}$  minus  $I$ . In particular  $(D_k)$  is a Markov chain. As a corollary of (6.12) we get that  $D_{k+1}$  is less than the maximal displacement of the labels with respect to the root in the trees  $\{A_{\phi(k)+1}, \dots, A_{\phi(k)+m+1}\}$ ,

$$D_{k+1} \leq \max_{1 \leq i \leq m+1} \Delta(A_{\phi(k)+i}).$$

This inequality combined with (6.9) easily yields (6.11). Let us now use these estimates on the transition probabilities of  $(D_k)$  to show that this chain is recurrent. Let  $L$  be the smallest integer such that  $L^{4/3} > C(L+1)$  where  $C$  is the constant introduced in (6.9), note that  $L \geq 1$ . Suppose that  $D_0 = m$  and denote the least integer  $k \geq 0$  such that  $m^{(2/3)^k} \leq L+1$  by  $k_0$ . We consider the event

$$\{D_k \leq m^{(2/3)^k}, \forall k = 0, 1, \dots, k_0\},$$

which is of probability bounded from below by

$$\prod_{i=0}^{k_0-1} \left(1 - C(m^{(2/3)^i} + 1)m^{-2(2/3)^{i+1}}\right).$$

The last product is bounded away from 0 independently of  $m$ . In particular, whatever the starting value  $D_0 = m$ , the Markov chain  $(D_k)$  has a probability greater than some fixed constant  $c_3 > 0$  to make only negative steps until it reaches a level smaller than or equal to  $L+1$ . Since the chain is irreducible, this implies that  $(D_k)$  is recurrent.  $\square$

Let us go back to the proof of Theorem 6.13. Recall that the spine of  $T_\infty$  is denoted by  $(S_{T_\infty}(0), S_{T_\infty}(1), \dots, S_{T_\infty}(n), \dots)$  and the labeled subtree grafted on the left, resp. right, of  $S_{T_\infty}(i)$  is denoted by  $L_i(\theta)$ , resp.  $R_i(\theta)$ . Let  $\lambda \geq 3$  be such that

$$\frac{c}{(5/2)^2} - \frac{C}{(\lambda - 1/2)^2} > 0, \tag{6.13}$$

where  $c$  and  $C$  were introduced in (6.9) and (6.10), and define the event  $E_n$  where the following four conditions hold :

$$\min \{ \ell(S_{T_\infty}(i)) : 0 \leq i \leq 2n^2 \} \in [-n, 0] \tag{6.14}$$

$$\min \{ \ell(v) : v \in R_i(\theta), 0 \leq i \leq n^2 \} \in [-n, 0], \tag{6.15}$$

$$\min \{ \ell(v) : v \in L_i(\theta), 0 \leq i \leq n^2 \} \in [-\lambda n, -2n], \tag{6.16}$$

$$\min \{ \ell(v) : v \in L_i(\theta), n^2 + 1 \leq i \leq 2n^2 \} \in ] -\infty, -2\lambda n]. \tag{6.17}$$

**Proposition 6.18.** *We have  $\inf_{n \geq 1} \mathbb{P}(E_n) > 0$ .*

*Proof of Proposition 6.18.* We begin with condition (6.14), which is easily satisfied. Indeed by standard properties of random walks, the event  $\{ \ell(S_{T_\infty}(i)) \in [-n/2, n/2] : 0 \leq i \leq 2n^2 \}$  has a probability bounded away from 0 independently of  $n$ . We now condition on  $\{ \ell(S_{T_\infty}(i)) \in [-n/2, n/2] : 0 \leq i \leq 2n^2 \}$  and on the values  $(\ell(S_{T_\infty}(i)) : 0 \leq i \leq 2n^2)$ , so that the trees  $L_0(\theta), R_0(\theta), L_1(\theta), R_1(\theta), \dots, L_{2n^2}(\theta), R_{2n^2}(\theta)$  are conditionally independent. The distribution of  $R_i(\theta)$ , resp.  $L_i(\theta)$ , is  $\rho_{\ell(S_{T_\infty}(i))}$ . Condition (6.15) is satisfied if  $\Delta(R_i(\theta)) \leq n/2$  for all  $0 \leq i \leq n^2$ , by (6.9) this event is of probability at least  $(1 - \frac{4C}{n^2})^{n^2+1}$  which is bounded away from 0 independently of  $n$ . Condition (6.16) is satisfied if there exists  $i_0 \in \{0, 1, \dots, n^2\}$  such that

$$-(\lambda - 1/2)n \leq \Delta^-(L_{i_0}) \leq -5n/2 \tag{6.18}$$

and if all trees  $L_i(\theta)$  for  $i \in \{0, 1, \dots, n^2\} \setminus \{i_0\}$  are such that  $\Delta(L_i(\theta)) \leq n$ . Using (6.9) and (6.10) this probability is at least

$$\frac{(n^2 + 1)}{n^2} \left( \frac{c}{(5/2)^2} - \frac{C}{(\lambda - 1/2)^2} \right) \left( 1 - \frac{C}{n^2} \right)^{n^2},$$

which is bounded away from 0 because of (6.13). A similar statement holds for condition (6.17). Since conditionally on  $\{ \ell(S_{T_\infty}(i)) \in [-n/2, n/2] : 0 \leq i \leq 2n^2 \}$  and on the values  $(\ell(S_{T_\infty}(i)))_{0 \leq i \leq 2n^2}$ , the events (6.15), (6.16) and (6.17) are independent we get that  $\mathbb{P}(E_n)$  is bounded away from 0 independently of  $n$ .  $\square$

We also let  $F_n$  be the event that the maximum displacement of the labels of the subtrees  $(A_i, 0 \leq i \leq 2\lambda n)$  is less than  $n^{2/3}$ ,

$$F_n = \{ \Delta(A_i) \leq n^{2/3} : 0 \leq i \leq 2\lambda n \}.$$

By (6.9) and Lemma 6.15, the probability of  $F_n$  converges to 1 as  $n \rightarrow \infty$ . Note that on the event  $F_n$ , since  $D_k \leq \Delta(A_{\phi(k)})$  equation (6.12) implies  $\phi(k+1) - \phi(k) \leq n^{2/3} + 1$  for every  $k$  such that  $\phi(k) \leq 2\lambda n$ . Finally, we set

$$G_n = \{ \exists i : (\lambda + 1)n \leq i \leq (\lambda + 2)n, \gamma_{\min}(i) = \gamma_{\max}(i) \}.$$

A slight adaptation of the calculation at the end of the proof of Lemma 6.17 shows that  $\mathbb{P}(F_n \cap G_n) \rightarrow 1$  as  $n \rightarrow \infty$ .

From now on we argue on  $E_n \cap F_n \cap G_n$  which is an event of probability bounded away from 0 uniformly in  $n$ . Consider the last vertex  $d_n$  visited by the maximal geodesic

in  $\{L_i(\theta), 0 \leq i \leq n^2\}$ . This vertex  $d_n$  has a label which is minimal among labels of vertices in  $\{L_i(\theta), 0 \leq i \leq n^2\}$  and belongs to a subtree  $A_{i_n}$  for a certain integer  $i_n \geq 0$ . By (6.16) we know that  $-\lambda n \leq \ell(d_n) \leq -2n$ , and since  $F_n$  holds we deduce that

$$-\lambda n \leq -i_n = \ell(\gamma_{\min}(i_n)) \leq -2n + n^{2/3}.$$

By (6.14) the labels of the vertices  $S_{T_\infty}(n^2), \dots, S_{T_\infty}(2n^2)$  are larger than or equal to  $-n$ . Consequently  $\gamma_{\min}$  does not hit these vertices. Thanks to this observation the last vertex in  $\{S_{T_\infty}(0), S_{T_\infty}(1), \dots, S_{T_\infty}(2n^2)\}$  visited by  $\gamma_{\min}$  belongs to  $\{S_{T_\infty}(0), S_{T_\infty}(1), \dots, S_{T_\infty}(n^2)\}$ . We denote this vertex by  $\gamma_{\min}(j_n)$ .

Note that if  $\gamma_{\max}$  visits a tree  $A_i$  then  $\gamma_{\min}$  also visits it. Using this, conditions (6.16), (6.17), and the definition of  $F_n$ , one shows that if there exists an integer  $k_n > j_n$  such that  $\gamma_{\min}(k_n)$  is on the spine then necessarily  $k_n \geq 2\lambda n - n^{2/3}$ .

We write  $c$  for the last corner of  $\gamma_{\min}(j_n)$  in the contour of the right-hand side of  $T_\infty$ . This corner thus belongs to the right-hand side of  $T_\infty$ . Now, let  $\gamma_{\max}^c$  be the maximal geodesic starting from  $c$ : This maximal geodesic "surrounds" the trees  $\{R_i(\theta), 0 \leq i \leq l_n\}$  where  $S_{T_\infty}(l_n) = \gamma_{\min}(j_n)$ . Condition (6.15) implies that  $\gamma_{\max}^c$  and  $\gamma_{\max}$  coalesce before the point  $d_n$ . Because we argue on  $G_n$ , there exists a meeting point  $p_\emptyset^1$  of  $\gamma_{\min}$  and  $\gamma_{\max}$  between  $(\lambda + 1)n$  and  $(\lambda + 2)n$  steps along these proper geodesics.

A simple geometric argument then shows that every proper geodesic starting from  $\emptyset$  lies between  $\gamma_{\max}^c$  and  $\gamma_{\min}$  during its first  $2\lambda n - n^{2/3}$  steps. In particular all proper geodesic rays are contained in the gray region represented on Fig. 6.8. The point  $p_\emptyset^1$  is thus a cut-point for all the proper geodesics emanating from  $\emptyset$ , that is a point that every proper geodesic starting from  $\emptyset$  has to visit.

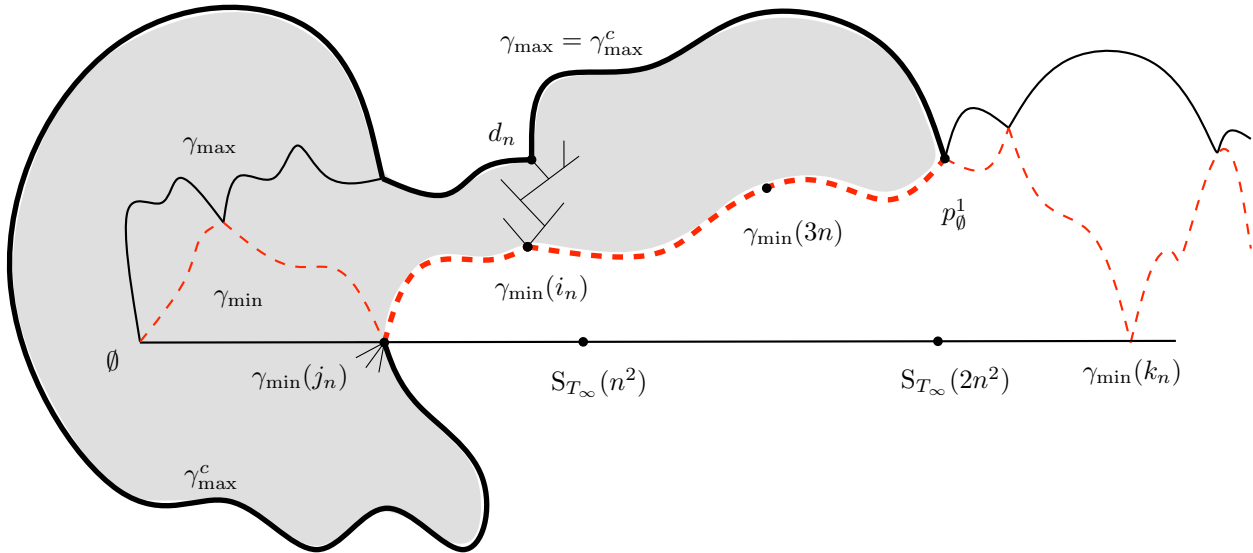

FIGURE 6.8 – Illustration of the proof of Theorem 6.13. The minimal geodesic  $\gamma_{\min}$  is in dotted line. Every proper geodesic emanating from  $\emptyset$  has to stay in the gray region for the first  $2\lambda n - n^{2/3}$  steps.

Summing-up we proved that on the event  $E_n \cap F_n \cap G_n$  which is of probability



bounded away from 0 uniformly in  $n$ , there exists a cut-point at a distance between  $(\lambda + 1)n$  and  $(\lambda + 2)n$  from  $\emptyset$  for all the proper geodesics emanating from  $\emptyset$ .

Although the events  $(E_n)_{n \geq 0}$  are not independent they are *asymptotically* independent, that is for every  $i_0 \in \{0, 1, 2, \dots\}$

$$|\mathbb{P}(E_{i_0} \cap E_n) - \mathbb{P}(E_{i_0})\mathbb{P}(E_n)| \xrightarrow{n \rightarrow \infty} 0.$$

Using the last display and the fact that  $\mathbb{P}(F_n \cap G_n) \rightarrow 1$  as  $n$  goes to  $\infty$ , one shows that almost surely  $E_n \cap F_n \cap G_n$  occurs infinitely often. We leave the details to the reader.  $\square$

We propose the following question. A positive answer would simplify the proof of Theorem 6.13.

**Question 10.** *Is it true that a.s.  $\gamma_{\min}(n)$  does not belong to the spine for all large enough  $n$  ?*

**Question 11** (Presumably easier). *Is it true that a.s.  $\gamma_{\max}(n)$  does not belong to the spine for all large enough  $n$  ?*

### 6.3.3 End of the proof of Theorem 6.9

**Lemma 6.19.** *Almost surely, the function  $z \mapsto d_{\text{gr}}^{Q_\infty}(z, e_-^*) - d_{\text{gr}}^{Q_\infty}(z, e_+^*)$  from  $V(Q_\infty)$  to  $\{-1, 1\}$  is almost constant., i.e. is constant except for finitely many  $z \in Q_\infty$ .*

*Démonstration.* This statement is a property of the UIPQ, but for the purposes of the proof, we will assume that  $Q_\infty$  is constructed from a tree  $\theta = (T_\infty, \ell)$  with law  $\mu$  and an independent parameter  $\eta$  with  $\mathcal{B}(1/2)$  distribution, by applying the Schaeffer correspondence  $\Phi$ . This allows to specify the class of proper geodesic rays among all geodesic rays.

First, let us assume that  $\emptyset = e_-^*$ , meaning that  $\eta = 0$ . Let  $\gamma_{\max}$  be the maximal geodesic so that  $\gamma_{\max}(0) = \emptyset = e_-^*$ , and  $\gamma_{\max}(1) = e_+^*$ . It is also a proper geodesic ray, so that  $\ell(\gamma_{\max}(i)) = -i$  for every  $i$ .

Note that if  $\gamma$  is a geodesic from  $\emptyset$  to  $\gamma_{\max}(i)$  for some  $i \geq 0$ , then necessarily  $\ell(\gamma(j)) = -j$  for every  $j \in \{0, 1, 2, \dots, i\}$ , the reason being that the labels of two neighboring vertices in  $Q_\infty$  differ by at most 1.

Now let  $\Gamma$  be the distinguished geodesic ray which starts from  $e_-^* = \emptyset$  constructed from  $Q_\infty$  by first recovering the Chassaing-Durhuus tree  $(\tau, \ell) = \Phi^{-1}(Q_\infty)$  and then constructing  $\Gamma$  as we did just before Lemma 6.12, and let  $R \geq 0$ . Applying Lemma 6.12, we obtain the existence of  $R' \geq R$  such that the vertex  $\gamma_{\max}(R' + 1)$ , which does not belong to  $B_{\mathbb{Q}, R'}(Q_\infty)$ , can be linked to  $\emptyset$  by a geodesic  $\gamma$  such that  $\gamma(i) = \Gamma(i)$  for  $i \in \{0, 1, \dots, R\}$ . Since  $\ell(\gamma(R' + 1)) = \ell(\gamma_{\max}(R' + 1)) = -(R' + 1)$ , we deduce from the above discussion that  $\ell(\gamma(i)) = -i$  for every  $i \in \{0, 1, \dots, R'\}$ , so in particular,  $\ell(\Gamma(i)) = -i$  for every  $i \in \{0, 1, \dots, R\}$ . Since  $R$  was arbitrary, we deduce that the distinguished geodesic  $\Gamma$  is proper.

By Theorem 6.13, we get that  $\Gamma$  and  $\gamma_{\max}$  meet infinitely often. In particular, for every  $\alpha \in (0, 1)$ , we can find  $R = R(\alpha)$  such that with probability at least  $1 - \alpha$ , there

exists  $I \in \{1, 2, \dots, R\}$  such that  $\Gamma(I) = \gamma_{\max}(I)$ . From now on we argue on this event. Applying Lemma 6.12 again, we can find  $R'$  such that for every  $z \in V(Q_\infty) \setminus B_{\mathbf{Q}, R'}(Q_\infty)$ , one can link  $\emptyset$  to  $z$  by a geodesic  $\gamma$  whose  $R'$  first steps coincide with those of  $\Gamma$ . But since  $\Gamma(I) = \gamma_{\max}(I)$ , we can replace the first  $I$  steps of  $\gamma$  by those of  $\gamma_{\max}$ , and obtain a new geodesic from  $\emptyset$  to  $z$ , whose first step goes from  $e_-^*$  to  $e_+^*$ . Since this holds for any  $z$  at distance at least  $R' + 1$  from  $e_-^*$ , we obtain that  $d_{\text{gr}}^{Q_\infty}(z, e_-^*) - d_{\text{gr}}^{Q_\infty}(z, e_+^*) = 1$  for every  $z$  at distance at least  $R' + 1$  from  $e_-^*$ . Since  $\alpha$  was arbitrary, we obtain the desired result in the case  $\eta = 0$ .

To treat the case  $\eta = 1$ , we use the obvious fact that if  $\overleftarrow{Q}_\infty$  is the same quadrangulation as  $Q_\infty$ , but where the root edge has the reverse orientation, then  $\overleftarrow{Q}_\infty$  has the same distribution as  $Q_\infty$ . Moreover,  $\overleftarrow{Q}_\infty = \Phi(\theta, 1 - \eta)$  so on the event  $\{\eta = 1\}$  we are back to the situation  $\eta = 0$  by arguing on  $\overleftarrow{Q}_\infty$  instead of  $Q_\infty$ .  $\square$

From this, it is easy to prove (6.5), which will complete the proof of Theorem 6.9. Indeed, if  $x$  and  $y$  are neighboring vertices in  $Q_\infty$  we can pick an edge  $e$  such that  $e_- = x$  and  $e_+ = y$ . By Proposition 6.26 below, the quadrangulation  $Q_\infty^{(e)}$  re-rooted at  $e$  has the same almost sure properties as  $Q_\infty$ . In particular, almost surely the function  $z \mapsto d(x, z) - d(y, z)$  is almost constant. But by reasoning on every step of a chain from  $x$  to  $y$ , the same holds for any  $x, y \in Q_\infty$ . This constant has to be  $\ell(x) - \ell(y)$ . Indeed let us consider  $\gamma_x$  and  $\gamma_y$  two maximal geodesics emanating from a corner associated to  $x$  resp.  $y$ . From properties of the Schaeffer construction, these two geodesics merge at some point  $x = \gamma_x(i) = \gamma_y(i + \ell(y) - \ell(x))$  for some  $i \in \{0, 1, 2, \dots\}$ , and  $\gamma_x(j) = \gamma_y(j + \ell(y) - \ell(x))$  for every  $j \geq i$ . Hence

$$\lim_{z \rightarrow \infty} d_{\text{gr}}^{Q_\infty}(x, z) - d_{\text{gr}}^{Q_\infty}(y, z) = \lim_{\substack{z \rightarrow \infty \\ z \in \gamma_x \cap \gamma_y}} d_{\text{gr}}^{Q_\infty}(x, z) - d_{\text{gr}}^{Q_\infty}(y, z) = \ell(x) - \ell(y).$$

**Corollary 6.20.** *Every geodesic ray emanating from  $\emptyset$  is proper.*

*Démonstration.* Let  $\gamma$  be a geodesic ray and let  $i_0 \geq 1$  fixed. Applying (6.6) we get

$$\begin{aligned} \ell(\gamma(i_0)) &= \lim_{z \rightarrow \infty} \left( d_{\text{gr}}^{Q_\infty}(\gamma(i_0), z) - d_{\text{gr}}^{Q_\infty}(\emptyset, z) \right) \\ &= \lim_{i \rightarrow \infty} \left( d_{\text{gr}}^{Q_\infty}(\gamma(i_0), \gamma(i)) - d_{\text{gr}}^{Q_\infty}(\emptyset, \gamma(i)) \right). \end{aligned}$$

On the other hand, since  $\gamma$  is a geodesic, for  $i \geq i_0$  we have  $d_{\text{gr}}^{Q_\infty}(\gamma(i_0), \gamma(i)) = i - i_0$ , which implies that  $\ell(\gamma(i_0)) = -i_0$ . This allows to conclude since  $i_0$  was arbitrary.  $\square$

## 6.4 Applications

In this section, we use the representation of the UIPQ given by Theorem 6.9 in order to deduce new results on this object. In particular, the comparison of scaling limits of the UIPQ with the Brownian map [98, 102] enables us to solve a question of Krikun about separating cycles in the UIPQ. In the last section, we study simple random walk on the UIPQ through the labeling  $\ell$ .

### 6.4.1 Local limit *versus* scaling limit

In order to compare large balls in the UIPQ with balls in large uniform random quadrangulations, we first establish a quantitative version of the convergence of Theorem 6.7. Roughly speaking, for any  $h \geq 0$  the tree  $B_{\mathbf{T},h}(T_\infty)$  formed by the first  $h$  generations in the tree  $T_\infty$  becomes close in distribution to  $B_{\mathbf{T},h}(T_{\lfloor \lambda h^2 \rfloor})$  when  $\lambda \rightarrow \infty$ , where  $T_{\lfloor \lambda h^2 \rfloor}$  is uniformly distributed over the set of all planar trees with  $\lfloor \lambda h^2 \rfloor$  edges. This comparison is easier to handle if we deal with *pointed* trees.

#### Quantitate convergence of trees

A *pointed* tree is a pair  $(\tau, o)$  where  $\tau$  is a rooted planar tree and  $o$  is a vertex of  $\tau$ . For any  $0 < h < |o|$  we denote by  $\mathcal{P}(\tau, o, h)$  the subtree of  $\tau$  consisting of all vertices  $u$  such that the common ancestor of  $u$  and  $o$  is at height strictly less than  $h$ , together with the ancestor  $o_{(h)}$  of  $o$  at height exactly  $h$ . We then define the pointed tree

$$\mathcal{P}^\bullet(\tau, o, h) = (\mathcal{P}(\tau, o, h), o_{(h)}).$$

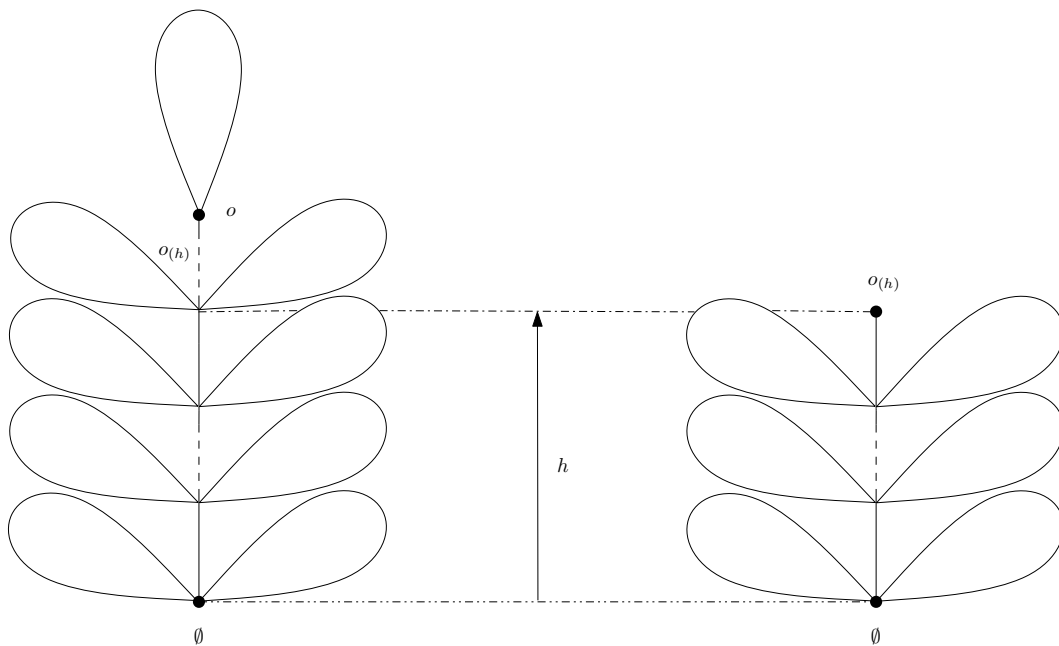

FIGURE 6.9 – A pruned rooted tree  $(\tau, o)$  and the resulting pruned tree  $\mathcal{P}^\bullet(\tau, o, h)$ .

By convention when  $h \geq |o|$ , the pointed tree  $\mathcal{P}^\bullet(\tau, o, h)$  is  $(\{\emptyset\}, \emptyset)$ . If  $\tau \in \mathcal{S}$ , recall that we denote the vertices forming the spine of  $\tau$  by  $S_\tau(0), S_\tau(1), \dots$ . We add an extra point  $S_\tau(\infty)$  to  $\tau$  which roughly speaking corresponds to a point at the extremity of the spine of  $\tau$ . We then extend the definition of  $\mathcal{P}(\tau, o, h)$  to any tree  $\tau \in \mathcal{S}$  and  $o = S_\tau(\infty)$  :  $\mathcal{P}(\tau, S_\tau(\infty), h)$  is the subtree of  $\tau$  consisting of the spine  $S_\tau(0), \dots, S_\tau(h)$

up to height  $h$  and the subtrees  $L_i(\tau)$  and  $R_i(\tau)$  for  $0 \leq i \leq h - 1$ . We also set  $\mathcal{P}^\bullet(\tau, S_\tau(\infty), h) = (\mathcal{P}(\tau, S_\tau(\infty), h), S_\tau(h))$ .

In the following,  $T_n$  is uniformly distributed over the set of all rooted planar trees with  $n$  edges, and conditionally on  $T_n$ ,  $o_n$  is a vertex of  $T_n$  chosen uniformly at random. In particular if  $t_0$  is a fixed tree with  $n$  edges and  $o$  a vertex of  $t_0$ , we have

$$\mathbb{P}((T_n, o_n) = (t_0, o)) = \frac{1}{\text{Cat}(n)(n+1)} = \frac{\binom{2n}{n}}{(n+1)^2}.$$

Let  $T_\infty$  be a uniform infinite planar tree. The following proposition relates  $T_n$  to  $T_\infty$ .

**Proposition 6.21.** *For any  $\varepsilon > 0$  there exist  $\delta > 0$  and  $n_0 \geq 0$  such that for  $n \geq n_0$  we have*

$$\left| \mathbb{P}\left(\mathcal{P}^\bullet\left(T_n, o_n, \lfloor \delta n^{1/2} \rfloor\right) \in A\right) - \mathbb{P}\left(\mathcal{P}^\bullet\left(T_\infty, S_{T_\infty}(\infty), \lfloor \delta n^{1/2} \rfloor\right) \in A\right) \right| \leq \varepsilon,$$

for any finite set  $A$  of pointed trees. Consequently, if  $k_n = o(n^{1/2})$  then the total variation distance between  $\mathcal{P}^\bullet(T_n, o_n, k_n)$  and  $\mathcal{P}^\bullet(T_\infty, S_{T_\infty}(\infty), k_n)$  goes to 0 as  $n$  goes to  $\infty$ .

**Remark 6.22.** *This theorem implies the local convergence of  $T_n$  towards  $T_\infty$ .*

**Remark 6.23.** *Note that a similar result has been proved by Aldous [2, Theorem 2] for Poisson Galton-Watson trees.*

*Démonstration.* Let  $h \geq 1$  be an integer. We first identify the distribution of the variable  $\mathcal{P}^\bullet(T_\infty, S_{T_\infty}(\infty), h)$ . Recall that  $\mathcal{P}(T_\infty, S_{T_\infty}(\infty), h)$  consists of by the fragment of the spine in  $\tau$  up to height  $h$ , together with the subtrees grafted to the left and to the right of it up to level  $h - 1$ . This tree is pointed at  $S_{T_\infty}(h)$ . Let  $(t_0, o)$  be a pointed tree where  $o$  is a vertex of  $t_0$  at height  $h$  without children (of the form of the right-hand side of Fig. 6.9). Using the fact that the subtrees grafted on the spine of  $\tau$  are independent Galton-Watson trees with geometric offspring distribution of parameter  $1/2$  we easily get

$$\mathbb{P}(\mathcal{P}^\bullet(T_\infty, S_{T_\infty}(\infty), h) = (t_0, o)) = 4^{-|t_0|}. \tag{6.19}$$

We also get that the number  $|\mathcal{P}(T_\infty, S_{T_\infty}(\infty), h)|$  of edges of the random pointed tree  $\mathcal{P}^\bullet(T_\infty, S_{T_\infty}(\infty), h)$  is given by the sum of  $2h$  independent variables

$$N_{0,l}, N_{0,r}, \dots, N_{h-1,l}, N_{h-1,r},$$

where  $N_{i,l}$ , resp.  $N_{i,r}$ , is the number of edges in the subtree grafted on the left, resp. right, of the  $i$ th node of the spine plus  $1/2$  (to take into account the edges on the spine up to level  $h$ ). In particular for each  $i \geq 0$ ,  $N_{i,l} - 1/2$  is distributed according to the size of a Galton-Watson tree with geometric offspring distribution of parameter  $1/2$ . It follows that for  $n \geq 0$ ,

$$\mathbb{P}(N_{0,l} = n + 1/2) = \frac{1}{2} \text{Cat}(n) 4^{-n} \underset{n \rightarrow \infty}{\sim} \frac{n^{-3/2}}{2\sqrt{\pi}}. \tag{6.20}$$

Standard facts about domains of attractions (see for example [28, p. 343-350]) imply that  $n^{-2}|\mathcal{P}(T_\infty, S_{T_\infty}(\infty), n)|$  converges in distribution towards a multiple of a stable law with parameter  $1/2$ . It follows that there exists  $C_3 > 0$  such that for  $n$  large enough

$$\mathbb{P}\left(C_3^{-1}n \leq |\mathcal{P}(T_\infty, S_{T_\infty}(\infty), \lfloor \sqrt{n} \rfloor)| \leq C_3 n\right) \geq 1 - \varepsilon. \quad (6.21)$$

We now compute the distribution of  $\mathcal{P}^\bullet(T_n, o_n, h)$ . Fix a tree  $t_0$  distinct from  $\{\emptyset\}$  with less than  $n - 1$  edges and a vertex  $o$  at height  $h$  in  $t_0$  with no offspring. The event  $\{\mathcal{P}^\bullet(T_n, o_n, h) = (t_0, o)\}$  holds if and only if the tree  $T_n$  is obtained from the tree  $t_0$  by grafting at  $o$  a subtree  $\mathfrak{t}$  having  $n - |t_0|$  edges. Furthermore, the distinguished point  $o_n$  of  $T_n$  must lie in  $\mathfrak{t}$  but should be different from its root. Hence a direct counting argument shows that

$$\mathbb{P}(\mathcal{P}^\bullet(T_n, o_n, h) = (t_0, o)) = \frac{\text{Cat}(n - |t_0|)(n - |t_0|)}{\text{Cat}(n)(n + 1)} \underset{\substack{n - |t_0| \rightarrow \infty \\ |t_0| \rightarrow \infty}}{\sim} 4^{-|t_0|} \left(1 - \frac{|t_0|}{n}\right)^{-1/2} \quad (6.22)$$

We deduce from (6.19) and (6.22) that if  $n$  is large enough then for every pointed tree  $(t_0, o)$  such that  $C_3^{-1}n \leq |t_0| \leq C_3 n$ , then for every integer  $\kappa \geq 2C_3$  and  $m \geq \kappa n$  we have

$$\left(1 - \frac{2C_3}{\kappa}\right)^{1/2} \leq \frac{\mathbb{P}(\mathcal{P}^\bullet(T_\infty, \infty, \lfloor \sqrt{n} \rfloor) = (t_0, o))}{\mathbb{P}(\mathcal{P}^\bullet(T_m, o_m, \lfloor \sqrt{n} \rfloor) = (t_0, o))} \leq 1.$$

Fix  $\varepsilon > 0$  and choose  $\kappa \in \mathbb{Z}_+$  such that  $(1 - 2C_3/\kappa)^{1/2} \geq 1 - \varepsilon$ . The inequality in the last display, together with (6.21), shows that for every  $n$  sufficiently large and every  $m \geq \kappa n$ , we have for every set of pointed trees  $A$

$$\left| \mathbb{P}\left(\mathcal{P}^\bullet(T_m, o_m, \lfloor \sqrt{n} \rfloor) \in A\right) - \mathbb{P}\left(\mathcal{P}^\bullet(T_\infty, S_{T_\infty}(\infty), \lfloor \sqrt{n} \rfloor) \in A\right) \right| \leq 4\varepsilon,$$

which completes the proof of the proposition. □

### Quantitative convergence of maps

The last proposition has a corollary in terms of maps. Let  $Q_n$  be uniformly distributed over the set of rooted quadrangulations with  $n$  edges and  $Q_\infty$  be the uniform infinite planar quadrangulation. Recall that we denote the combinatorial ball of radius  $r \geq 0$  around the origin  $e_-^*$  of the distinguished edge of a rooted quadrangulation  $q$  by  $B_{\mathbf{Q}, r}(q)$ .

**Corollary 6.24.** *For any  $\varepsilon > 0$ , there exist  $\delta > 0$  and  $n_0 \geq 0$  such that for  $n \geq n_0$  we have*

$$\left| \mathbb{P}\left(B_{\mathbf{Q}, \lfloor \delta n^{1/4} \rfloor}(Q_n) \in A\right) - \mathbb{P}\left(B_{\mathbf{Q}, \lfloor \delta n^{1/4} \rfloor}(Q_\infty) \in A\right) \right| \leq \varepsilon,$$

for any finite set  $A$  of quadrangulations with holes. Consequently, if  $k_n = o(n^{1/4})$  then the total variation distance between  $B_{\mathbf{Q}, k_n}(Q_n)$  and  $B_{\mathbf{Q}, k_n}(Q_\infty)$  goes to 0 when  $n \rightarrow \infty$ .

*Proof of Corollary 6.24.* Let  $\theta_n = (T_n, (\ell_n(u))_{u \in T_n})$  be uniform over  $\mathbf{T}_n^{(0)}$  and let  $\theta_\infty = (T_\infty, (\ell(u))_{u \in T_\infty})$  be distributed according to  $\mu$ . Fix  $\eta \in \{0, 1\}$ . We write  $Q_\infty = \Phi(\theta_\infty, \eta)$  and  $Q_n$  for the rooted quadrangulation with  $n$  faces obtained from  $\Phi(\theta_n, \eta)$  after forgetting the pointed vertex. Conditionally on  $(T_n, \ell)$  pick a uniform vertex  $o_n$  of  $T_n$ . Finally, let  $\varepsilon > 0$  and choose  $\delta > 0$  and  $n_0 \geq 0$  such that the first assertion of Proposition 6.21 holds.

If  $S_{T_\infty}(0), S_{T_\infty}(1), \dots$  denotes the spine of  $T_\infty$ , let  $m_n \in \{0, 1, \dots, \lfloor \delta n^{1/2} \rfloor\}$  be such that

$$\ell(S_{T_\infty}(m_n)) = \min \{ \ell(S_{T_\infty}(i)), 0 \leq i \leq \lfloor \delta n^{1/2} \rfloor \}.$$

We also set  $M_n = -\ell(S_{T_\infty}(m_n))$ . We claim that there exists  $\delta' > 0$  small enough so that for large all sufficiently large  $n$

$$\mathbb{P}(M_n \geq \lfloor \delta' n^{1/4} \rfloor + 4) \geq 1 - \varepsilon. \tag{6.23}$$

Indeed,  $-M_n$  is the minimal value of a one dimensional random walk starting from 0 with increments uniform in  $\{-1, 0, +1\}$  and stopped at  $\lfloor \delta n^{1/2} \rfloor$ . Then (6.23) follows from standard properties of random walks.

Let us assume that  $M_n \geq 4$ , which holds with a probability tending to 1 as  $n \rightarrow \infty$ . We denote the first corner associated with the vertex  $S_{T_\infty}(m_n)$  in the left, resp. right, contour of the tree  $T_\infty$  by  $c_1$ , resp.  $c_2$ . The corner  $c_1$  belongs to the left part of  $T_\infty$  and the corner  $c_2$  belongs to the right part of  $T_\infty$ . Consider the two maximal geodesics  $\gamma_{\max}^{c_1}$  and  $\gamma_{\max}^{c_2}$  starting respectively from  $c_1$  and  $c_2$ . Then  $\gamma_{\max}^{c_1}$  and  $\gamma_{\max}^{c_2}$  eventually coalesce. Notice that every vertex of  $\gamma_{\max}^{c_1} \cup \gamma_{\max}^{c_2}$  has a label smaller than  $-M_n$  thus is at distance greater than  $M_n$  from  $\emptyset$  by (6.3). A simple geometric argument using Jordan’s theorem shows that any path in  $Q_\infty$  joining  $\emptyset$  to a vertex  $u \in T_\infty \setminus \mathcal{P}(T_\infty, S_{T_\infty}(\infty), \lfloor \delta n^{1/2} \rfloor)$  has to meet  $\gamma_{\max}^{c_1} \cup \gamma_{\max}^{c_2}$ , in particular  $d_{\text{gr}}^{Q_\infty}(\emptyset, u) \geq M_n$ . Since we have  $d_{\text{gr}}^{Q_\infty}(\emptyset, e_-^*) \leq 1$ , every vertex  $u \in T_\infty \setminus \mathcal{P}(T_\infty, S_{T_\infty}(\infty), \lfloor \delta n^{1/2} \rfloor)$  satisfies  $d_{\text{gr}}^{Q_\infty}(u, e_-^*) \geq M_n - 1$ . Henceforth, all the edges of the map  $B_{\mathbf{Q}, M_n - 4}(Q_\infty)$  are arcs drawn between two vertices of  $\mathcal{P}(T_\infty, S_{T_\infty}(\infty), \lfloor \delta n^{1/2} \rfloor)$  which implies that  $B_{\mathbf{Q}, M_n - 4}(Q_\infty)$  is a function of the labeled tree  $(\mathcal{P}(T_\infty, S_{T_\infty}(\infty), \lfloor \delta n^{1/2} \rfloor), \ell)$ . By comparing the constructions of  $Q_n$ , resp.  $Q_\infty$ , from the trees  $\theta_n$ , resp.  $\theta_\infty$ , and  $\eta \in \{0, 1\}$  we deduce that if

$$(\mathcal{P}^\bullet(T_\infty, S_{T_\infty}(\infty), \lfloor \delta n^{1/2} \rfloor), \ell) = (\mathcal{P}^\bullet(T_n, o_n, \lfloor \delta n^{1/2} \rfloor), \ell_n)$$

then

$$B_{\mathbf{Q}, M_n - 4}(Q_\infty) = B_{\mathbf{Q}, M_n - 4}(Q_n).$$

The corollary is then a consequence of the above discussion, (6.23) and Proposition 6.21 which is easily extended to labeled trees.  $\square$

### Separating cycles

The last corollary enables us to connect the large scale properties of the UIPQ to properties of large random maps. As an application we deduce the non-existence of sub-linear separating cycles in the UIPQ from the homeomorphism theorem of Le Gall and Paulin [102]. This was conjectured by Krikun in [89].

Recall that a cycle in a graph  $G$  is a chain  $\mathcal{C}$  of neighboring vertices  $x_0, x_1, \dots, x_p = x_0$  in  $G$ . The length  $L(\mathcal{C})$  of  $\mathcal{C}$  is the number of vertices of  $\mathcal{C}$ . In the case of the UIPQ, we say that a cycle  $\mathcal{C}$  separates the origin from infinity, if  $e_-^*$  lies in a finite component of  $Q_\infty \setminus \mathcal{C}$ . Krikun has proved [89, Section 3.5] that for every integer  $n \geq 1$ , there exists a cycle  $\mathcal{C}_n$  separating the origin from infinity satisfying

- $n \leq \inf \{ d_{\text{gr}}^{Q_\infty}(e_-^*, v) : v \in \mathcal{C}_n \} \leq \sup \{ d_{\text{gr}}^{Q_\infty}(e_-^*, v) : v \in \mathcal{C}_n \} \leq 2n,$
- $n^{-1} \mathbb{E}[L(\mathcal{C}_n)] \rightarrow 11$  as  $n \rightarrow \infty$ .

**Corollary 6.25.** *Let  $\kappa > 1$  and let  $\theta : \mathbb{N} \rightarrow \mathbb{R}_+$  be a function such that  $\theta(n) = o(n)$  as  $n \rightarrow \infty$ . The probability that there exists an injective cycle  $\mathcal{C}_n$  separating the origin from infinity in  $Q_\infty$  such that*

- $n \leq \inf \{ d_{\text{gr}}^{Q_\infty}(e_-^*, v) : v \in \mathcal{C}_n \} \leq \sup \{ d_{\text{gr}}^{Q_\infty}(e_-^*, v) : v \in \mathcal{C}_n \} \leq \kappa n,$
- $L(\mathcal{C}_n) \leq \theta(n),$

*tends to 0 as  $n \rightarrow \infty$ .*

*Démonstration.* Fix  $\varepsilon > 0$ , and let  $0 < \delta < 1$  be small enough so that Corollary 6.24 holds. Set  $m = \lceil \left(\frac{2\kappa n}{\delta}\right)^4 \rceil$ . For large values of  $n$  the total variation distance between the distribution of the ball of radius  $2\kappa n$  around the origin in a rooted quadrangulation uniform over  $\mathbf{Q}_m$  and the distribution of the ball of radius  $2\kappa n$  around the origin in  $Q_\infty$  is smaller than or equal to  $\varepsilon$ . In particular, the probability that there exists an injective cycle  $\mathcal{C}_n$  in  $Q_\infty$  such that

- $L(\mathcal{C}_n) \leq \theta(n),$
- $n \leq \inf \{ d_{\text{gr}}^{Q_\infty}(e_-^*, v) : v \in \mathcal{C}_n \} \leq \sup \{ d_{\text{gr}}^{Q_\infty}(e_-^*, v) : v \in \mathcal{C}_n \} \leq \kappa n,$
- every component of  $B_{\mathbf{Q}, 2\kappa n}(Q_\infty) \setminus \mathcal{C}_n$  has diameter larger than  $n,$

is within distance  $\varepsilon$  of the similar probability involving  $Q_m$ . Note that the third condition is always fulfilled in the case of  $Q_\infty$ . The upper bound on the distance from the root of a cycle imposed in the second condition implies that, in the case of  $Q_m$ , the third condition can be checked by looking only at  $B_{\mathbf{Q}, 2\kappa n}(Q_m)$ . Thanks to [102, Corollary 1.2] (see also [116]) the last probability goes to 0 as  $n \rightarrow \infty$ . This completes the proof of the corollary.  $\square$

We can also ask for a stronger version of the last result where the direct comparison principle with the Brownian Map does not work as easily.

**Question 12.** *Let  $\theta : \mathbb{N} \rightarrow \mathbb{R}_+$  be a function such that  $\theta(n) = o(n)$  as  $n \rightarrow \infty$ . Does the probability that there exists an injective cycle  $\mathcal{C}_n$  separating the origin from infinity in  $Q_\infty$  such that*

- $n \leq \inf \{ d_{\text{gr}}^{Q_\infty}(e_-^*, v) : v \in \mathcal{C}_n \},$
- $L(\mathcal{C}_n) \leq \theta(n),$

*tends to 0 as  $n \rightarrow \infty$ ?*

### 6.4.2 Random walk on the UIPQ

#### Invariance under re-rooting along the random walk

Let  $q$  be a rooted quadrangulation, which can be finite or infinite. We consider the nearest-neighbor random walk on  $q$  starting from  $e_+^*$ . Rather than the random sequence

of vertices visited by this walk, we really want to emphasize the sequence of edges that are visited. Formally, we consider a random infinite sequence of oriented edges  $(E_0, E_1, E_2, \dots)$  starting with the root edge  $E_0 = e^*$  and defined recursively as follows. Conditionally given  $(E_i, 0 \leq i \leq j)$ , we let  $E_{j+1}$  be a random edge pointing from  $(E_j)_+$ , chosen uniformly among the  $\text{deg}((E_j)_+)$  possible ones. The sequence  $((E_{1+i})_-, i \geq 0)$  is then the usual nearest-neighbor random walk on  $V(q)$ , starting from  $e_+^*$ .

We let  $P_q$  be the law of the sequence  $(E_i, i \geq 0)$ <sup>1</sup>. Also, for any oriented edge  $e$  of the map  $q$ , we let  $q^{(e)}$  be the map  $q$  re-rooted at  $e$ . Finally, if  $\lambda$  is a probability distribution on  $\mathbf{Q}$ , let  $\Theta^{(r)}(\lambda)$  be the probability distribution defined by

$$\Theta^{(r)}(\lambda)(A) = \int_{\mathbf{Q}} \lambda(q) \int P_q(d(e_0, e_1, e_2, \dots)) \mathbf{1}_{q^{(e_r)} \in A},$$

for any Borel subset  $A$  of  $\mathbf{Q}$ . The probability measure  $\Theta^{(r)}(\lambda)$  is the distribution of a random map with distribution  $\lambda$ , re-rooted at the  $r$ th step of the random walk.

**Proposition 6.26.** *The law  $\nu$  of the UIPQ is invariant under re-rooting along a simple random walk, in the sense that for every  $r \geq 0$ , one has  $\Theta^{(r)}(\nu) = \nu$ .*

Moreover, if  $A$  is an event of the Borel  $\sigma$ -algebra of  $(\mathbf{Q}, d_{\mathbf{Q}})$  such that  $\nu(A) = 1$ , then

$$\nu\left(\left\{q \in \mathbf{Q} : \forall e \in \vec{E}(q), q^{(e)} \in A\right\}\right) = 1.$$

See [7, 17] for a general study of random graphs that are invariant under re-rooting along the simple random walk. In the case of the UIPQ, the first assertion of Proposition 6.26 appears in [90, Section 1.3], see also [11, Theorem 3.2] for a similar result in the case of the UIPT. We provide a detailed proof for the sake of completeness.

*Démonstration.* It is easy to see that the function  $\Theta^{(r)}$  on the set  $\mathcal{P}(\mathbf{Q})$  of Borel probability measures on  $(\mathbf{Q}, d_{\mathbf{Q}})$  coincides with the  $r$ -fold composition of  $\Theta = \Theta^{(1)}$  with itself. Therefore, it suffices to show the result for  $r = 1$ .

Let us check that  $\Theta$  is continuous when  $\mathcal{P}(\mathbf{Q})$  is endowed with the topology of weak convergence. Indeed, if  $\lambda_n$  converges weakly to  $\lambda$  as  $n \rightarrow \infty$ , then by the Skorokhod representation theorem, we can find a sequence  $(Q_n, n \geq 0)$  of random variables in  $\mathbf{Q}$  with respective laws  $(\lambda_n, n \geq 0)$ , that converges a.s. to a random variable  $Q$  with law  $\lambda$ . For every fixed  $R > 0$ , it then holds that  $B_{\mathbf{Q},R}(Q_n) = B_{\mathbf{Q},R}(Q)$  for every  $n$  large enough a.s.. Now, we can couple in an obvious way the random walks with laws  $P_{Q_n}$  and  $P_Q$ , in such a way that the first step  $E_1$  is the same edge in  $Q_n$  and  $Q$  on the event where  $B_{\mathbf{Q},1}(Q_n) = B_{\mathbf{Q},1}(Q)$ . For such a coupling, we then obtain that  $B_{\mathbf{Q},R-1}(Q_n^{(E_1)}) = B_{\mathbf{Q},R-1}(Q^{(E_1)})$  for every  $n$  large enough. Since  $R$  is arbitrary, this shows that  $Q_n^{(E_1)}$  converges a.s. to  $Q^{(E_1)}$ , so that  $\Theta(\lambda_n)$  converges weakly to  $\Theta(\lambda)$ , as desired.

---

1. Recall that a map is an equivalence class of embedded graphs, so the last definition does not really make sense but the reader can check that all quantities computed in the sequel do not depend on a representative embedded graph of the map.



Since we know by Theorem 6.3 that the uniform law  $\nu_n$  on  $\mathbf{Q}_n$  converges to  $\nu$ , it suffices to show that  $\Theta(\nu_n) = \nu_n$ . Now consider the law of the doubly-rooted map  $(q, e^*, e_1)$  under the law  $\nu_n(q)P_q((e_i)_{i \geq 0})$ . The probability that  $(q, e^*, e_1)$  equals a particular doubly-rooted map  $(q, e', e'')$  with  $e'_+ = e''_-$  is equal to  $(\#\mathbf{Q}_n \deg(e'_+))^{-1}$ , from which it immediately follows that  $(q, e_*, e_1)$  has the same distribution as  $(q, \overleftarrow{e}_1, \overleftarrow{e}_*)$ , still under  $\nu_n(q)P_q((e_i)_{i \geq 0})$ . Hence  $(q, \overleftarrow{e}_1)$  under  $\nu_n(q)P_q((e_i)_{i \geq 0})$  has the same law  $\nu_n$  as  $(q, e_*)$ . Since  $\nu_n$  is obviously invariant under the reversal of the root edge, we get that  $(q, e_1)$  has law  $\nu_n$ . But by definition, it also has law  $\Theta(\nu_n)$ , which gives the first assertion of Proposition 6.26.

Let us now prove the last part of the statement of the proposition. By the first part, we have

$$\int_{\mathbf{Q}} \nu(dq) E_q \left[ \sum_{n=0}^{\infty} \mathbf{1}_{A^c}(q^{(e_n)}) \right] = 0.$$

Thus,  $\nu(dq)$  a.s. ,  $E_q[\sum_{n=0}^{\infty} \mathbf{1}_{A^c}(q^{(e_n)})] = 0$ . But

$$E_q \left[ \sum_{n=0}^{\infty} \mathbf{1}_{A^c}(q^{(e_n)}) \right] \geq \sum_{e \in \vec{E}(q)} P_q(\exists n \geq 0 : e_n = e) \mathbf{1}_{A^c}(q^{(e)}),$$

and  $P_q(\exists n \geq 0 : e_n = e) > 0$  for every  $e \in \vec{E}(q)$  because  $q$  is connected. This completes the proof.  $\square$

**Remark 6.27.** *It can seem a little unnatural to fix the first step of the random walk to be equal to  $e^*$ , hence to be determined by the rooted map  $q$  rather than by some external source of randomness. In fact, we could also first re-root the map at some uniformly chosen random edge incident to  $e^*$ , and start the random walk with this new edge. Since the first re-rooting leaves the laws  $\nu_n, \nu$  invariant, as is easily checked along the same lines as the previous proof, the results of Proposition 6.26 still hold with the new random walk.*

### On recurrence

Let  $Q_\infty$  be the uniform infinite planar quadrangulation. Conditionally on  $Q_\infty$ ,  $(E_k)_{k \geq 0}$  denotes the random sequence of oriented edges with  $E_0 = e^*$  traversed by a simple random walk on  $Q_\infty$  as discussed at the beginning of Section 6.4.2. We write  $X_k = (E_k)_-$  for the sequence of vertices visited along the walk. For  $k \geq 0$ , we denote the quadrangulation  $Q_\infty$  re-rooted at the oriented edge  $E_k$  by  $Q_\infty^{(k)}$ . Proposition 6.26 shows that  $Q_\infty^{(k)}$  has the same distribution as  $Q_\infty$ .

**Question 13** ([11]). *Is the simple random walk  $(X_k)_{k \geq 0}$  on  $Q_\infty$  almost surely recurrent?*

A similar question for UIPT arose when Angel & Schramm [11] introduced this infinite random graph. These questions are still open. Steffen Rohde and James T. Gill [72] proved that the Riemann surface obtained from the UIPQ by gluing squares along

edges is recurrent for Brownian motion. The first author and Itai Benjamini also proved that the UIPQ is almost surely Liouville [17]. However the lack of a bounded degree property for the UIPQ prevents one from deducing recurrence from these results (see also [21]). Our new construction of the UIPQ however leads to some new information suggesting that the answer to the above Question should be positive.

**Theorem 6.28.** *The process  $(\ell(X_n))_{n \geq 0}$  is a.s. recurrent, i.e. visits every integer infinitely often.*

*Démonstration.* For every  $k \geq 0$ , one can consider the labeling  $(\ell^{(k)}(u))_{u \in Q_\infty}$  of the vertices of  $Q_\infty$  that corresponds to the labeling given by Theorem 6.9 applied to the rooted infinite planar quadrangulation  $Q_\infty^{(k)}$ . On the one hand, it is straightforward to see from (6.5) that  $\ell^{(k)}(u) - \ell^{(k)}(v) = \ell(u) - \ell(v)$  for every  $u, v \in Q_\infty$ . On the other hand, applying Proposition 6.26 we deduce that the process  $(\ell^{(k)}(X_{k+i}) - \ell^{(k)}(X_k))_{i \geq 0}$  has the same distribution as  $(\ell(X_i) - \ell(X_0))_{i \geq 0}$ . Gathering up the pieces, we deduce that for every integer  $k \geq 0$  we have

$$(\ell(X_i) - \ell(X_0))_{i \geq 0} \stackrel{(d)}{=} (\ell(X_{k+i}) - \ell(X_k))_{i \geq 0}. \tag{6.24}$$

Hence the increments  $(\ell(X_{i+1}) - \ell(X_i))_{i \geq 0}$  form a stationary sequence. Furthermore, we have  $|\ell(X_1) - \ell(X_0)| = 1$ , and since the distribution of  $Q_\infty$  is preserved when reversing the orientation of the root edge we deduce

$$\ell(X_1) - \ell(X_0) \stackrel{(d)}{=} \ell(X_0) - \ell(X_1) \stackrel{(d)}{=} \mathcal{B}(1/2).$$

In particular the increments of  $\ell(X_n)$  have zero mean. Suppose for an instant that the increments of  $\ell(X_n)$  were also ergodic, then Theorem 3 of [53] would directly apply and give the recurrence of  $\ell(X_n)$ . Although the UIPQ is ergodic, a proof of this fact would take us too far, so we will reduce the problem to the study of ergodic components.

By standard facts of ergodic theory, the law  $\xi$  of the sequence of increments  $(\ell(X_{i+1}) - \ell(X_i))_{i \geq 0}$  can be expressed as a barycenter of ergodic probability measures in the sense of Choquet, namely for every  $A \subset \mathcal{B}(\mathbb{R})^{\otimes \mathbb{N}}$  we have

$$\xi(A) = \int \zeta(A) dm(\zeta), \tag{6.25}$$

where  $m$  is a probability measure on the set of all probability measures on  $(\mathbb{R}^{\mathbb{N}}, \mathcal{B}(\mathbb{R})^{\otimes \mathbb{N}}, \mathbb{P})$  that are ergodic for the shift. In our case, it suffices to show that  $m$ -almost every  $\zeta$  satisfies the assumption of [53, Theorem 3]. Specializing (6.25) with  $A_1 = \{(y_i)_{i \geq 0} : |y_{i+1} - y_i| \leq 1, \forall i \geq 0\}$  we deduce that  $m$ -almost every  $\zeta$ , we have  $\zeta(A_1) = 1$ , in particular the increments under  $\zeta$  are integrable. It remains to show that they have zero mean.

**Lemma 6.29.** *Almost surely we have*

$$\lim_{n \rightarrow \infty} \frac{\ell(X_n)}{n} = 0.$$

*Démonstration.* In [42, Theorem 6.4] it is shown that  $\mathbb{E}[\#B_{\mathbf{Q},r}(Q_\infty)] \leq C_3 r^4$  where  $C_3 > 0$  is independent of  $r \geq 1$ . Using the Borel-Cantelli lemma we easily deduce that

$$\lim_{r \rightarrow \infty} r^{-6} \#B_{\mathbf{Q},r}(Q_\infty) = 0, \quad a.s. \quad (6.26)$$

We now use the classical Varopoulos-Carne upper bound (see for instance Theorem 13.4 in [107]) : we have

$$p_n(e_+^*, x) \leq 2 \sqrt{\frac{\deg(x)}{\deg(e_+^*)}} \exp\left(-\frac{d_{\text{gr}}^{Q_\infty}(e_+^*, x)^2}{2n}\right), \quad (6.27)$$

where conditionally on  $Q_\infty$ ,  $p_n(\cdot, \cdot)$  is the  $n$ -step transition probability of the simple random walk started from  $e_+^*$  in  $Q_\infty$ . Conditionally on  $Q_\infty$ , using a crude bound  $\deg(x) \leq \#B_{\mathbf{Q},n+1}(Q_\infty)$  on the degree of a vertex  $x \in B_{\mathbf{Q},n}(Q_\infty)$ , we have using (6.27)

$$P_{Q_\infty}(X_n \notin B_{\mathbf{Q},n^{2/3}}(Q_\infty)) \leq 2 \exp\left(-\frac{n^{1/3}}{2}\right) (\#B_{\mathbf{Q},n+1}(Q_\infty))^{3/2}.$$

Hence on the event  $\{\lim_{r \rightarrow \infty} r^{-6} \#B_{\mathbf{Q},r}(Q_\infty) = 0\}$ , an easy application of the Borel-Cantelli lemma shows that  $n^{-1} d_{\text{gr}}^{Q_\infty}(X_n, \emptyset) \rightarrow 0$  as  $n \rightarrow \infty$ . Since  $|\ell(X_n)| \leq d_{\text{gr}}^{Q_\infty}(X_n, \emptyset)$ , the above discussion together with (6.26) completes the proof of the lemma.  $\square$

Let us complete the proof of Theorem 7.16. We can specialize formula (6.25) to  $A_2 = \{(y_i)_{i \geq 0} : \lim i^{-1}|y_i| = 0\}$ , to obtain that  $m$ -a.e  $\zeta$  we have  $\zeta(A_2) = 1$ . Using the ergodic theorem that means that the increments under  $\zeta$  are centered. We can thus apply Theorem 3 of [53] to get that for  $m$ -almost every  $\zeta$ , the process whose increments are distributed according to  $\zeta$  is recurrent, hence  $(\ell(X_n))$  is almost surely recurrent.  $\square$

## Appendix

### Embeddings

In this section, we explain how the elements of  $\mathbf{Q}_\infty$  can be seen as infinite quadrangulations of a certain non-compact surface.

Recall that an element  $q$  of  $\mathbf{Q}_\infty$  is a sequence of compatible maps with holes  $(q_1, q_2, \dots)$ , in the sense that  $q_r = B_{\mathbf{Q},r}(q_{r+1})$ . This sequence defines a unique cell complex  $S_q$  up to homeomorphism, with an infinite number of 2-cells, which are quadrangles. This cell complex is an orientable, connected, separable topological surface, and every compact connected sub-surface is planar.

It is known [124] that the topology of  $S_q$  is characterized by its *ends space*, which is a certain totally disconnected compact space. Roughly speaking, the ends space determines the different “points at infinity” of the surface. More precisely, following [124], we define a boundary component of  $S_q$  as a sequence  $(U_1, U_2, \dots)$  of subsets of  $S_q$ , such that

- for every  $i \geq 1$ , the set  $U_i$  is unbounded, open, connected and with compact boundary,

- for every  $i \geq 1$ , it holds that  $U_{i+1} \subset U_i$ ,
- for every bounded subset  $A \subset S_q$ ,  $U_i \cap A = \emptyset$  for every  $i$  large enough.

Two boundary components  $(U_i, i \geq 1)$ ,  $(U'_i, i \geq 1)$  are called equivalent if for every  $i \geq 1$  there exists  $i' \geq 1$  such that  $U'_{i'} \subset U_i$ , and vice-versa. An *end* is an equivalence class of boundary components. For every  $U \subset S_q$  with compact boundary, we let  $V_U$  be the set of all ends whose corresponding boundary components are sequences of sets which are eventually included in  $U$ . The topological space having the sets  $V_U$  as a basis is called the ends space, and denoted by  $\mathcal{E}_q$ .

Conversely, it is plain that every rooted quadrangulation of an orientable, connected, separable, non-compact planar surface, defines an element of  $\mathbf{Q}_\infty$ , by taking the sequence of the balls centered at the root vertex, with the same definition as in Section 6.2.2. The separability ensures that the collection of balls exhausts the whole surface. Thus we have :

**Proposition 6.30.** *The elements of  $\mathbf{Q}_\infty$  are exactly the quadrangulations of orientable, connected, separable, non-compact planar surfaces, and considered up to homeomorphisms that preserve the orientation.*

To understand better what the ends space is in our context, note that there is a natural tree structure  $\mathcal{T}_q$  associated with  $q \in \mathbf{Q}_\infty$ . The vertices  $v$  of this tree are the holes of  $q_1, q_2, q_3, \dots$ , and an edge links the vertices  $v$  and  $v'$  if there exists an  $r \geq 1$  such that  $v$  is a hole of  $q_r$ ,  $v'$  is a hole of  $q_{r+1}$ , and  $v'$  is included in the face determined by  $v$ . Furthermore, all the holes in  $q_1$  are linked by an edge to an extra root vertex.

It is then easy to see that  $\mathcal{E}_q$  is homeomorphic to the ends space  $\partial\mathcal{T}_q$  which is defined as follows :  $\partial\mathcal{T}_q$  is just the set of infinite injective paths (spines) in  $\mathcal{T}_q$  starting from the root, and a basis for its topology is given by the sets  $W_v$  made of the spines that pass through the vertex  $v$  of  $\mathcal{T}_q$ . (This is consistent, since it is easy and well-known that the ends space of trees with finite degrees is a compact totally disconnected space.)

In particular, when  $\mathcal{T}_q$  has a unique spine, then  $\mathcal{E}_q$  is reduced to a point, which means that the topology of  $S_q$  is that of the plane  $\mathbb{R}^2$ .

### Gromov compactification

Let  $(X, d)$  be a locally compact metric space. The set  $C(X)$  of real-valued continuous functions on  $X$  is endowed with the topology of uniform convergence on every compact set of  $X$ . One defines an equivalence relation on  $C(X)$  by declaring two functions equal if they differ by a constant and the associated quotient space endowed with the quotient topology is denoted by  $C(X)/\mathbb{R}$ . Following [74], one can embed the original space  $X$  in  $C(X)/\mathbb{R}$  using the mapping

$$i : x \in X \mapsto d_x = d(x, \cdot) \in C(X) \mapsto \overline{d_x} \in C(X)/\mathbb{R}.$$

The Gromov compactification of  $X$  is then the closure of  $i(X)$  in  $C(X)/\mathbb{R}$ . The boundary  $\partial X$  of  $X$  is composed of the points in  $\mathcal{C}(i(X)) \setminus i(X)$ , where  $\mathcal{C}(\cdot)$  denotes the closure in  $C(X)/\mathbb{R}$ . The points in  $\partial X$  are called *horofunctions*, see [74].

In the case where  $(X, d)$  is a locally finite countable graph  $G$  endowed with the graph distance  $d_{\text{gr}}^G(.,.)$ , the above description is a bit easier and still makes sense. Theorem 6.9 can be rephrased in this context :

**Theorem 6.31.** *Almost surely, the Gromov boundary  $\partial Q_\infty$  of the UIPQ consists of only one point which is  $\bar{\ell}$ , the equivalence class of  $\ell$  up to additive constants.*

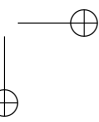
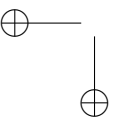
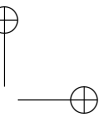
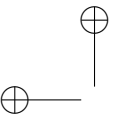

PARTIE

3

---

Racine de dix-sept moins  
trois sur deux

---

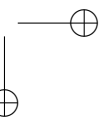
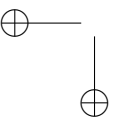
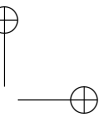
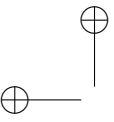



# The Random Recursive Triangulation of the Disk via Fragmentation Theory

---

LES RÉSULTATS DE CE CHAPITRE ONT ÉTÉ OBTENUS EN COLLABORATION AVEC JEAN-FRANÇOIS LE GALL ET ONT ÉTÉ ACCEPTÉS POUR PUBLICATION DANS *The Annals of Probability*.

We introduce and study an infinite random triangulation of the unit disk that arises as the limit of several recursive models. This triangulation is generated by throwing chords uniformly at random in the unit disk and keeping only those chords that do not intersect the previous ones. After throwing infinitely many chords and taking the closure of the resulting set, one gets a random compact subset of the unit disk whose complement is a countable union of triangles. We show that this limiting random set has Hausdorff dimension  $\beta^* + 1$ , where  $\beta^* = (\sqrt{17} - 3)/2$ , and that it can be described as the geodesic lamination coded by a random continuous function which is Hölder continuous with exponent  $\beta^* - \varepsilon$ , for every  $\varepsilon > 0$ . We also discuss recursive constructions of triangulations of the  $n$ -gon that give rise to the same continuous limit when  $n$  tends to infinity.

## 7.1 Introduction

In this work, we use fragmentation theory to study an infinite random triangulation of the unit disk that arises as the limit of several recursive models. Let us describe a special case of these models in order to introduce our main object of interest. We consider a sequence  $U_1, V_1, U_2, V_2, \dots$  of independent random variables, which are uniformly distributed over the unit circle  $\mathbb{S}_1$ . We then construct inductively a sequence  $L_1, L_2, \dots$  of random closed subsets of the (closed) unit disk  $\mathbb{D}$ . To begin with,  $L_1$  just consists of the chord with endpoints  $U_1$ , and  $V_1$ , which we denote by  $[U_1V_1]$ . Then at step  $n + 1$ , we consider two cases. Either the chord  $[U_{n+1}V_{n+1}]$  intersects  $L_n$ , and we put  $L_{n+1} = L_n$ . Or the chord  $[U_{n+1}V_{n+1}]$  does not intersect  $L_n$ , and we put  $L_{n+1} = L_n \cup [U_{n+1}V_{n+1}]$ . Thus, for every integer  $n \geq 1$ ,  $L_n$  is a disjoint union of random chords. We then let

$$L_\infty = \overline{\bigcup_{n=1}^{\infty} L_n}$$

be the closure of the (increasing) union of the sets  $L_n$ . See Fig.1 below for a simulation of the set  $L_\infty$ .

The closed set  $L_\infty$  is a geodesic lamination of the unit disk, in the sense that it is a closed union of non-crossing chords (here we say that two chords do not cross if they do not intersect except possibly at their endpoints). We refer to [30] for the general notion of a geodesic lamination of a surface in the setting of hyperbolic geometry. We may also view  $L_\infty$  as an infinite triangulation of the unit disk, in the same sense as in Aldous [6]. Precisely,  $L_\infty$  is a closed subset of  $\overline{\mathbb{D}}$ , which has zero Lebesgue measure and is such that any connected component of  $\overline{\mathbb{D}} \setminus L_\infty$  is a triangle whose vertices belong to the circle  $\mathbb{S}_1$ . The latter properties are not immediate, but will follow from forthcoming statements.

In order to state our first result, let us introduce some notation. We denote by  $N(L_n)$  the number of chords in  $L_n$ . Then, for every  $x, y \in \mathbb{S}_1$ , we let  $H_n(x, y)$  be the number of chords in  $L_n$  that intersect the chord  $[xy]$ . We also set

$$\beta^* = \frac{\sqrt{17} - 3}{2}.$$

**Theorem 7.1.** (i) *We have*

$$n^{-1/2} N(L_n) \xrightarrow[n \rightarrow \infty]{a.s.} \sqrt{\pi}.$$

(ii) *There exists a random process  $(\mathcal{M}_\infty(x), x \in \mathbb{S}_1)$ , which is Hölder continuous with exponent  $\beta^* - \varepsilon$ , for every  $\varepsilon > 0$ , such that, for every  $x \in \mathbb{S}_1$ ,*

$$n^{-\beta^*/2} H_n(1, x) \xrightarrow[n \rightarrow \infty]{(\mathbb{P})} \mathcal{M}_\infty(x),$$

where  $\xrightarrow{(\mathbb{P})}$  denotes convergence in probability.

Part (i) of the theorem is a rather simple consequence of the results in [36, 37], but part (ii) is more delicate and requires different tools. Here we prove (more general versions of) the convergences in (i) and (ii) by using fragmentation theory. To this end, we consider continuous-time models where non-crossing chords are thrown at random in the unit disk according to the following device : At time  $t$ , the existing chords bound several subdomains of the disk, and a new chord is created in one of these subdomains at a rate which is a given power of the Lebesgue measure of the portion of the circle that is adjacent to this subdomain. It is not hard to see that the random closed subset of  $\overline{\mathbb{D}}$  obtained by taking the closure of all chords created in this process has the same distribution as  $L_\infty$ , and moreover the case when the power is the square is very closely related to the discrete-time model described above.

In this continuous-time model, the ranked sequence of the Lebesgue measures of the portions of  $\mathbb{S}_1$  corresponding to the subdomains bounded by the existing chords at time  $t$  forms a conservative fragmentation process, in the sense of [24]. A general version of the convergence (i) can then be obtained as a consequence of asymptotics for fragmentation processes. Similarly, if  $U$  is a random point uniformly distributed on  $\mathbb{S}_1$  and if we look only at subdomains that intersect the chord  $[1U]$ , we get another (dissipative) fragmentation process, and known asymptotics give the convergence in (ii), provided that  $x$  is replaced by the random point  $U$ . An extra absolute continuity

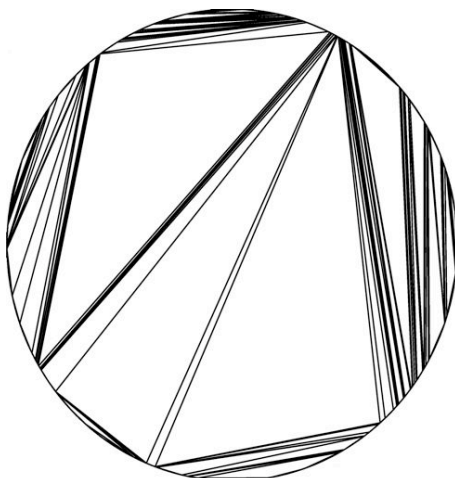

FIGURE 7.1 – The random set  $L_\infty$ .

argument is then needed to get the desired result for a deterministic point  $x$  : See Theorem 7.25 and its proof.

The most technical part of the proof of Theorem 7.1 is the derivation of the Hölder continuity properties of the limiting process  $(\mathcal{M}_\infty(x), x \in \mathbb{S}_1)$ . To this end, we need to obtain precise bounds for the moments of increments of this process. In order to derive these bounds, we rely on integral equations for the moments, which follow from the recursive construction.

Our second theorem shows that the random geodesic lamination  $L_\infty$  is coded by the process  $\mathcal{M}_\infty$ , in the sense of the following statement. For every  $x, y \in \mathbb{S}_1 \setminus \{1\}$ , we let  $\text{Arc}(x, y)$  denote the closed subarc of  $\mathbb{S}_1$  with endpoints  $x$  and  $y$  that does not contain the point 1. For every  $x \in \mathbb{S}_1 \setminus \{1\}$ , we let  $\text{Arc}(1, x) = \text{Arc}(x, 1)$  be the closed subarc of  $\mathbb{S}_1$  going from 1 to  $x$  in counterclockwise order, and we set  $\text{Arc}(1, 1) = \{1\}$  by convention.

**Theorem 7.2.** *The following properties hold almost surely. The random set  $L_\infty$  is the union of the chords  $[xy]$  for all  $x, y \in \mathbb{S}_1$  such that*

$$\mathcal{M}_\infty(x) = \mathcal{M}_\infty(y) = \min_{z \in \text{Arc}(x, y)} \mathcal{M}_\infty(z). \tag{7.1}$$

*Moreover,  $L_\infty$  is maximal for the inclusion relation among geodesic laminations.*

It is relatively easy to see that property (7.1) holds for any chord  $[xy]$  that arises in our construction of  $L_\infty$ . The difficult part of the proof of the theorem is to show the converse, namely that any chord  $[xy]$  such that (7.1) holds will be contained in  $L_\infty$ . This fact is indeed closely related to the maximality property of  $L_\infty$ .

The coding of geodesic laminations by continuous functions is discussed in [102], and is closely related to the coding of  $\mathbb{R}$ -trees by continuous functions (see e.g. [61]). A particular instance of this coding had been discussed earlier by Aldous [6], who considered the case when the coding function is the normalized Brownian excursion. In

that case, the associated  $\mathbb{R}$ -tree is Aldous’ CRT. Moreover, the Hausdorff dimension of the corresponding lamination is  $3/2$ . This may be compared to the following statement, where  $\dim(A)$  stands for the Hausdorff dimension of a subset  $A$  of the plane.

**Theorem 7.3.** *We have almost surely*

$$\dim(L_\infty) = \beta^* + 1 = \frac{\sqrt{17} - 1}{2}.$$

The lower bound  $\dim(L_\infty) \geq \beta^* + 1$  is a relatively easy consequence of the fact that  $L_\infty$  is coded by the function  $\mathcal{M}_\infty$  (Theorem 7.2) and of the Hölder continuity properties of this function (Theorem 7.1). In order to get the corresponding upper bound, we use explicit coverings of the set  $L_\infty$  that follow from our recursive construction. To evaluate the sum of the diameters of balls in these coverings raised to a suitable power, we again use certain asymptotics from fragmentation theory.

The random set  $L_\infty$  also occurs as the limit in distribution of certain random recursive triangulations of the  $n$ -gon. For every  $n \geq 3$ , we consider the  $n$ -gon whose vertices are the  $n$ -th roots of unity

$$x_k^n = \exp(2i\pi \frac{k}{n}), \quad k = 1, 2, \dots, n.$$

A chord of  $\mathbb{S}_1$  is called a diagonal of the  $n$ -gon if its vertices belong to the set  $\{x_k^n : 1 \leq k \leq n\}$  and if it is not an edge of the  $n$ -gon. A triangulation of the  $n$ -gon is the union of  $n - 3$  non-crossing diagonals of the  $n$ -gon (then the connected components of the complement of this union in the  $n$ -gon are indeed triangles). The set  $\mathcal{T}_n$  of all triangulations of the  $n$ -gon is in one-to-one correspondence with the set of all planar binary trees with  $n - 1$  leaves (see e.g. Aldous [6]).

For every fixed integer  $n \geq 4$ , we construct a random element of  $\mathcal{T}_n$  as follows. Denote by  $\mathcal{D}_n$  the set of all diagonals of the  $n$ -gon. Let  $c_1$  be chosen uniformly at random in  $\mathcal{D}_n$ . Then, conditionally given  $c_1$ , let  $c_2$  be a chord chosen uniformly at random in the set of all chords in  $\mathcal{D}_n$  that do not cross  $c_1$ . We continue by induction and construct a finite sequence of chords  $c_1, c_2, \dots, c_{n-3}$  : For every  $1 < k \leq n - 3$ ,  $c_k$  is chosen uniformly at random in the set of all chords in  $\mathcal{D}_n$  that do not cross  $c_1, c_2, \dots, c_{k-1}$ . Finally we let  $\Lambda_n$  be the union of the chords  $c_1, c_2, \dots, c_{n-3}$ .

Let us also introduce a slightly different model, which is closely related to [52]. Let  $\sigma$  be a uniformly distributed random permutation of  $\{1, 2, \dots, n\}$ . With  $\sigma$ , we associate a collection of diagonals of the  $n$ -gon, which is constructed recursively as follows. For every integer  $0 \leq k \leq n$  we define a set  $M_k$  of disjoint diagonals of the  $n$ -gon, and a set  $F_k$  of “free” vertices. We start with  $M_0 = F_0 = \emptyset$ . Then, at step  $k \in \{1, \dots, n\}$ , either there is a (necessarily unique) free vertex  $x \in F_{k-1}$  such that  $[xx_{\sigma(k)}^n]$  is a diagonal of the  $n$ -gon that does not intersect the chords in  $M_{k-1}$ , and we set  $M_k = M_{k-1} \cup \{[xx_{\sigma(k)}^n]\}$  and  $F_k = F_{k-1} \setminus \{x\}$ ; or there is no such vertex and we set  $M_k = M_{k-1}$  and  $F_k = F_{k-1} \cup \{x_{\sigma(k)}^n\}$ . We let  $\tilde{\Lambda}_n$  be the union of the chords in  $M_n$  (note that  $\tilde{\Lambda}_n$  is *not* a triangulation of the  $n$ -gon).

**Theorem 7.4.** *We have*

$$\Lambda_n \xrightarrow[n \rightarrow \infty]{(d)} L_\infty,$$

and

$$\tilde{\Lambda}_n \xrightarrow[n \rightarrow \infty]{(d)} L_\infty.$$

*In both cases, the convergence holds in distribution in the sense of the Hausdorff distance between compact subsets of  $\overline{\mathbb{D}}$ .*

Theorem 7.4 should be compared with the results of Aldous [6] (see also [5]). Aldous considers a triangulation of the  $n$ -gon that is uniformly distributed over  $\mathcal{T}_n$ , and then proves that this random triangulation converges in distribution as  $n \rightarrow \infty$  towards the geodesic lamination coded by the normalized Brownian excursion (see Theorem 7.10 below for a more precise statement). Our random recursive constructions give rise to a limiting geodesic lamination which is “bigger” than the one that appears in Aldous’s work, in the sense of Hausdorff dimension.

Triangulations of convex polygons are also interesting from the geometric and combinatorial point of view : see e.g. [132]. In [55], Devroye, Flajolet, Hurtado, Noy and Steiger studied some features of triangulations sampled uniformly from  $\mathcal{T}_n$ . Their proofs are based on combinatorial and enumeration techniques. Recursive triangulations of the type studied in the present work have been used in physics as greedy algorithms for computing folding of RNA structure (see [120]). In these models, the polymer is represented by a discrete cycle and diagonals correspond to liaisons of RNA bases. See [120], [52] and [51] for certain results related to our work, and in particular to the asymptotics of Theorem 7.1.

As a final remark, this work deals with “Euclidean” geodesic laminations consisting of unions of chords. As in [102], we may consider instead the hyperbolic geodesic laminations obtained by replacing each chord by the hyperbolic line with the same endpoints in the hyperbolic disk. It is immediate to verify that our main results remain valid after this replacement.

The paper is organized as follows. Section 2 recalls basic facts about geodesic laminations, and introduces the random processes  $(S_\alpha(t))_{t \geq 0}$  describing random recursive laminations, which are of interest in this work. Section 3 studies the connections between these random processes and fragmentation theory, and derives general forms of the asymptotics of Theorem 7.1. Section 4 is devoted to the continuity properties of the process  $\mathcal{M}_\infty$ . Theorem 7.2 characterizing  $L_\infty$  as the lamination coded by  $\mathcal{M}_\infty$  is proved in Section 5. The Hausdorff dimension of  $L_\infty$  is computed in Section 6, and Section 7 discusses the discrete models of Theorem 7.4. Finally, Section 8 gives some extensions and comments.

## 7.2 Random geodesic laminations

### 7.2.1 Laminations

Let us briefly recall the notation which was already introduced in Section 1. The open unit disk of the complex plane  $\mathbb{C}$  is denoted by  $\mathbb{D} = \{z \in \mathbb{C} : |z| < 1\}$ , and  $\mathbb{S}_1$  is

the unit circle. As usual, the closed unit disk is denoted by  $\overline{\mathbb{D}}$ . If  $x, y$  are two distinct points of  $\mathbb{S}_1$ , the *chord of feet  $x$  and  $y$*  is the closed line segment  $[xy] \subset \overline{\mathbb{D}}$ . We also use the notation  $]xy[$  for the open line segment with endpoints  $x$  and  $y$ . By convention,  $[xx]$  is equal to the singleton  $\{x\}$ , and is viewed as a degenerate chord, with  $]xx[ = \emptyset$ .

We say that two chords  $[xy]$  and  $[x'y']$  do not cross if  $]xy[\cap]x'y'[ = \emptyset$ .

**Definition 7.5.** *A geodesic lamination  $L$  of  $\overline{\mathbb{D}}$  is a closed subset  $L$  of  $\overline{\mathbb{D}}$  which can be written as the union of a collection of non-crossing chords. The lamination  $L$  is maximal if it is maximal for the inclusion relation among geodesic laminations of  $\overline{\mathbb{D}}$ .*

For simplicity, we will often say lamination instead of geodesic lamination of  $\overline{\mathbb{D}}$ . In the context of hyperbolic geometry [30], geodesic laminations of the disk are defined as closed subsets of the open (hyperbolic) disk. Here we prefer to view them as compact subsets of the closed disk, mainly because we want to discuss convergence of laminations in the sense of the Hausdorff distance. Notice that a maximal lamination necessarily contains the unit circle  $\mathbb{S}_1$ .

As the next lemma shows, the concept of a maximal lamination is a continuous analogue of a discrete triangulation.

**Lemma 7.6.** *Let  $L$  be a geodesic lamination of  $\overline{\mathbb{D}}$ . Then  $L$  is maximal if and only if the connected components of  $\overline{\mathbb{D}} \setminus L$  are open triangles whose vertices belong to  $\mathbb{S}_1$ .*

We leave the easy proof to the reader.

### 7.2.2 Figelas and associated trees

The simplest examples of laminations are finite unions of non-crossing chords. Define a *figela*  $S$  (from **f**inite **g**eodesic **l**amination) as a finite set of (unordered) pairs of distinct points of  $\mathbb{S}_1$  :

$$S = \{\{x_1, y_1\}, \dots, \{x_n, y_n\}\},$$

such that the union of the  $n$  chords  $\{[x_i y_i]\}_{1 \leq i \leq n}$  forms a lamination, which is then denoted by  $L_S$ . If  $\{x, y\} \in S$ , we will say that  $[xy]$  is a chord of the figela  $S$ . We denote the set  $\bigcup_{i=1}^n \{x_i, y_i\}$  of all feet of the chords of  $S$  by  $\text{Feet}(S)$ .

Let  $u, v \in \mathbb{S}_1 \setminus \text{Feet}(S)$ . The *height* between  $u$  and  $v$  in  $S$  is the number of chords of  $S$  crossed by the chord  $[uv]$  :

$$H_S(u, v) = \#\{1 \leq i \leq n : [x_i y_i] \cap [uv] \neq \emptyset\}.$$

The next proposition follows from simple geometric considerations.

**Proposition 7.7** (Triangle inequality). *Let  $S$  be a figela. For every  $x, y, z \in \mathbb{S}_1 \setminus \text{Feet}(S)$  we have*

$$H_S(x, z) \leq H_S(x, y) + H_S(y, z). \tag{7.2}$$

Let  $S = \{\{x_1, y_1\}, \dots, \{x_n, y_n\}\}$  be a figela. We define an equivalence relation on  $\mathbb{S}_1 \setminus \text{Feet}(S)$  by setting, for every  $u, v \in \mathbb{S}_1 \setminus \text{Feet}(S)$ ,

$$u \simeq v \text{ if and only if } H_S(u, v) = 0.$$

In other words, two points of  $\mathbb{S}_1 \setminus \text{Feet}(S)$  are equivalent if and only if they belong to the same connected component of  $\overline{\mathbb{D}} \setminus \cup_{i=1}^n [x_i y_i]$ . Then  $H_S$  induces a distance on the quotient set  $\mathcal{T}_S := (\mathbb{S}_1 \setminus \text{Feet}(S)) / \simeq$ . The finite metric space  $\mathcal{T}_S$  can be viewed as a graph by declaring that there is an edge between  $a$  and  $b$  if and only if  $H_S(a, b) = 1$ . This graph is indeed a tree, and  $H_S(\cdot, \cdot)$  coincides with the usual graph distance. The tree  $\mathcal{T}_S$  can be rooted at the equivalence class of 1 (we assume that 1 is not a foot of  $S$ , which will always be the case in our examples). As a result of this discussion, we can associate a plane (rooted ordered) tree  $\mathcal{T}_S$  to  $S$ . See Fig. 2 for an example from which the definition of the tree  $\mathcal{T}_S$  should be clear.

The  $n + 1$  connected components of  $\overline{\mathbb{D}} \setminus \cup_{i=1}^n [x_i y_i]$  are called the *fragments* of the figela  $S$ . With each fragment  $R$ , we associate its *mass*

$$m(R) = \lambda(R \cap \mathbb{S}_1),$$

where  $\lambda$  denotes the uniform probability measure on  $\mathbb{S}_1$ .

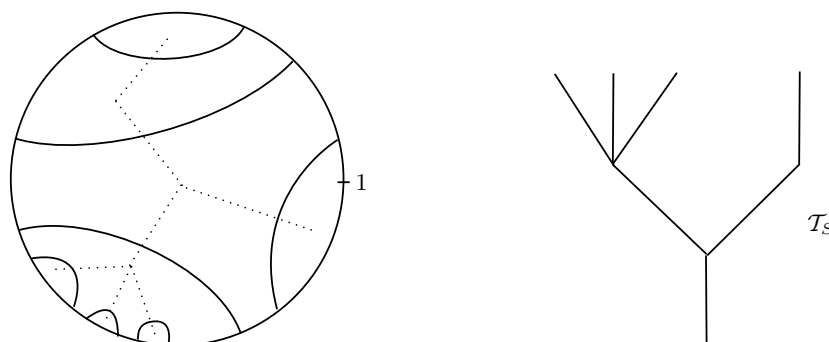

FIGURE 7.2 – A figela and its associated plane tree (in dotted lines on the left side). We drew chords as curved lines for better visibility. In this example,  $S$  has 7 chords and 8 fragments. Notice that each fragment of  $S$  corresponds to a vertex of the tree  $\mathcal{T}_S$ .

### 7.2.3 Coding by continuous functions

Let  $g : [0, 1] \rightarrow \mathbb{R}_+$  be a continuous function such that  $g(0) = g(1) = 0$ . We define a pseudo-distance on  $[0, 1]$  by

$$d_g(s, t) = g(s) + g(t) - 2 \min_{r \in [s \wedge t, s \vee t]} g(r),$$

for every  $s, t \in [0, 1]$ . The associated equivalence relation on  $[0, 1]$  is defined by setting  $s \stackrel{g}{\sim} t$  if and only if  $d_g(s, t) = 0$ , or equivalently  $g(s) = g(t) = \min_{r \in [s \wedge t, s \vee t]} g(r)$ .

**Proposition 7.8** ([61]). *The quotient set  $T_g := [0, 1] / \stackrel{g}{\sim}$  endowed with the distance  $d_g$  is an  $\mathbb{R}$ -tree called the tree coded by the function  $g$ .*

We refer to [63] for an extensive discussion of  $\mathbb{R}$ -trees in probability theory.

In order to introduce the lamination coded by  $g$ , we need some additional notation. For  $s \in [0, 1]$ , we let  $\text{cl}_g(s)$  be the equivalence class of  $s$  with respect to the equivalence relation  $\overset{g}{\sim}$ . Then, for  $s, t \in [0, 1]$ , we set  $s \overset{g}{\approx} t$  if at least one of the following two conditions holds :

- $s \overset{g}{\approx} t$  and  $g(r) > g(s)$  for every  $r \in ]s \wedge t, s \vee t[$ .
- $s \overset{g}{\approx} t$  and  $s \wedge t = \min \text{cl}_g(s), s \vee t = \max \text{cl}_g(s)$ .

In particular,  $s \overset{g}{\approx} s$ , and  $s \overset{g}{\approx} t$  holds if and only if  $t \overset{g}{\approx} s$ . Note however that  $\overset{g}{\approx}$  is in general not an equivalence relation. It is an elementary exercise to check that the graph  $\{(s, t) : s \overset{g}{\approx} t\}$  is a closed subset of  $[0, 1]^2$ .

**Proposition 7.9.** *The set*

$$L_g := \bigcup_{s \overset{g}{\approx} t} \left[ e^{2i\pi s} e^{2i\pi t} \right], \tag{7.3}$$

*is a geodesic lamination of  $\overline{\mathbb{D}}$  called the lamination coded by the function  $g$ . Furthermore,  $L_g$  is maximal if and only if, for every open subinterval  $]s, t[$  of  $[0, 1]$ , the infimum of  $g$  over  $]s, t[$  is attained at at most one point of  $]s, t[$ .*

We leave the proof to the reader. See [102, Proposition 2.1] for a closely related statement. This proposition is stated under the assumption that the local minima of  $g$  are distinct, which is slightly stronger than the condition in the second assertion of Proposition 7.9. Note that the latter condition is equivalent to saying that the relations  $\overset{g}{\sim}$  and  $\overset{g}{\approx}$  coincide, or that  $\overset{g}{\approx}$  is an equivalence relation.

We end this section by reformulating in this formalism a theorem of Aldous which was already mentioned in the introduction. Recall our notation  $\mathcal{T}_n$  for the set of all triangulations of the  $n$ -gon. An element of  $\mathcal{T}_n$  is just a geodesic lamination consisting of  $n - 3$  chords whose feet belong to the set of  $n$ -th roots of unity.

**Theorem 7.10** ([6],[5]). *Let  $(\mathbf{e}_t)_{0 \leq t \leq 1}$  be a normalized Brownian excursion, and let  $\Delta_n$  be uniformly distributed over  $\mathcal{T}_n$ . Then we have*

$$\Delta_n \xrightarrow[n \rightarrow \infty]{(d)} L_{\mathbf{e}},$$

*in the sense of the Hausdorff distance between compact subsets of  $\overline{\mathbb{D}}$ . Moreover the Hausdorff dimension of  $L_{\mathbf{e}}$  is almost surely equal to  $3/2$ .*

A detailed argument for the calculation of the Hausdorff dimension of  $L_{\mathbf{e}}$  is given in [102] (the proof in [6] is only sketched).

### 7.2.4 Random recursive laminations

Let  $\alpha \geq 0$  be a positive real number. We define a Markov jump process  $(S_\alpha(t), t \geq 0)$  taking values in the space of all figelas, and increasing in the sense of the inclusion order.

Let us describe the construction of this process. We introduce a sequence of random times  $0 = \tau_0 < \tau_1 < \tau_2 < \dots$  such that  $S_\alpha(t)$  is constant over each interval  $[\tau_n, \tau_{n+1}[$ , and  $S_\alpha(\tau_n)$  has exactly  $n$  chords (in particular  $S_\alpha(0)$  is the empty figela). We define the pairs  $(\tau_n, S_\alpha(\tau_n))$  for every  $n \geq 1$  recursively as follows. In order to describe the joint



distribution of  $(\tau_{n+1}, S_\alpha(\tau_{n+1}))$  given the  $\sigma$ -field  $\mathcal{F}_n = \sigma(\tau_0, \dots, \tau_n, S_\alpha(\tau_1), \dots, S_\alpha(\tau_n))$ , we write  $R_1^n, \dots, R_{n+1}^n$  for the  $n+1$  fragments of the figela  $S_\alpha(\tau_n)$ , and we let  $e_1, \dots, e_{n+1}$  be  $n+1$  independent exponential variables with parameter 1 that are also independent of  $\mathcal{F}_n$ . Then, for  $1 \leq j \leq n+1$ , we set  $\mathcal{E}_j = m(R_j^n)^{-\alpha} e_j$  and we let  $j_0$  be the a.s. unique index such that  $\mathcal{E}_{j_0} = \min\{\mathcal{E}_j : 1 \leq j \leq n+1\}$ . Conditionally given  $\mathcal{F}_n$  and  $(e_1, \dots, e_n)$ , we sample two independent random variables  $X_{n+1}$ , and  $Y_{n+1}$  uniformly distributed over  $R_{j_0} \cap \mathbb{S}_1$ . Then conditionally on  $\mathcal{F}_n$ , the pair  $(\tau_{n+1}, S_\alpha(\tau_{n+1}))$  has the same distribution as  $(\tau_n + \mathcal{E}_{j_0}, S_\alpha(\tau_n) \cup \{\{X_{n+1}, Y_{n+1}\}\})$ .

Note that  $\tau_n \rightarrow \infty$  a.s. when  $n \rightarrow \infty$ . Indeed, it is enough to see this when  $\alpha = 0$ , and then  $\tau_{n+1} - \tau_n$  is exponential with parameter  $n+1$ . Therefore the processes  $S_\alpha(t)$  are well-defined for every  $t \geq 0$ .

If  $R$  is a fragment of  $S_\alpha(t)$ , then independently of the past up to time  $t$ , a new chord is added in  $R$  at rate  $m(R)^\alpha$ . The preceding construction can thus be interpreted informally : The first chord is thrown in  $\overline{\mathbb{D}}$  uniformly at random (the two endpoints of the chord are chosen independently and uniformly over  $\mathbb{S}_1$ ) at an exponential time with parameter 1, and divides it into two fragments  $R_0$  and  $R_1$ . These two fragments can be identified with two disks if we contract the first chord (the boundaries of these disks are then identified respectively with  $R_i \cap \mathbb{S}_1$  for  $i \in \{0, 1\}$ ). Then the process goes on independently inside each of these disks provided that we rescale time by the mass of the corresponding fragment to the power  $\alpha$ .

The process  $(S_\alpha(t), t \geq 0)$  will be called the figela process with autosimilarity parameter  $\alpha$ .

**Remark 7.11.** Let  $\{(t_i, (x_i, y_i))\}_{i \in \mathbb{N}}$  be the atoms of a Poisson point measure on  $\mathbb{R}_+ \times \mathbb{S}_1 \times \mathbb{S}_1$  with intensity  $dt \otimes \lambda \otimes \lambda$ , where we recall that  $\lambda$  is the uniform probability measure on  $\mathbb{S}_1$ . We suppose that the atoms of the Poisson measure are ordered so that  $0 < t_1 < t_2 < \dots$ , and we also set  $t_0 = 0$ . We construct a figela-valued jump process  $(\mathcal{S}(t), t \geq 0)$  using the following device. We start from  $\mathcal{S}(0) = \emptyset$ , and the process may jump only at times  $t_1, t_2, \dots$ . For every  $i \geq 1$ , we take  $\mathcal{S}(t_i) = \mathcal{S}(t_{i-1}) \cup \{(x_i, y_i)\}$  if the chord of feet  $x_i$  and  $y_i$  does not cross any chord of  $\mathcal{S}(t_{i-1})$ , and otherwise we take  $\mathcal{S}(t_i) = \mathcal{S}(t_{i-1})$ . It follows from properties of Poisson measures that this process has the same law as our process  $(S_2(t), t \geq 0)$ . Moreover, the discrete-time process  $(L_{\mathcal{S}(t_n)}, n \geq 0)$  has the same distribution as the process  $(L_n, n \geq 0)$  discussed in Section 1. Thanks to this observation, and to the fact that  $n^{-1}t_n$  tends to 1 a.s., forthcoming results about asymptotics of the processes  $(S_\alpha(t), t \geq 0)$  will carry over to the process  $(L_n, n \geq 0)$ .

**Remark 7.12** (Rotational invariance). Let  $(S_\alpha(t))_{t \geq 0}$  be a figela process with parameter  $\alpha$ . For every  $z \in \mathbb{S}_1$ , set

$$S_\alpha^z(t) = \{\{zx, zy\} : \{x, y\} \in S_\alpha(t)\}.$$

Then  $(S_\alpha^z(t), t \geq 0)$  has the same distribution as  $(S_\alpha(t), t \geq 0)$ .

It will be important to construct simultaneously the processes  $(S_\alpha(t))_{t \geq 0}$  for all values of  $\alpha \geq 0$ , in the following way. We set

$$\mathbb{T} = \bigcup_{n \geq 0} \{0, 1\}^n \tag{7.4}$$

where  $\{0, 1\}^0 = \{\emptyset\}$ . We consider a collection  $(\epsilon_u)_{u \in \mathbb{T}}$  of independent exponential variables with parameter 1. The first chord then appears at time  $\epsilon_\emptyset$ . If  $R_0$  and  $R_1$  are the two fragments created at this moment, a new chord will appear in  $R_0$ , resp. in  $R_1$ , at time  $\epsilon_\emptyset + m(R_0)^{-\alpha} \epsilon_0$ , resp. at time  $\epsilon_\emptyset + m(R_1)^{-\alpha} \epsilon_1$ . We continue the construction by induction. If we use the same random choices of the new chords independently of  $\alpha$  (so that the same fragments will also appear), we get a coupling of the processes  $(S_\alpha(t))_{t \geq 0}$  for all  $\alpha \geq 0$ .

This coupling is such that a.s. for every  $t \geq 0$  and for every  $\alpha' \geq \alpha \geq 0$ , there exists a finite random time  $T_{t, \alpha, \alpha'} \geq t$  such that

$$S_{\alpha'}(t) \subset S_\alpha(t) \subset S_{\alpha'}(T_{t, \alpha, \alpha'}).$$

In the remaining part of this work, we will always assume that the processes  $(S_\alpha(t))_{t \geq 0}$  are coupled in this way. Hence, the increasing limit  $S(\infty) = \lim \uparrow S_\alpha(t)$  as  $t \uparrow \infty$  does not depend on  $\alpha$ , and the same holds for the random closed subset of  $\overline{\mathbb{D}}$  defined by

$$L_\infty = \overline{\bigcup_{\{x, y\} \in S(\infty)} [xy]}.$$

By the discussion in Remark 7.11, this is consistent with the definition of  $L_\infty$  in Section 1. We note that  $L_\infty$  is a (random) geodesic lamination. To see this, write  $S^*(\infty)$  for the closure in  $\mathbb{S}_1 \times \mathbb{S}_1$  of the set of all (ordered) pairs  $(x, y)$  such that  $\{x, y\}$  belongs to  $S(\infty)$ . Then a simple argument shows that

$$L_\infty = \bigcup_{(x, y) \in S^*(\infty)} [xy],$$

and moreover if  $(x, y)$  and  $(x', y')$  belong to  $S^*(\infty)$  the chords  $[xy]$  and  $[x'y']$  either coincide or do not cross.

## 7.3 Random fragmentations

### 7.3.1 Fragmentation theory

In this subsection, we briefly recall the results from fragmentation theory that we will use, in the particular case of binary fragmentation which is relevant to our applications. For a more detailed presentation, we refer to Bertoin’s book [24].

We consider a probability measure  $\nu$  on  $[0, 1]^2$ . We assume that  $\nu$  is supported on the set  $\{(s_1, s_2) : 1 > s_1 \geq s_2 \geq 0, s_1 + s_2 \leq 1\}$ , and satisfies the following additional properties :

- (H) (i)  $\nu(\{s_2 > 0\}) > 0$ ,
- (ii)  $\nu(\{s_1 = 0\}) = 0$ .

Such a measure is a special case of a *dislocation measure*. Furthermore, if  $\nu(\{s_1 + s_2 = 1\}) = 1$ , then  $\nu$  is said to be *conservative*. It is called *non-conservative* or *dissipative* otherwise.

Let  $\mathcal{S}^\downarrow$  be the set of all real sequences  $(s_1, s_2, \dots)$  such that  $1 \geq s_1 \geq s_2 \geq \dots \geq 0$  and  $\sum_{i=1}^\infty s_i \leq 1$ . A fragmentation process with autosimilar parameter  $\alpha \geq 0$ , and

dislocation measure  $\nu$  is a Markov process  $(X^{(\alpha)}(t), t \geq 0)$  with values in  $\mathcal{S}^\downarrow$  whose evolution can be described informally as follows (see [24] for a more rigorous presentation). Let  $X^{(\alpha)}(t) = (s_1(t), s_2(t), \dots)$  be the state of the process at time  $t \geq 0$ . For each  $i \geq 1$ ,  $s_i(t)$  represents the mass of the  $i$ -th particle at time  $t$  (particles are ranked according to decreasing masses). Conditionally on the past up to time  $t$ , the  $i$ -th particle lives after time  $t$  during an exponential time of parameter  $(s_i(t))^\alpha$ , then dies and gives birth to two particles of respective masses  $R_1 s_i(t)$  and  $R_2 s_i(t)$ , where the pair  $(R_1, R_2)$  is sampled from  $\nu$  independently of the past.

**Remark 7.13.** We will not be interested in the case  $\alpha < 0$ , which is not relevant for our applications.

We can construct simultaneously the processes  $(X^{(\alpha)}(t))_{t \geq 0}$  starting from  $X^{(\alpha)}(0) = (1, 0, \dots)$ , for all values of  $\alpha \geq 0$  in the following way. Consider first the process  $X^{(0)}$  corresponding to  $\alpha = 0$ . We represent the genealogy of this process by the infinite binary tree  $\mathbb{T}$  defined in (7.4). Each  $u \in \mathbb{T}$  thus corresponds to a “particle” in the fragmentation process. We denote the mass of  $u$  by  $\xi_u$  and the lifetime of  $u$  by  $\zeta_u^{(0)}$ . Since we are considering the case  $\alpha = 0$ , the random variables  $(\zeta_u^{(0)})_{u \in \mathbb{T}}$  are independent and exponentially distributed with parameter 1. If we now want to construct  $(X^{(\alpha)}(t))_{t \geq 0}$  for a given value of  $\alpha$ , we keep the same values  $\xi_u$  for the masses of particles, but we replace the lifetimes by  $\zeta_u^{(\alpha)} = (\xi_u)^{-\alpha} \zeta_u^{(0)}$ , for every  $u \in \mathbb{T}$ . See [24, Corollary 1.2] for more details.

In the remaining part of this subsection, we assume that the processes  $(X^{(\alpha)}(t))_{t \geq 0}$  starting from  $X^{(\alpha)}(0) = (1, 0, \dots)$  are defined for every  $\alpha \geq 0$  and coupled as explained above.

We set for every real  $p \geq 0$ ,

$$\kappa_\nu(p) = \int_{[0,1]^2} (1 - (s_1^p + s_2^p)) \nu(ds_1, ds_2),$$

where by convention  $0^0 = 0$ . Then  $\kappa_\nu$  is a continuous increasing function. Under Assumption (H),  $\kappa_\nu(0) < 0$  and  $\kappa_\nu(+\infty) = 1$ , and therefore there exists a unique  $p^* > 0$ , called the Malthusian exponent of  $\nu$ , such that

$$\kappa_\nu(p^*) = 0.$$

The Malthusian exponent allows us to introduce the so-called Malthusian martingale, which is discussed in part (i) of the next theorem.

**Theorem 7.14.** Write  $X^{(\alpha)}(t) = (s_1^{(\alpha)}(t), s_2^{(\alpha)}(t), \dots)$  for every  $t \geq 0$  and  $\alpha \geq 0$ . Then :

(i) For every  $\alpha \geq 0$ , the process

$$\mathcal{M}^{(\alpha)}(t) := \sum_{i=1}^{\infty} (s_i^{(\alpha)}(t))^{p^*}, \quad t \geq 0,$$

is a uniformly integrable martingale and converges almost surely to a limiting random variable  $\mathcal{M}_\infty$ , which does not depend on  $\alpha$ . Moreover  $\mathcal{M}_\infty > 0$  a.s., and

$\mathcal{M}_\infty$  satisfies the following identity in distribution

$$\mathcal{M}_\infty \stackrel{(d)}{=} \Sigma_1^{p^*} \mathcal{M}'_\infty + \Sigma_2^{p^*} \mathcal{M}''_\infty \tag{7.5}$$

where  $(\Sigma_1, \Sigma_2)$  is distributed according to  $\nu$ , and  $\mathcal{M}'_\infty$  and  $\mathcal{M}''_\infty$  are independent copies of  $\mathcal{M}_\infty$ , which are also independent of the pair  $(\Sigma_1, \Sigma_2)$ . This identity in distribution characterizes the distribution of  $\mathcal{M}_\infty$  among all probability measures on  $\mathbb{R}_+$  with mean 1. Furthermore, we have  $\mathbb{E}[\mathcal{M}_\infty^q] < \infty$  for every real  $q \geq 1$ .

(ii) For every real  $p \geq 0$ , the process

$$e^{t\kappa_\nu(p)} \sum_{i=1}^{\infty} (s_i^{(0)}(t))^p, \quad t \geq 0,$$

is a martingale and converges a.s. to a positive limiting random variable.

(iii) Let  $\alpha > 0$ . Assume that  $\int s_2^{-\alpha} \nu(ds_1, ds_2) < \infty$  for some  $\alpha > 0$ . Then for every  $p \geq 0$ ,

$$t^{\frac{p-p^*}{\alpha}} \sum_{i=1}^{\infty} (s_i^{(\alpha)}(t))^p \xrightarrow[t \rightarrow \infty]{\mathbb{L}^2} K_\nu(\alpha, p) \mathcal{M}_\infty,$$

where  $K_\nu(\alpha, p)$  is a positive constant depending on  $\alpha$ ,  $p$  and  $\nu$ , and the limiting variable  $\mathcal{M}_\infty$  is the same as in (i).

*Démonstration.* The fact that  $\mathcal{M}^{(\alpha)}(t)$  is a uniformly integrable martingale follows from [24, Proposition 1.5]. This statement also shows that the almost sure limit  $\mathcal{M}_\infty$  of this martingale coincides with the limit of the so-called intrinsic martingale, and therefore does not depend on  $\alpha$ . By uniform integrability, we have  $\mathbb{E}[\mathcal{M}_\infty] = \mathbb{E}[\mathcal{M}^{(\alpha)}(0)] = 1$ . The property  $\mathcal{M}_\infty > 0$  a.s. follows from [24, Theorem 1.1]. The identity in distribution (7.5) is a special case of (1.20) in [24]. The fact that the distribution of  $\mathcal{M}_\infty$  is characterized by this identity (and the property  $\mathbb{E}[\mathcal{M}_\infty] = 1$ ) follows from Theorem 1.1 in [104]. The property  $\mathbb{E}[\mathcal{M}_\infty^q] < \infty$  for every  $q \geq 1$  is a consequence of Theorem 5.1 in the same article.

Then, assertion (ii) follows from Corollary 1.3 and Theorem 1.4 in [24]. Finally, assertion (iii) can be found in [25, Corollary 7] under more general assumptions.  $\square$

**Remark 7.15.** In the conservative case, we immediately see that  $p^* = 1$  and  $\mathcal{M}_\infty = 1$ .

### 7.3.2 The number of chords in the figela process

Let  $\nu_C$  be the probability measure on  $[0, 1]^2$  defined by

$$\int \nu_C(ds_1, ds_2) F(s_1, s_2) = 2 \int_{1/2}^1 du F(u, 1-u),$$

for every nonnegative Borel function  $F$ . Clearly  $\nu_C$  satisfies the assumptions of the previous subsection.

**Proposition 7.16.** Fix  $\alpha \geq 0$ . We denote by  $R_1^\alpha(t), R_2^\alpha(t), \dots$  the fragments of the figela  $S_\alpha(t)$ , ranked according to decreasing masses. Then the process

$$X_\alpha(t) = (m(R_1^\alpha(t)), m(R_2^\alpha(t)), \dots),$$

is a fragmentation process with parameters  $(\alpha, \nu_C)$ .

*Démonstration.* From the construction of the figela processes, we see that, when a chord appears in a fragment  $R$  of the figela, it divides this fragment into two new fragments of respective masses  $U m(R)$  and  $(1 - U) m(R)$  where  $U$  is uniformly distributed over  $[0, 1]$ . The ranked pair of these masses is thus distributed as  $(s_1 m(R), s_2 m(R))$  under  $\nu_C(ds_1, ds_2)$ . Furthermore a fragment  $R$  splits at rate  $m(R)^\alpha$ . The desired conclusion easily follows. We leave details to the reader.  $\square$

**Remark 7.17.** The coupling of  $(S_\alpha(t), t \geq 0)$  for all  $\alpha \geq 0$  yields a coupling of the associated fragmentation processes  $(X_\alpha(t), t \geq 0)$ . This is indeed the same coupling that was already discussed in the previous subsection.

By combining Proposition 7.16 with Theorem 7.14, we already get detailed information about the asymptotic number of chords in the figela processes  $(S_\alpha(t))_{t \geq 0}$ .

**Corollary 7.18.** We have the following convergences.

- (i) If  $\alpha = 0$ ,  $e^{-t} \#S_0(t) \xrightarrow[t \rightarrow \infty]{a.s.} \mathcal{E}$ , where  $\mathcal{E}$  is exponentially distributed with parameter 1.
- (ii) If  $\alpha > 0$ ,  $t^{-1/\alpha} \#S_\alpha(t) \xrightarrow[t \rightarrow \infty]{a.s.} \frac{\Gamma(1/\alpha)}{\Gamma(2/\alpha)}$ .

*Démonstration.* (i) The case  $p = 0$  in assertion (ii) of Theorem 7.14 gives the almost sure convergence of the martingale  $e^{-t} \#S_0(t)$ . In fact,  $(\#S_0(t))_{t \geq 0}$  is a Yule process of parameter 1, which allows us to identify the limit law, see [12, p127-130].

(ii) We first observe that  $\nu_C$  is conservative and thus  $\mathcal{M}_\infty = 1$  in the notation of Theorem 7.14. The  $\mathbb{L}^2$ -convergence of  $t^{-1/\alpha} \#(S_\alpha(t))$  towards a constant  $K_{\nu_C}(\alpha, 0)$  follows from Theorem 7.14 (iii) with  $p = 0$ . From [37, Corollary 7], there is even almost sure convergence and the constant  $K_{\nu_C}(\alpha, 0)$  is given by  $K_{\nu_C}(\alpha, 0) = \Gamma(1/\alpha)/\Gamma(2/\alpha)$ .  $\square$

A dissymmetry appears between the cases  $\alpha = 0$  and  $\alpha > 0$ . When  $\alpha = 0$ , the number of chords grows exponentially with a random multiplicative factor, but when  $\alpha > 0$  the number of chords only grows like a power of  $t$ , with a deterministic multiplicative factor.

### 7.3.3 Fragments separating 1 from a uniform point

Let  $V$  be uniformly distributed over  $\mathbb{S}_1$  and independent of  $(S_\alpha(t), t \geq 0, \alpha \geq 0)$ . Almost surely for every  $\alpha, t \geq 0$ , the points 1 and  $V$  do not belong to Feet( $S_\alpha(t)$ ). Our goal is to establish a connection between  $H_{S_\alpha(t)}(1, V)$  (the height between 1 and  $V$  in  $S_\alpha(t)$ ) and a certain fragmentation process.

To this end, we first discuss the behavior of the figela process after the appearance of the first chord. We briefly mentioned that the two fragments created by the first chord

of the figela process can be viewed as two new disks by contracting the chord and that, after the time of appearance of the first chord, the process will behave, independently in each of these two disks, as a rescaled copy of the original process. Let us explain this in a more formal way. We fix  $\alpha \geq 0$ .

Let  $[ab]$  be the first chord of the figela process  $(S_\alpha(t))_{t \geq 0}$ , which appears after an exponential time  $\tau$  with parameter 1. We may write  $a = e^{2i\pi U_1}$ ,  $b = e^{2i\pi U_2}$ , where the pair  $(U_1, U_2)$  has density  $2 \cdot \mathbf{1}_{\{0 < u_1 < u_2 < 1\}}$  with respect to Lebesgue measure on  $[0, 1]^2$ . Let

$$M = 1 - (U_2 - U_1),$$

be the mass of the fragment of  $S_\alpha(\tau)$  containing the point 1. Define two mappings  $\psi_{U_1, U_2} : [0, U_1] \cup [U_2, 1] \rightarrow [0, 1]$  and  $\phi_{U_1, U_2} : [U_1, U_2] \rightarrow [0, 1]$  by setting

$$\begin{aligned} \psi_{U_1, U_2}(r) &= \begin{cases} \frac{r}{M} & \text{if } 0 \leq r \leq U_1, \\ \frac{r - (U_2 - U_1)}{M} & \text{if } U_2 \leq r \leq 1. \end{cases} \\ \phi_{U_1, U_2}(r) &= \frac{r - U_1}{U_2 - U_1} \quad \text{if } U_1 \leq r \leq U_2. \end{aligned}$$

Also let  $\Psi_{a,b}$  and  $\Phi_{a,b}$  be the mappings corresponding to  $\psi_{U_1, U_2}$  and  $\phi_{U_1, U_2}$  when  $\mathbb{S}_1$  is identified to  $[0, 1[$  :

$$\begin{aligned} \Psi_{a,b}(\exp(2i\pi r)) &= \exp(2i\pi \psi_{U_1, U_2}(r)), & \text{if } r \in [0, U_1] \cup [U_2, 1], \\ \Phi_{a,b}(\exp(2i\pi r)) &= \exp(2i\pi \phi_{U_1, U_2}(r)), & \text{if } r \in [U_1, U_2]. \end{aligned}$$

The first chord  $[ab]$  creates two fragments. Let  $R'$  the fragment (of mass  $M$ ) containing 1 and let  $R''$  be the other fragment. For  $t \geq \tau$ , we let  $S_\alpha^{(R')}(t)$  (resp.  $S_\alpha^{(R'')}(t)$ ) be the subset of  $S_\alpha(t) \setminus \{a, b\}$  consisting of all pairs  $\{x, y\}$  such that the corresponding chord is contained in  $R'$  (resp. in  $R''$ ).

**Lemma 7.19.** *Let  $\alpha \geq 0$ . Conditionally on  $(\tau, U_1, U_2)$ , the pair of processes*

$$\left( \left( \Psi_{a,b} \left( S_\alpha^{(R')}(\tau + t) \right) \right)_{t \geq 0}, \left( \Phi_{a,b} \left( S_\alpha^{(R'')}(\tau + t) \right) \right)_{t \geq 0} \right)$$

*has the same distribution as*

$$\left( (S'_\alpha(M^\alpha t))_{t \geq 0}, (S''_\alpha((1 - M)^\alpha t))_{t \geq 0} \right)$$

*where  $S'_\alpha$  and  $S''_\alpha$  are two independent copies of the process  $S_\alpha$ .*

This follows readily from our recursive construction of the figela process.

**Definition 7.20.** *Let  $S$  be a figela, and  $x, y \in \mathbb{S}_1 \setminus \text{Feet}(S)$ . We call fragments separating  $x$  from  $y$  in  $S$ , the fragments of  $S$  that intersect the chord  $[xy]$ . These fragments are ranked according to decreasing masses and denoted by*

$$R_1^{(x,y)}(S), R_2^{(x,y)}(S), R_3^{(x,y)}(S), \dots$$

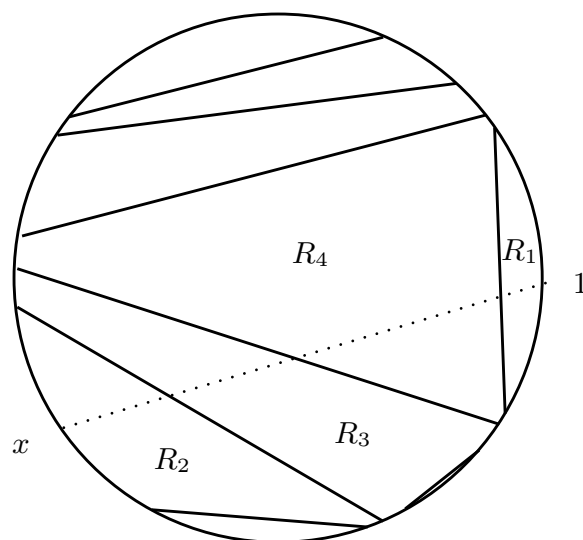

FIGURE 7.3 – A figela with 4 fragments  $R_1, R_2, R_3, R_4$  separating 1 from  $x$ .

See Fig.3 for an example.

In order to state the main result of this subsection, we need one more definition. We let  $\nu_D$  be the probability measure on  $[0, 1]^2$  defined by

$$\int_{[0,1]^2} \nu_D(ds_1, ds_2) F(s_1, s_2) = 2 \int_0^1 du u^2 F(u, 0) + 4 \int_{1/2}^1 du u(1-u) F(u, 1-u).$$

for every nonnegative Borel function  $F$ .

The measure  $\nu_D$  is interpreted as follows. Let  $U, X_1$  and  $X_2$  be independent and uniformly distributed over  $[0, 1]$ . The point  $U$  splits the interval  $[0, 1]$  in two parts,  $[0, U[$  and  $]U, 1]$ . We keep each of these parts if and only if it contains at least one of the two points  $X_1$  or  $X_2$ . Then  $\nu_D$  corresponds to the distribution of the masses of the remaining parts ranked in decreasing order.

**Proposition 7.21.** *Let  $V$  be a random variable uniformly distributed over  $\mathbb{S}_1$  and independent of  $(S_\alpha(t), t \geq 0, \alpha \geq 0)$ . The sequence of masses of the fragments separating 1 from  $V$  in  $S_\alpha(t)$ , namely*

$$\mathcal{X}_\alpha(t) = \left( m \left( R_1^{(1,V)}(S_\alpha(t)) \right), m \left( R_2^{(1,V)}(S_\alpha(t)) \right), \dots \right),$$

*is a fragmentation process with parameters  $(\alpha, \nu_D)$ .*

**Remark 7.22.** Similarly as in Remark 7.17, the coupling of the processes  $(S_\alpha(t), t \geq 0)$  for  $\alpha \geq 0$  induces the corresponding coupling of the processes  $(\mathcal{X}_\alpha(t), t \geq 0)$  for  $\alpha \geq 0$ .

*Démonstration.* We use the notation of the beginning of this subsection. Two cases may occur.

1. The point  $V$  belongs to the fragment  $R'$ . Note that, conditionally on the first chord  $[ab]$  and on  $\{V \in R'\}$ ,  $\Psi_{a,b}(V)$  is uniformly distributed over  $\mathbb{S}_1$ . Furthermore, the future evolution of the process  $\mathcal{X}_\alpha(t)$  after time  $\tau$  only depends on those chords that fall in the fragment  $R'$  (and not on chords that fall in  $R''$ ). More precisely, with the notation of Lemma 7.19, the masses of the fragments of  $S_\alpha(\tau + t)$  separating 1 from  $V$  will be the same, up to the multiplicative factor  $M$ , as the masses of the fragments of  $\Psi_{a,b}(S_\alpha^{(R')}(\tau + t))$  separating 1 from  $\Psi_{a,b}(V)$ . By Lemma 7.19, conditionally on the event  $\{V \in R'\}$  and on the pair  $(\tau, M)$ , the process  $(\mathcal{X}_\alpha(\tau + t))_{t \geq 0}$  has the same distribution as

$$(M \mathcal{X}_\alpha(M^\alpha t))_{t \geq 0},$$

where  $(\mathcal{X}_\alpha(t))_{t \geq 0}$  is a copy of  $(\mathcal{X}_\alpha(t))_{t \geq 0}$ , which is independent of the pair  $(\tau, M)$ .

2. The point  $V$  belongs to the fragment  $R''$  (see Fig. 4). For  $t \geq \tau$ , the fragments separating  $V$  from 1 in  $S_\alpha(t)$  will correspond either to fragments in the disk obtained from  $R'$  by contracting the first chord  $[ab]$ , provided these fragments separate 1 from  $\Psi_{a,b}(a)$ , or to fragments in the disk obtained from  $R''$  by contracting the first chord, provided these fragments separate  $\Phi_{a,b}(a) = 1$  from  $\Phi_{a,b}(V)$ . An easy calculation shows that, conditionally on  $\{V \in R''\}$  and on  $(\tau, M)$ , the points  $\Psi_{a,b}(a)$  and  $\Phi_{a,b}(V)$  are independent and uniformly distributed over  $\mathbb{S}_1$ . Using Lemma 7.19 once again, we get that the sequence of the masses of separating fragments contained in  $R'$  at time  $\tau + t$  has, as a process in the variable  $t$ , the same distribution as  $(M \mathcal{X}_\alpha(M^\alpha t))_{t \geq 0}$ , where  $\mathcal{X}_\alpha$  is an independent copy of  $\mathcal{X}_\alpha$ . A similar observation holds for the separating fragments in  $R''$ . Consequently, conditionally on the event  $\{V \in R''\}$  and on the pair  $(\tau, M)$ , the process  $(\mathcal{X}_\alpha(\tau + t))_{t \geq 0}$  has the same distribution as

$$\left( M \mathcal{X}_\alpha(M^\alpha t) \dot{\cup} (1 - M) \mathcal{X}'_\alpha((1 - M)^\alpha t) \right)_{t \geq 0},$$

where  $(\mathcal{X}_\alpha(t))_{t \geq 0}$  and  $(\mathcal{X}'_\alpha(t))_{t \geq 0}$  are independent copies of  $(\mathcal{X}_\alpha(t))_{t \geq 0}$ . Here the symbol  $\dot{\cup}$  means that we take the decreasing arrangement of the union of the two sequences.

Elementary calculations show that case 1 occurs with probability  $2/3$  and that conditionally on this event the mass  $M$  of the fragment containing 1 and  $V$  is distributed with density  $3m^2$  on  $[0, 1]$ . Case 2 occurs with probability  $1/3$  and conditionally on that event the mass of the largest fragment has density  $12m(1 - m)$  on  $[1/2, 1]$ . The preceding considerations then show that  $(\mathcal{X}_\alpha(t))_{t \geq 0}$  is a fragmentation process with autosimilarity index  $\alpha$  and dislocation measure  $\nu_D$  given as above.  $\square$

In order to apply Theorem 7.14 to the fragmentation process of Proposition 9.4, we must first calculate the Malthusian exponent associated to  $\nu_D$ . From the definition of  $\nu_D$ , we have for every  $p \geq 0$ ,

$$\kappa_{\nu_D}(p) = 1 - 2 \int_0^1 du u^{p+2} - 4 \int_{1/2}^1 du u(1 - u)(u^p + (1 - u)^p) = \frac{p^2 + 3p - 2}{p^2 + 5p + 6}.$$



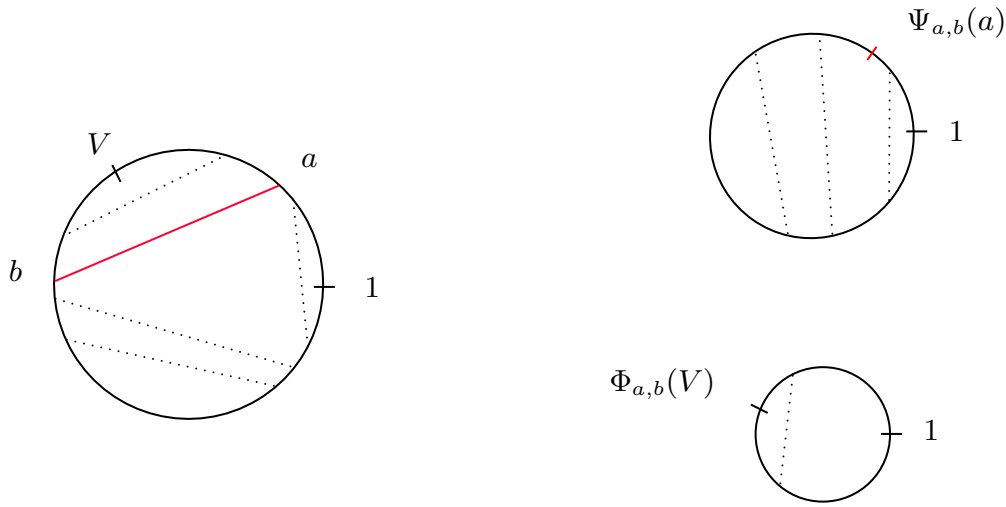

FIGURE 7.4 – Illustration of the proof in the case  $V \in R''$ .

Consequently, the only positive real  $\beta^*$  such that  $\kappa_{\nu_D}(\beta^*) = 0$  is

$$\beta^* = \frac{\sqrt{17} - 3}{2}.$$

We also have  $\kappa_{\nu_D}(0) = -1/3$ .

Let  $x \in \mathbb{S}_1$ . From now on, we will write

$$\mathcal{M}_t^{(\alpha)}(x) = \sum_{i=1}^{\infty} m \left( R_i^{(1,x)}(S_\alpha(t)) \right)^{\beta^*},$$

for the sum of the  $\beta^*$ -th powers of masses of the fragments of  $S_\alpha(t)$  separating  $x$  from 1. This makes sense since both 1 and  $x$  a.s. do not belong to  $\text{Feet}(S_\alpha(t))$ .

By applying Theorem 7.14 to the fragmentation process  $\mathcal{X}_\alpha(t)$ , we get :

**Corollary 7.23.** *Let  $V$  be a random variable uniformly distributed over  $\mathbb{S}_1$  and independent of  $(S_\alpha(t), t \geq 0, \alpha \geq 0)$ . Then :*

- (i) *The process  $\mathcal{M}_t^{(\alpha)}(V)$  is a uniformly integrable martingale and converges almost surely towards a random variable  $\mathcal{M}_\infty^V$  which does not depend on  $\alpha \geq 0$ . Moreover  $\mathcal{M}_\infty^V > 0$  a.s., and  $\mathbb{E} \left[ (\mathcal{M}_\infty^V)^q \right] < \infty$  for every real  $q \geq 1$ .*
- (ii) *For every  $\alpha > 0$ , there exists a constant  $K_{\nu_D}(\alpha)$  such that*

$$t^{-\beta^*/\alpha} H_{S_\alpha(t)}(1, V) \xrightarrow[t \rightarrow \infty]{\mathbb{L}^2} K_{\nu_D}(\alpha) \mathcal{M}_\infty^V.$$

(iii) *There exists a positive random variable  $\mathcal{H}_0^V$  such that*

$$e^{-t/3} H_{S_0(t)}(1, V) \xrightarrow[t \rightarrow \infty]{a.s.} \mathcal{H}_0^V.$$

*More generally, for every  $p \geq 0$ , there exists a positive random variable  $\mathcal{H}_p^V$  such that*

$$e^{t\kappa_{\nu_D}(p)} \sum_{i=0}^{\infty} m \left( R_i^{(1,V)}(S_0(t)) \right)^p \xrightarrow[t \rightarrow \infty]{a.s.} \mathcal{H}_p^V.$$

**Remark 7.24.** The convergence in (ii) can be reinforced in the following way. For every  $\delta \in ]0, 1[$ ,

$$\lim_{t \rightarrow \infty} \mathbb{E} \left[ \sup_{\delta t \leq s \leq t} \left| s^{-\beta^*/\alpha} H_{S_\alpha(s)}(1, V) - K_{\nu_D}(\alpha) \mathcal{M}_\infty^V \right|^2 \right] = 0. \quad (7.6)$$

To see this, fix  $\varepsilon \in ]0, 1[$  and choose a subdivision  $\delta = \delta_0 < \delta_1 < \dots < \delta_k = 1$  of  $[\delta, 1]$  such that  $(\delta_{i+1}/\delta_i)^{\beta^*/\alpha} < 1 + \varepsilon$  for every  $0 \leq i \leq k-1$ . Since the function  $s \mapsto H_{S_\alpha}(s)(1, V)$  is non-decreasing, we have

$$\begin{aligned} & \sup_{\delta t \leq s \leq t} \left( s^{-\beta^*/\alpha} H_{S_\alpha(s)}(1, V) - K_{\nu_D}(\alpha) \mathcal{M}_\infty^V \right) \\ & \leq \sup_{0 \leq i \leq k-1} \left( (\delta_i t)^{-\beta^*/\alpha} H_{S_\alpha(\delta_{i+1}t)}(1, V) - K_{\nu_D}(\alpha) \mathcal{M}_\infty^V \right) \\ & \leq (1 + \varepsilon) \sup_{0 \leq i \leq k-1} \left( (\delta_{i+1}t)^{-\beta^*/\alpha} H_{S_\alpha(\delta_{i+1}t)}(1, V) - K_{\nu_D}(\alpha) \mathcal{M}_\infty^V \right) + \varepsilon K_{\nu_D}(\alpha) \mathcal{M}_\infty^V. \end{aligned}$$

Similar manipulations give

$$\begin{aligned} & \sup_{\delta t \leq s \leq t} \left( K_{\nu_D}(\alpha) \mathcal{M}_\infty^V - s^{-\beta^*/\alpha} H_{S_\alpha(s)}(1, V) \right) \\ & \leq \sup_{0 \leq i \leq k-1} \left( K_{\nu_D}(\alpha) \mathcal{M}_\infty^V - (\delta_{i+1}t)^{-\beta^*/\alpha} H_{S_\alpha(\delta_{i+1}t)}(1, V) \right) \\ & \leq (1 - \varepsilon) \sup_{0 \leq i \leq k-1} \left( K_{\nu_D}(\alpha) \mathcal{M}_\infty^V - (\delta_i t)^{-\beta^*/\alpha} H_{S_\alpha(\delta_i t)}(1, V) \right) + \varepsilon K_{\nu_D}(\alpha) \mathcal{M}_\infty^V. \end{aligned}$$

It follows that

$$\begin{aligned} & \sup_{\delta t \leq s \leq t} \left| s^{-\beta^*/\alpha} H_{S_\alpha(s)}(1, V) - K_{\nu_D}(\alpha) \mathcal{M}_\infty^V \right| \\ & \leq 2 \sup_{0 \leq i \leq k} \left| (\delta_i t)^{-\beta^*/\alpha} H_{S_\alpha(\delta_i t)}(1, V) - K_{\nu_D}(\alpha) \mathcal{M}_\infty^V \right| + \varepsilon K_{\nu_D}(\alpha) \mathcal{M}_\infty^V. \end{aligned}$$

Using property (ii) in Corollary 7.23, we now get

$$\limsup_{t \rightarrow \infty} \mathbb{E} \left[ \sup_{\delta t \leq s \leq t} \left| s^{-\beta^*/\alpha} H_{S_\alpha(s)}(1, V) - K_{\nu_D}(\alpha) \mathcal{M}_\infty^V \right|^2 \right] \leq 2 \varepsilon^2 K_{\nu_D}(\alpha)^2 \mathbb{E} \left[ (\mathcal{M}_\infty^V)^2 \right],$$

and (7.6) follows since  $\varepsilon$  was arbitrary.

### 7.3.4 Fragments separating 1 from a deterministic point

We now aim at an analogue of the last corollary when  $V$  is replaced by a deterministic point  $x$  in  $\mathbb{S}_1$ . We will use the position of the first chord to provide the randomness that we need to reduce the proof to the statement of Corollary 7.23. We start by computing explicitly the distributions of certain quantities that arise when describing the evolution of the process after the creation of the first chord. We use the notation of the beginning of the previous subsection.

We fix  $r \in ]0, 1[$  and write  $x = e^{2i\pi r}$ . Consider first the case when  $x \in R''$ , or equivalently  $U_1 < r < U_2$ . We then set  $Y_1 = \psi_{U_1, U_2}(U_1) = \frac{U_1}{M}$ , which represents the position of the distinguished point, corresponding to the endpoints of the first chord, in the disk obtained from  $R'$  by contracting the first chord. Similarly,  $Y_2 = \phi_{U_1, U_2}(r) = \frac{r - U_1}{1 - M}$  gives the position of the distinguished point corresponding to  $x$  in the the disk obtained from  $R''$  by the same contraction.

In the case when  $r \in ]0, U_1[ \cup ]U_2, 1[$  (or equivalently  $x \in R'$ ), we take  $Y_2 = 0$  and we let  $Y_1 = \psi_{U_1, U_2}(r)$  be the position of the point corresponding to  $x$  in the new disk obtained from  $R'$  by contracting the first chord.

We first evaluate the density of the pair  $(Y_1, Y_2)$  on the event  $\{x \in R''\} = \{U_1 < r < U_2\}$ . We have, for any nonnegative measurable function  $f$  on  $[0, 1]^2$ ,

$$\begin{aligned} & \mathbb{E} \left[ f(Y_1, Y_2) \mathbf{1}_{\{U_1 < r < U_2\}} \right] \\ &= 2 \iint_{[0, 1]^2} du_1 du_2 \mathbf{1}_{\{u_1 < r < u_2\}} f \left( \frac{u_1}{1 - (u_2 - u_1)}, \frac{r - u_1}{u_2 - u_1} \right) \\ &= 2r(1 - r) \int_0^1 \int_0^1 ds_1 ds_2 f \left( \frac{rs_1}{rs_1 + (1 - r)(1 - s_2)}, \frac{r(1 - s_1)}{r(1 - s_1) + (1 - r)s_2} \right). \end{aligned}$$

From the obvious change of variables and after tedious calculations, we get

$$\mathbb{E} \left[ f(Y_1, Y_2) \mathbf{1}_{\{U_1 < r < U_2\}} \right] = 2 \iint_{\mathcal{D}_r} dr_1 dr_2 \frac{|r_1 - r| |r_2 - r|}{|r_1 - r_2|^3} f(r_1, r_2), \quad (7.7)$$

where  $\mathcal{D}_r$  is the set  $\mathcal{D}_r = ([r, 1] \times [0, r]) \cup ([0, r] \times [r, 1])$ . Also note that, on the event  $\{U_1 < r < U_2\}$ , we have  $MY_1 + (1 - M)Y_2 = r$ , and thus  $M = \frac{r - Y_2}{Y_1 - Y_2}$ .

We can similarly compute the distribution of  $Y_1$  on the event  $\{U_1 < U_2 < r\}$ . For any nonnegative measurable function  $f$  on  $[0, 1]$ ,

$$\begin{aligned} \mathbb{E} \left[ f(Y_1) \mathbf{1}_{\{U_1 < U_2 < r\}} \right] &= 2 \iint_{[0, 1]^2} du_1 du_2 \mathbf{1}_{\{u_1 < u_2 < r\}} f \left( \frac{r - (u_2 - u_1)}{1 - (u_2 - u_1)} \right) \\ &= 2r^2 \int_0^1 \int_0^1 ds_1 ds_2 \mathbf{1}_{\{s_1 < s_2\}} f \left( \frac{r(1 - (s_2 - s_1))}{1 - r(s_2 - s_1)} \right) \\ &= 2(1 - r)^2 \int_0^r dr_1 \frac{r_1}{(1 - r_1)^3} f(r_1). \end{aligned} \quad (7.8)$$

Also notice that  $M = \frac{1 - r}{1 - Y_1}$  on the event  $\{U_1 < U_2 < r\}$ .

A similar calculation, or a symmetry argument, shows that the distribution of  $Y_1$  on the event  $\{r < U_1 < U_2\}$  is given by

$$\mathbb{E} \left[ f(Y_1) \mathbf{1}_{\{r < U_1 < U_2\}} \right] = 2r^2 \int_r^1 dr_1 \frac{1-r_1}{r_1^3} f(r_1). \quad (7.9)$$

Note that  $M = \frac{r}{Y_1}$  on  $\{r < U_1 < U_2\}$ .

We can now state and prove the main result of this section.

**Theorem 7.25.** *Let  $x \in \mathbb{S}_1 \setminus \{1\}$ .*

- (i) *For every  $\alpha \geq 0$ , the process  $\mathcal{M}_t^{(\alpha)}(x)$  converges almost surely towards a random variable  $\mathcal{M}_\infty(x)$  which does not depend on  $\alpha$ .*
- (ii) *We have  $\mathcal{M}_\infty(x) > 0$  a.s. and  $\mathbb{E}[\mathcal{M}_\infty(x)^q] < \infty$  for every  $q \geq 1$ .*
- (iii) *For every  $\alpha > 0$ , we have*

$$t^{-\beta^*/\alpha} H_{S_\alpha(t)}(1, x) \xrightarrow[t \rightarrow \infty]{(\mathbb{P})} K_{\nu_D}(\alpha) \mathcal{M}_\infty(x),$$

where the constant  $K_{\nu_D}(\alpha)$  is the same as in Corollary 7.23.

- (iv) *There exists a positive random variable  $\mathcal{H}_0(x)$  such that*

$$e^{-t/3} H_{S_0(t)}(1, x) \xrightarrow[t \rightarrow \infty]{a.s.} \mathcal{H}_0(x).$$

More generally, for every  $p \geq 0$ , there exists a positive random variable  $\mathcal{H}_p(x)$  such that

$$e^{t\kappa_{\nu_D}(p)} \sum_{i=0}^{\infty} m \left( R_i^{(1,x)}(S_0(t)) \right)^p \xrightarrow[t \rightarrow \infty]{a.s.} \mathcal{H}_p(x).$$

*Démonstration.* As previously, we write  $x = e^{2i\pi r}$ , where  $r \in ]0, 1[$ . To simplify notation, we also set, for every  $t \geq 0$ , and every  $\alpha \geq 0$ ,

$$\mathcal{X}_\alpha^x(t) = \left( m \left( R_1^{(1,x)}(S_\alpha(t)) \right), m \left( R_2^{(1,x)}(S_\alpha(t)) \right), \dots \right).$$

Fix  $\alpha \geq 0$ . Consider first the case when  $x$  belongs to  $R'$ . After time  $\tau$ , the fragments separating 1 from  $x$  will correspond to fragments separating 1 from  $\Psi_{a,b}(x)$  in the disk obtained from  $R'$  by contracting the first chord. If  $F$  is a nonnegative measurable function on the Skorokhod space  $\mathbb{D}([0, \infty[, \mathcal{S}^\downarrow)$ , Lemma 7.19 gives

$$\mathbb{E} \left[ F \left( (\mathcal{X}_\alpha^x(\tau + t))_{t \geq 0} \right) \mathbf{1}_{\{x \in R'\}} \right] = \mathbb{E} \left[ F \left( (M \tilde{\mathcal{X}}_\alpha^{\Psi_{a,b}(x)}(M^\alpha t))_{t \geq 0} \right) \mathbf{1}_{\{x \in R'\}} \right], \quad (7.10)$$

where, for every  $y \in \mathbb{S}_1 \setminus \{1\}$ , the process  $(\tilde{\mathcal{X}}_\alpha^y(t))_{t \geq 0}$  is defined from an independent copy  $(\tilde{S}_\alpha(t))_{t \geq 0}$  of  $(S_\alpha(t))_{t \geq 0}$ , in the same way as  $(\mathcal{X}_\alpha^y(t))_{t \geq 0}$  is defined from  $(S_\alpha(t))_{t \geq 0}$ . Note that  $\Psi_{a,b}(x) = \exp(2i\pi Y_1)$  in the notation introduced before the theorem. From formulas (7.8) and (7.9) and the relations between  $M$  and  $Y_1$ , we get

$$\begin{aligned} & \mathbb{E} \left[ F \left( (\mathcal{X}_\alpha^x(\tau + t))_{t \geq 0} \right) \mathbf{1}_{\{x \in R'\}} \right] \\ &= 2(1-r)^2 \int_0^r dr_1 \frac{r_1}{(1-r_1)^3} \mathbb{E} \left[ F \left( \left( \left( \frac{1-r}{1-r_1} \right) \tilde{\mathcal{X}}_\alpha^{\exp(2i\pi r_1)} \left( \left( \frac{1-r}{1-r_1} \right)^\alpha t \right) \right)_{t \geq 0} \right) \right] \\ &+ 2r^2 \int_r^1 dr_1 \frac{1-r_1}{r_1^3} \mathbb{E} \left[ F \left( \left( \left( \frac{r}{r_1} \right) \tilde{\mathcal{X}}_\alpha^{\exp(2i\pi r_1)} \left( \left( \frac{r}{r_1} \right)^\alpha t \right) \right)_{t \geq 0} \right) \right]. \end{aligned}$$

Let  $U$  be uniformly distributed over  $[0, 1]$  and independent of  $(\tilde{S}_\alpha(t))_{t \geq 0}$ . By the preceding display, the conditional distribution of  $(\mathcal{X}_\alpha^x(\tau+t))_{t \geq 0}$  given that  $x \in R'$  is absolutely continuous (even with a bounded density) with respect to that of the process

$$\left( \mathbf{1}_{\{U < r\}} \frac{1-r}{1-U} \tilde{\mathcal{X}}_\alpha^{\exp(2i\pi U)} \left( \left( \frac{1-r}{1-U} \right)^\alpha t \right) + \mathbf{1}_{\{U > r\}} \frac{r}{U} \tilde{\mathcal{X}}_\alpha^{\exp(2i\pi U)} \left( \left( \frac{r}{U} \right)^\alpha t \right) \right)_{t \geq 0}.$$

Since  $V = \exp(2i\pi U)$  is uniformly distributed on  $\mathbb{S}_1$  and independent of  $(\tilde{S}_\alpha(t))_{t \geq 0}$ , we can apply Corollary 7.23 to get asymptotics for the process in the last display. It follows that the almost sure convergences in parts (i) and (iv) of the proposition hold on the event  $\{x \in R'\}$ . Moreover the variable  $\mathcal{M}_\infty(x)$  obtained as the almost sure limit of  $\mathcal{M}_t^{(\alpha)}(x)$  (only on the event  $\{x \in R'\}$  for the moment) does not depend on the choice of  $\alpha \geq 0$ . To see this, note that if we fix two values  $\alpha \geq 0$  and  $\alpha' \geq 0$ , the preceding absolute continuity property holds in a similar form for the pair  $((\mathcal{X}_\alpha^x(\tau+t))_{t \geq 0}, (\mathcal{X}_{\alpha'}^x(\tau+t))_{t \geq 0})$ . Then it suffices to use the fact that the limiting variable  $\mathcal{M}_\infty^V$  in Corollary 7.23 (i) does not depend on the choice of  $\alpha \geq 0$ .

The justification of property (iii) of the proposition (still on the event  $\{x \in R'\}$ ) is a bit trickier because we do not have almost sure convergence in Corollary 7.23 (ii). We need the reinforced version of Corollary 7.23 (ii) provided by Remark 7.24. We observe that, if  $U > r$ , the quantity  $(r/U)^\alpha$  is bounded above by 1 and bounded below by  $r^\alpha$ , so that (7.6) gives

$$t^{-\beta^*/\alpha} H_{\tilde{S}_\alpha((r/U)^\alpha t)}(1, \exp(2i\pi U)) \xrightarrow[t \rightarrow \infty]{(\mathbb{L}^2)} \left( \frac{r}{U} \right)^{\beta^*} K_{\nu_D}(\alpha) \tilde{\mathcal{M}}_\infty^V$$

on the event  $\{U > r\}$  (with an obvious notation for  $\tilde{\mathcal{M}}_\infty^V$ ). A similar observation holds for the asymptotics of  $H_{\tilde{S}_\alpha(((1-r)/(1-U))^\alpha t)}(1, \exp(2i\pi U))$  on the event  $\{U < r\}$ . By combining both asymptotics and using the absolute continuity relation mentioned above, we get that the convergence in probability in assertion (iii) of the proposition holds on the event  $\{x \in R'\}$ .

Let us turn to the case where  $x$  belongs to  $R''$ . From Lemma 7.19, we have

$$\begin{aligned} & \mathbb{E} \left[ F((\mathcal{X}_\alpha^x(\tau+t))_{t \geq 0}) \mathbf{1}_{\{x \in R''\}} \right] \\ &= \mathbb{E} \left[ F \left( \left( M \tilde{\mathcal{X}}_\alpha^{\Psi_{a,b}(a)}(M^\alpha t) \dot{\cup} (1-M) \bar{\mathcal{X}}_\alpha^{\Phi_{a,b}(x)}((1-M)^\alpha t) \right)_{t \geq 0} \right) \mathbf{1}_{\{x \in R''\}} \right], \end{aligned} \tag{7.11}$$

where  $\tilde{X}_\alpha^y$  and  $\bar{X}_\alpha^y$  are defined in terms of two independent copies  $\tilde{S}_\alpha$  and  $\bar{S}_\alpha$  of  $S_\alpha$  (and the notation  $\dot{\cup}$  has the same meaning as in the proof of Proposition 9.4).

Using now formula (7.7), we obtain

$$\begin{aligned} & \mathbb{E} \left[ F((\mathcal{X}_\alpha^x(\tau+t))_{t \geq 0}) \mathbf{1}_{\{x \in R''\}} \right] \\ &= 2 \iint_{\mathcal{D}_r} dr_1 dr_2 \frac{|r_1 - r| |r_2 - r|}{|r_1 - r_2|^3} \\ & \quad \times \mathbb{E} \left[ F \left( \left( \left( \frac{r-r_2}{r_1-r_2} \right) \tilde{\mathcal{X}}_\alpha^{\exp(2i\pi r_1)} \left( \left( \frac{r-r_2}{r_1-r_2} \right)^\alpha t \right) \dot{\cup} \left( \frac{r_1-r}{r_1-r_2} \right) \bar{\mathcal{X}}_\alpha^{\exp(2i\pi r_2)} \left( \left( \frac{r_1-r}{r_1-r_2} \right)^\alpha t \right) \right)_{t \geq 0} \right) \right]. \end{aligned}$$

Hence, if  $U$  and  $U'$  are two independent variables uniformly distributed over  $[0, 1]$  and independent of  $(\tilde{S}_\alpha, \bar{S}^\alpha)$ , the distribution of  $(\mathcal{X}_\alpha^x(\tau + t))_{t \geq 0}$  knowing that  $x \in R''$  is absolutely continuous with respect to the distribution of

$$\left( \left( \frac{r - U'}{U - U'} \right) \tilde{\mathcal{X}}_\alpha^{\exp(2i\pi U)} \left( \left( \frac{r - U'}{U - U'} \right)^\alpha t \right) \cup \left( \frac{U - r}{U - U'} \right) \bar{\mathcal{X}}_\alpha^{\exp(2i\pi U')} \left( \left( \frac{U - r}{U - U'} \right)^\alpha t \right) \right)_{t \geq 0}$$

conditionally on  $(U - r)(U' - r) < 0$ . As in the case  $x \in R'$ , we see that the almost sure convergences in assertions (i) and (iv) of the proposition, on the event  $\{x \in R''\}$ , follow from the analogous convergences in Corollary 7.23. By the same argument as in the case  $x \in R'$ , the almost sure limit  $\mathcal{M}_\infty(x)$  in (i) does not depend on the choice of  $\alpha \geq 0$ .

To get the convergence in probability in assertion (iii), we again use Remark 7.24. The point is that the quantities  $((r - U')/(U - U'))^\alpha$  and  $((U - r)/(U - U'))^\alpha$ , which are bounded above by 1 (recall that we condition on  $(U - r)(U' - r) < 0$ ), are also bounded below by  $\delta > 0$  except on a set of small probability. As in the case  $x \in R'$ , the desired result follows from (7.6).

It remains to prove (ii). The property  $\mathcal{M}_\infty(x) > 0$  a.s. is immediate from the analogous property in Corollary 7.23 and our absolute continuity argument. Then, by applying formulas (7.10) and (7.11) with a suitable choice of the function  $F$ , we get, for every nonnegative measurable function  $f$  on  $\mathbb{R}_+$ ,

$$\begin{aligned} & \mathbb{E}[f(\mathcal{M}_\infty(x))] \\ &= \mathbb{E}\left[f(\mathcal{M}_\infty(x))\mathbf{1}_{\{x \in R'\}}\right] + \mathbb{E}\left[f(\mathcal{M}_\infty(x))\mathbf{1}_{\{x \in R''\}}\right] \\ &= \mathbb{E}\left[f(M^{\beta^*} \tilde{\mathcal{M}}_\infty(e^{2i\pi Y_1}))\mathbf{1}_{\{x \in R'\}}\right] + \mathbb{E}\left[f(M^{\beta^*} \tilde{\mathcal{M}}_\infty(e^{2i\pi Y_1}) + (1 - M)^{\beta^*} \bar{\mathcal{M}}_\infty(e^{2i\pi Y_2}))\mathbf{1}_{\{x \in R''\}}\right], \end{aligned}$$

where  $\tilde{\mathcal{M}}_\infty$  and  $\bar{\mathcal{M}}_\infty$  are the obvious analogues of  $\mathcal{M}_\infty$  when  $S_\alpha$  is replaced by  $\tilde{S}_\alpha$  and  $\bar{S}_\alpha$  respectively. Set  $\mathcal{M}_\infty(1) = 0$ . We have obtained the identity in distribution

$$\mathcal{M}_\infty(x) \stackrel{(d)}{=} M^{\beta^*} \mathcal{M}'_\infty(e^{2i\pi Y_1}) + (1 - M)^{\beta^*} \mathcal{M}''_\infty(e^{2i\pi Y_2}), \tag{7.12}$$

where  $\mathcal{M}'_\infty$  and  $\mathcal{M}''_\infty$  are two independent copies of  $\mathcal{M}_\infty$  and the pair  $(\mathcal{M}'_\infty, \mathcal{M}''_\infty)$  is also independent of  $(Y_1, Y_2)$ . However, from the explicit formulas (7.7), (7.8) and (7.9), it is easy to verify that both the density of the law of  $Y_1$  and the density of the law of  $Y_2$  conditional on  $\{Y_2 \neq 0\}$  are bounded above by a constant depending on  $x$ . By Corollary 7.23 we know that, if  $U$  is uniformly distributed over  $[0, 1]$  and independent of the figela process, we have  $\mathbb{E}[\mathcal{M}_\infty(e^{2i\pi U})^q] < \infty$  for every  $q \geq 1$ . The analogous property for  $\mathcal{M}_\infty(x)$  then follows from (7.12) and the preceding observations.  $\square$

**Remark 7.26.** By rotational invariance of the model, the point 1 can be replaced by any point of  $\mathbb{S}_1$  in Theorem 7.25.

## 7.4 Estimates for moments and the continuity of the height process

### 7.4.1 Estimates for moments

We first state a proposition giving estimates for the moments of the increments of the process  $\mathcal{M}_\infty(x)$ . These estimates will allow us to apply Kolmogorov’s continuity criterion in order to get information on the Hölder continuity properties of this process. Recall that we take  $\mathcal{M}_\infty(1) = 0$  by convention.

**Proposition 7.27.** *For every  $\varepsilon > 0$  and every integer  $p \geq 1$ , there exists a constant  $M_{\varepsilon,p} \geq 0$  such that, for every  $u \in [0, 1]$  we have*

$$\mathbb{E} \left[ \mathcal{M}_\infty(e^{2i\pi u})^p \right] \leq M_{\varepsilon,p} (u(1-u))^{p\beta^* - \varepsilon}.$$

In the special case  $p = 1$ , we have

$$\mathbb{E} \left[ \mathcal{M}_\infty(e^{2i\pi u}) \right] = \frac{\Gamma(2 + 2\beta^*)}{\Gamma(1 + \beta^*)^2} (u(1-u))^{\beta^*}.$$

The proof of the proposition is given in the next two subsections. This proof relies on the identity in distribution (7.12) derived in the preceding proof. Using this identity and formulas (7.7), (7.8) and (7.9), we will obtain integral equations for the moments of  $(\mathcal{M}_\infty(x), x \in \mathbb{S}_1)$ . We can explicitly solve the integral equation corresponding to the first moment. We then use Gronwall’s lemma to investigate the behavior of higher moments when  $x \in \mathbb{S}_1$  is close to 1.

For every integer  $p \geq 1$  and every  $r \in [0, 1]$ , we set

$$m_p(r) = \mathbb{E} \left[ \mathcal{M}_\infty(e^{2i\pi r})^p \right].$$

### 7.4.2 The case $p = 1$

Let  $r \in ]0, 1[$ . Thanks to the identity in distribution (7.12) and to formulas (7.7), (7.8) and (7.9), we obtain the integral equation

$$\begin{aligned} m_1(r) = & 2(1-r)^2 \int_0^r dr_1 \frac{r_1}{(1-r_1)^3} \left( \frac{1-r}{1-r_1} \right)^{\beta^*} m_1(r_1) + 2r^2 \int_r^1 dr_1 \frac{1-r_1}{r_1^3} \left( \frac{r}{r_1} \right)^{\beta^*} m_1(r_1) \\ & + 2 \iint_{\mathcal{D}_r} dr_1 dr_2 \frac{|r_1-r||r_2-r|}{|r_1-r_2|^3} \left( \left( \frac{r-r_2}{r_1-r_2} \right)^{\beta^*} m_1(r_1) + \left( \frac{r_1-r}{r_1-r_2} \right)^{\beta^*} m_1(r_2) \right). \end{aligned} \tag{7.13}$$

We can rewrite the first two terms in the sum of the right-hand side in the form

$$2 \int_0^r dr_1 \left( \frac{1}{1-r_1} - 1 \right) \left( \frac{1-r}{1-r_1} \right)^{\beta^*+2} m_1(r_1) + 2 \int_r^1 dr_1 \left( \frac{1}{r_1} - 1 \right) \left( \frac{r}{r_1} \right)^{\beta^*+2} m_1(r_1).$$

As for the third term, we observe that

$$\begin{aligned} & \int_0^r dr_1 \int_r^1 dr_2 \frac{(r-r_1)(r_2-r)}{(r_2-r_1)^3} \left(\frac{r_2-r}{r_2-r_1}\right)^{\beta^*} m_1(r_1) \\ &= \int_0^r dr_1 m_1(r_1)(r-r_1) \int_r^1 dr_2 \left(\frac{1}{r_2-r_1}\right)^2 \left(\frac{r_2-r}{r_2-r_1}\right)^{\beta^*+1} \\ &= \int_0^r dr_1 m_1(r_1) \frac{1}{\beta^*+2} \left(\frac{1-r}{1-r_1}\right)^{\beta^*+2}, \end{aligned}$$

where we made the change of variables  $u = \frac{r_2-r}{r_2-r_1}$  to compute the integral in  $dr_2$ . It follows that the third term in the right-hand side of (7.13) is equal to

$$\frac{4}{\beta^*+2} \left( \int_0^r dr_1 \left(\frac{1-r}{1-r_1}\right)^{\beta^*+2} m_1(r_1) + \int_r^1 dr_1 \left(\frac{r}{r_1}\right)^{\beta^*+2} m_1(r_1) \right).$$

Summarizing, we obtain that the function  $(m_1(r), r \in ]0, 1[)$  solves the integral equation

$$m_1(r) = \int_0^1 du g_r(u) m_1(u) \tag{7.14}$$

where, for every  $r \in ]0, 1[$ ,

$$g_r(u) = \mathbf{1}_{\{0 < u < r\}} \left(\frac{1-r}{1-u}\right)^{2+\beta^*} \left(\frac{2}{1-u} - \frac{2\beta^*}{\beta^*+2}\right) + \mathbf{1}_{\{r \leq u < 1\}} \left(\frac{r}{u}\right)^{2+\beta^*} \left(\frac{2}{u} - \frac{2\beta^*}{\beta^*+2}\right),$$

is a positive function on  $]0, 1[$ . Elementary calculations, using the fact that  $(\beta^*)^2 + 3\beta^* - 2 = 0$ , show that  $\int_0^1 g_r(u) dr = 1$ , for every  $u \in ]0, 1[$ .

Let  $N$  be the operator that maps a function  $f \in \mathbb{L}^1(]0, 1[, dr)$  to the function

$$N(f)(r) = \int_0^1 du g_r(u) f(u).$$

Then  $N$  is a contraction : If  $f_1, f_2 \in \mathbb{L}^1(]0, 1[, dr)$ , we have

$$\int_0^1 dr |N(f_1)(r) - N(f_2)(r)| \leq \int_0^1 dr \int_0^1 du g_r(u) |f_1(u) - f_2(u)| = \int_0^1 du |f_1(u) - f_2(u)|.$$

The first inequality in the last display is strict unless  $f_1 - f_2$  has a.e. a constant sign. It follows that there can be at most one nonnegative function  $f \in \mathbb{L}^1(]0, 1[, dr)$  such that  $\int_0^1 dr f(r) = 1$  and  $f$  is a fixed point of  $N$ .

By (7.14),  $m_1$  is a fixed point of  $N$ . Furthermore, if  $V$  is uniformly distributed over  $\mathbb{S}_1$  and independent of  $\mathcal{M}_\infty$ , we know from Corollary 7.23 that  $\mathcal{M}_\infty(V)$  is the limit of the uniformly integrable martingale  $\mathcal{M}_t^{(\alpha)}(V)$  (for any choice of  $\alpha \geq 0$ ) and therefore  $\mathbb{E}[\mathcal{M}_\infty(V)] = 1$ . Hence,

$$\int_0^1 dr m_1(r) = \int_0^1 dr \mathbb{E}[\mathcal{M}_\infty(e^{2i\pi r})] = \mathbb{E}[\mathcal{M}_\infty(V)] = 1.$$



We conclude that the function  $f = m_1$  is the unique nonnegative function in  $\mathbb{L}^1(]0, 1[, dr)$  such that  $\int_0^1 dr f(r) = 1$  and  $f$  is a fixed point of  $N$ . On the other hand, elementary calculus shows that the function  $r \mapsto (r(1-r))^{\beta^*}$  is also a fixed point of  $N$ . Indeed, noting that  $2\beta^*/(\beta^* + 2) = 1 - \beta^*$  and using two integration by parts, we get

$$\int_0^r \left(\frac{1-r}{1-u}\right)^{2+\beta^*} \left(\frac{2}{1-u} - \frac{2\beta^*}{\beta^*+2}\right) (u(1-u))^{\beta^*} du = r^{1+\beta^*} (1-r)^{\beta^*}$$

and similarly,

$$\int_r^1 \left(\frac{r}{u}\right)^{2+\beta^*} \left(\frac{2}{u} - \frac{2\beta^*}{\beta^*+2}\right) (u(1-u))^{\beta^*} du = r^{\beta^*} (1-r)^{\beta^*+1}.$$

Therefore, the function

$$e_{\beta^*}(r) := \frac{\Gamma(2+2\beta^*)}{\Gamma(1+\beta^*)^2} (r(1-r))^{\beta^*}$$

is also a fixed point of  $N$  such that  $\int_0^1 dr e_{\beta^*}(r) = 1$ . Consequently we have  $m_1(r) = e_{\beta^*}(r)$  a.e. The equality is in fact true for every  $r \in ]0, 1[$  since the integral equation (7.14) implies that  $m_1$  is continuous on  $]0, 1[$ . This completes the proof of Proposition 7.27 in the case  $p = 1$ .

### 7.4.3 The case $p \geq 2$

From the Hölder inequality, and the case  $p = 1$ , we have for every integer  $p \geq 1$  and every  $r \in ]0, 1[$ ,

$$m_p(r) \geq \left(\frac{\Gamma(2+2\beta^*)}{\Gamma(1+\beta^*)^2}\right)^p (r(1-r))^{p\beta^*}. \tag{7.15}$$

We prove by induction on  $k \geq 1$ , that for every  $\varepsilon \in ]0, 1/2[$ , there exists a constant  $M_{\varepsilon,k} > 0$  such that for every  $r \in ]0, 1[$ ,

$$m_k(r) \leq M_{\varepsilon,k} (r(1-r))^{k\beta^*-\varepsilon}. \tag{7.16}$$

We assume that (7.16) holds for  $k = 1, 2, \dots, p-1$ , and we prove that this bound also holds for  $k = p$ .

Similarly as in the case  $p = 1$ , we can use the identity in distribution (7.12) to get the following integral equation for the functions  $m_p$  :

$$\begin{aligned} m_p(r) &= \int_0^r du \left(\frac{1-r}{1-u}\right)^{2+p\beta^*} \left(\frac{2}{1-u} - \frac{2p\beta^*}{p\beta^*+2}\right) m_p(u) \\ &+ \int_r^1 du \left(\frac{r}{u}\right)^{2+p\beta^*} \left(\frac{2}{u} - \frac{2p\beta^*}{p\beta^*+2}\right) m_p(u) \\ &+ 2 \sum_{k=1}^{p-1} \binom{p}{k} \iint_{\mathcal{D}_r} dr_1 dr_2 \frac{|r_1-r|^{1+(p-k)\beta^*} |r_2-r|^{1+k\beta^*}}{|r_1-r_2|^{3+p\beta^*}} m_k(r_1) m_{p-k}(r_2). \end{aligned} \tag{7.17}$$

The derivation of (7.17) from (7.12) is exactly similar to that of (7.14), and we leave details to the reader. Note that, in contrast with the case  $p = 1$ , we now get “interaction terms” involving the products  $m_k(r) m_{p-k}(r)$ . We start with some crude estimates.

**Lemma 7.28.** *For every  $p \geq 1$ , the function  $m_p$  is bounded over  $]0, 1[$ . Moreover, for every  $u, r \in ]0, 1/2[$ , we have*

$$m_p(u) \leq 2^{p-1}(m_p(u+r) + m_p(r)). \tag{7.18}$$

*Démonstration.* For every  $r, u \in ]0, 1[$ , we set

$$g_{p,r}(u) = \mathbf{1}_{\{0 < u < r\}} \left( \frac{1-r}{1-u} \right)^{2+p\beta^*} \left( \frac{2}{1-u} - \frac{2p\beta^*}{p\beta^*+2} \right) + \mathbf{1}_{\{r < u < 1\}} \left( \frac{r}{u} \right)^{2+\beta^*} \left( \frac{2}{u} - \frac{2p\beta^*}{\beta^*+2} \right).$$

From (7.17), we have

$$m_p(r) \geq \int_0^1 du g_{p,r}(u) m_p(u).$$

On the other hand, by using (7.12) and the inequality  $(a+b)^p \leq 2^{p-1}(a^p + b^p)$  for  $a, b \geq 0$ , we get

$$m_p(r) \leq 2^{p-1} \left( \mathbb{E} \left[ M^{p\beta^*} \mathcal{M}'_{\infty}(e^{2i\pi Y_1})^p \right] + \mathbb{E} \left[ (1-M)^{p\beta^*} \mathcal{M}''_{\infty}(e^{2i\pi Y_2})^p \right] \right) = 2^{p-1} \int_0^1 du g_{p,r}(u) m_p(u),$$

where the last equality again follows from calculations similar to those leading to (7.14).

From the explicit form of the function  $g_{p,r}$ , we see that, for every  $\delta \in ]0, 1/2[$ , there exist positive constants  $c_{\delta,p}$  and  $C_{\delta,p}$  such that for all  $r \in ]\delta, 1-\delta[$ ,

$$c_{\delta,p} \int_0^1 m_p(u) du \leq m_p(r) \leq C_{\delta,p} \int_0^1 m_p(u) du. \tag{7.19}$$

If  $U$  is uniformly distributed over  $[0, 1]$ , Corollary 7.23 shows that  $\int_0^1 m_p(u) du = \mathbb{E}[\mathcal{M}_{\infty}(U)^p] < \infty$ . We thus get that the function  $m_p$  is bounded over every compact subset of  $]0, 1[$ .

To get information about the values of the function  $m_p$  in the neighborhood of 0 (or of 1), we use the triangle inequality for figelas. Let  $\alpha > 0$ . For every  $r, u \in ]0, 1/2[$  and every  $t \geq 0$ , Proposition 7.7 gives

$$H_{S_{\alpha}(t)}(1, e^{2i\pi u}) \leq H_{S_{\alpha}(t)}(1, e^{2i\pi(u+r)}) + H_{S_{\alpha}(t)}(e^{2i\pi u}, e^{2i\pi(u+r)}).$$

Furthermore, rotational invariance shows that the process  $(H_{S_{\alpha}(t)}(e^{2i\pi u}, e^{2i\pi(u+r)}))_{t \geq 0}$  has the same distribution as the process  $(H_{S_{\alpha}(t)}(1, e^{2i\pi r}))_{t \geq 0}$ . We thus deduce from Theorem 7.25 (iii) that

$$\mathcal{M}_{\infty}(e^{2i\pi u}) \leq \mathcal{M}_{\infty}(e^{2i\pi(u+r)}) + \tilde{\mathcal{M}}_{\infty}(e^{2i\pi r}),$$

where  $\tilde{\mathcal{M}}_{\infty}(e^{2i\pi r})$  has the same distribution as  $\mathcal{M}_{\infty}(e^{2i\pi r})$ . The bound (7.18) now follows by using the inequality  $(a+b)^p \leq 2^{p-1}(a^p + b^p)$  for  $a, b \geq 0$ .

Since we already know that the function  $m_p$  is bounded over compact subsets of  $]0, 1[$ , and since  $m_p(r) = m_p(1-r)$  by an obvious symmetry argument, the bound (7.18) implies that  $m_p$  is bounded over  $]0, 1[$ .  $\square$

We come back to the proof of (7.16) with  $k = p$ . We fix  $\varepsilon \in ]0, 1/8[$ . We start from the integral equation (7.17) and first discuss the interaction terms. Fix  $k \in \{1, 2, \dots, p-1\}$  and set, for every  $r \in ]0, 1[$ ,

$$T_{p,k}(r) = \iint_{\mathcal{D}_r} dr_1 dr_2 \frac{|r_1 - r|^{1+(p-k)\beta^*} |r_2 - r|^{1+k\beta^*}}{|r_1 - r_2|^{3+p\beta^*}} m_k(r_1) m_{p-k}(r_2).$$

By the induction hypothesis, there exists a constant  $M_{p,k,\varepsilon}$  such that, for  $r \in ]0, 1[$ ,

$$T_{p,k}(r) \leq M_{p,k,\varepsilon} \iint_{\mathcal{D}_r} dr_1 dr_2 \frac{|r_1 - r|^{1+(p-k)\beta^*} |r_2 - r|^{1+k\beta^*}}{|r_1 - r_2|^{3+p\beta^*}} r_1^{k\beta^* - \varepsilon} r_2^{(p-k)\beta^* - \varepsilon}.$$

Consider the integral over  $[0, r] \times [r, 1]$ . From the change of variables  $r_1 = rs_1$  and  $r_2 = rs_2$ , we see that this integral is equal to

$$r^{p\beta^* + 1 - 2\varepsilon} \int_0^1 ds_1 \int_1^{1/r} ds_2 \frac{(1-s_1)^{1+(p-k)\beta^*} (s_2-1)^{1+k\beta^*}}{(s_2-s_1)^{3+p\beta^*}} s_1^{k\beta^* - \varepsilon} s_2^{(p-k)\beta^* - \varepsilon} \leq K r^{p\beta^* + 1 - 2\varepsilon},$$

where

$$K = \int_0^1 ds_1 \int_1^\infty ds_2 \frac{(1-s_1)^{1+(p-k)\beta^*} (s_2-1)^{1+k\beta^*}}{(s_2-s_1)^{3+p\beta^*}} s_2^{(p-k)\beta^* - \varepsilon} < \infty.$$

We get a similar bound for the integral over  $[r, 1] \times [0, r]$  and, using the fact that  $m_p(r) = m_p(1-r)$ , we conclude that the “interaction terms” in the integral equation (7.17) are bounded above by a constant times  $(r(1-r))^{p\beta^* + 1/2}$ . By (7.15) these terms are negligible in comparison with  $m_p(r)$  when  $r \rightarrow 0$ .

Thus for  $r$  sufficiently close to 0, say  $0 < r \leq r_0 \leq 1/4$ , we can write

$$\begin{aligned} m_p(r) &\leq (1+\varepsilon) \int_0^r du \left(\frac{1-r}{1-u}\right)^{2+p\beta^*} \left(\frac{2}{1-u} - \frac{2p\beta^*}{p\beta^*+2}\right) m_p(u) \\ &\quad + (1+\varepsilon) \int_r^1 du \left(\frac{r}{u}\right)^{2+p\beta^*} \left(\frac{2}{u} - \frac{2p\beta^*}{p\beta^*+2}\right) m_p(u). \end{aligned}$$

The first term in the right-hand side is easily bounded by  $6 \int_0^r du m_p(u)$ , and we have, for  $0 < r \leq r_0$ ,

$$m_p(r) \leq 6 \int_0^r du m_p(u) + (1+\varepsilon) \int_r^1 du \left(\frac{r}{u}\right)^{2+p\beta^*} \left(\frac{2}{u} - \frac{2p\beta^*}{p\beta^*+2}\right) m_p(u). \quad (7.20)$$

However, by the inequality (7.18), we have for  $0 < r \leq r_0$ ,

$$\int_0^r du m_p(u) \leq 2^{p-1} \left( r m_p(r) + \int_r^{2r} du m_p(u) \right). \quad (7.21)$$

By (7.17), we have also

$$m_p(r) \geq \int_r^{2r} du \left(\frac{r}{u}\right)^{2+p\beta^*} \left(\frac{2}{u} - \frac{2p\beta^*}{p\beta^*+2}\right) m_p(u)$$

and since  $\frac{2}{u}$  tends to infinity as  $u \rightarrow 0$ , this bound shows that  $\int_r^{2r} du m_p(u)$  is negligible in comparison with  $m_p(r)$  when  $r \rightarrow 0$ . Therefore, from the bound (7.21) and by choosing  $r_0$  smaller if necessary, we can assume that, for  $0 < r \leq r_0$ ,

$$6 \int_0^r du m_p(u) \leq \left(1 - \frac{1 + \varepsilon}{1 + 2\varepsilon}\right) m_p(r).$$

By substituting this estimate in (7.20), we get for  $0 < r \leq r_0$ ,

$$m_p(r) \leq (1 + 2\varepsilon) \int_r^1 du \left(\frac{r}{u}\right)^{2+p\beta^*} \left(\frac{2}{u} - \frac{2p\beta^*}{p\beta^* + 2}\right) m_p(u).$$

Consequently, there exists a positive constant  $K = K(r_0, p, \varepsilon)$  such that for  $0 < r \leq r_0$ ,

$$\frac{m_p(r)}{r^{2+p\beta^*}} \leq K + 2(1 + 2\varepsilon) \int_r^{r_0} \frac{du}{u} \frac{m_p(u)}{u^{2+p\beta^*}}.$$

A straightforward application of Gronwall’s lemma to the function  $r \rightarrow r^{-2-p\beta^*} m_p(r)$  gives for  $0 < r \leq r_0$ ,

$$\frac{m_p(r)}{r^{2+p\beta^*}} \leq K \left(\frac{r_0}{r}\right)^{2(1+2\varepsilon)},$$

or equivalently

$$m_p(r) \leq K r_0^{2(1+2\varepsilon)} r^{p\beta^* - 4\varepsilon}.$$

Since  $\varepsilon \in ]0, 1/8[$  was arbitrary, and since we have  $m_p(r) = m_p(1 - r)$  for  $r \in ]0, 1[$ , we have obtained the desired bound (7.16) at order  $p$ . This completes the proof of Proposition 7.27.

#### 7.4.4 Proof of Theorem 7.1

The asymptotics in Theorem 7.1 are consequences of the more general results obtained in Corollary 7.18 (ii) and in Theorem 7.25 (iii), using also Remark 7.11. It remains to verify that the process  $(\mathcal{M}_\infty(x), x \in \mathbb{S}_1)$  has a Hölder continuous modification. Let  $x$  and  $y$  be two distinct points of  $\mathbb{S}_1 \setminus \{0\}$ , and let  $\alpha > 0$ . By the triangle inequality in Proposition 7.7, we have for every  $t \geq 0$ ,

$$|H_{S_\alpha(t)}(1, x) - H_{S_\alpha(t)}(1, y)| \leq H_{S_\alpha(t)}(x, y)$$

and  $H_{S_\alpha(t)}(x, y)$  has the same distribution as  $H_{S_\alpha(t)}(1, x^{-1}y)$  by rotational invariance. We can let  $t \rightarrow \infty$  and using Theorem 7.25 (iii), we get the following stochastic inequality

$$|\mathcal{M}_\infty(e^{2i\pi r}) - \mathcal{M}_\infty(e^{2i\pi s})| \stackrel{(d)}{\leq} \mathcal{M}_\infty(e^{2i\pi(r-s)}). \tag{7.22}$$

for every  $0 \leq s < r < 1$ .

By Proposition 7.27, we have then for every integer  $p \geq 1$  and every  $0 \leq s < r < 1$ ,

$$\mathbb{E} \left[ |\mathcal{M}_\infty(e^{2i\pi r}) - \mathcal{M}_\infty(e^{2i\pi s})|^p \right] \leq M_{\varepsilon, p} (r - s)^{p\beta^* - \varepsilon}.$$

Kolmogorov’s continuity criterion (see [123, Theorem 1.8]) shows that the process  $(\mathcal{M}_\infty(x), x \in \mathbb{S}_1)$  has a continuous modification, which is even  $(\beta^* - \varepsilon)$ -Hölder continuous, for every  $\varepsilon > 0$ .  $\square$

From now on, we only deal with the continuous modification of the process  $(\mathcal{M}_\infty(x), x \in \mathbb{S}_1)$ . Recall the notation  $\mathcal{T}_S$  for the plane tree associated with a figela  $S$ , and also recall that  $H_S$  corresponds to the graph distance on this tree. One may ask about the convergence of the (suitably rescaled) trees  $\mathcal{T}_{S_\alpha(t)}$  in the sense of the Gromov-Hausdorff distance. Recall the notation  $T_g$  for the  $\mathbb{R}$ -tree coded by a function  $g$  (see subsection 7.2.3).

CONJECTURE. Set  $g_\infty(r) = \mathcal{M}_\infty(e^{2i\pi r})$  for every  $r \in [0, 1]$ . The convergence in distribution

$$\left(\mathcal{T}_{S_\alpha(t)}, t^{-\beta^*/\alpha} H_{S_\alpha(t)}\right) \xrightarrow[t \rightarrow \infty]{(d)} (T_{g_\infty}, K_{\nu_D}(\alpha) d_{g_\infty})$$

holds in the sense of the Gromov-Hausdorff distance.

It would suffice to establish the following convergence in distribution

$$\left(t^{-\beta^*/\alpha} H_{S_\alpha(t)}(1, e^{2i\pi r})\right)_{r \in [0, 1]} \xrightarrow[t \rightarrow \infty]{(d)} \left(K_{\nu_D}(\alpha) \mathcal{M}_\infty(e^{2i\pi r})\right)_{r \in [0, 1]}$$

in the Skorokhod sense (the mapping  $r \mapsto H_{S_\alpha(t)}(1, e^{2i\pi r})$  is not defined when  $e^{2i\pi r}$  is a foot of  $S_\alpha(t)$ , but we can choose a suitable convention so that this mapping is defined and càdlàg over  $[0, 1]$ ). Proving that this convergence holds would require more information about the process  $(H_{S_\alpha(t)}(1, x))_{x \in \mathbb{S}_1, t \geq 0}$ .

## 7.5 Identifying the limiting lamination

### 7.5.1 Preliminaries

The next proposition is the first step towards the proof of Theorem 7.2. We recall the notation introduced at the beginning of subsection 7.3.3 :  $a = e^{2i\pi U_1}$  and  $b = e^{2i\pi U_2}$  are the feet of the first chord, with  $0 < U_1 < U_2 < 1$ , and  $M = 1 - (U_2 - U_1)$ .

**Proposition 7.29.** *Conditionally on the pair  $(U_1, U_2)$ , we have*

$$\left(\mathcal{M}_\infty(e^{2i\pi(U_1+(U_2-U_1)r)}) - \mathcal{M}_\infty(e^{2i\pi U_1})\right)_{r \in [0, 1]} \stackrel{(d)}{=} \left((1 - M)^{\beta^*} \tilde{\mathcal{M}}_\infty(e^{2i\pi r})\right)_{r \in [0, 1]}$$

where  $\tilde{\mathcal{M}}_\infty$  is copy of  $\mathcal{M}_\infty$  independent of  $M$ . Moreover, we have

$$\mathcal{M}_\infty(e^{2i\pi U_1}) > 0, \quad a.s.$$

*Démonstration.* This is essentially a consequence of Lemma 7.19. Fix  $\alpha > 0$  and  $r \in ]0, 1[$ . Using the notation introduced before this lemma, we have on the event  $\{U_1 < r < U_2\}$ , for every  $t \geq 0$ ,

$$H_{S_\alpha(\tau+t)}(1, e^{2i\pi r}) = 1 + H_{S_\alpha^{(R')}(\tau+t)}(1, e^{2i\pi U_1}) + H_{S_\alpha^{(R'')}(\tau+t)}(e^{2i\pi U_1}, e^{2i\pi r}).$$

From Lemma 7.19, we now get on the event  $\{U_1 < r < U_2\}$  that conditionally on  $(U_1, U_2)$ ,

$$\left( H_{S_\alpha(\tau+t)}(1, e^{2i\pi r}) \right)_{t \geq 0} \stackrel{(d)}{=} \left( 1 + H_{S'_\alpha(M^\alpha t)}(1, \Psi_{a,b}(a)) + H_{S''_\alpha((1-M)^\alpha t)}(1, \Phi_{a,b}(e^{2i\pi r})) \right)_{t \geq 0}.$$

We multiply each side by  $t^{-\beta^*/\alpha}$  and pass to the limit  $t \rightarrow \infty$ , using Theorem 7.25 (iii), and we get with an obvious notation that, on the event  $\{U_1 < r < U_2\}$  and conditionally on  $(U_1, U_2)$ ,

$$\mathcal{M}_\infty(e^{2i\pi r}) \stackrel{(d)}{=} M^{\beta^*} \mathcal{M}'_\infty(\Psi_{a,b}(a)) + (1-M)^{\beta^*} \mathcal{M}''_\infty(e^{2i\pi\phi_{U_1, U_2}(r)}).$$

This identity in distribution is immediately extended to a finite number of values of  $r$  by the same argument. Noting that  $\phi_{U_1, U_2}(U_1 + (U_2 - U_1)r) = r$ , we thus get that, conditionally on  $(U_1, U_2)$ ,

$$\left( \mathcal{M}_\infty(e^{2i\pi(U_1 + (U_2 - U_1)r)}) \right)_{r \in [0,1]} \stackrel{(d)}{=} \left( M^{\beta^*} \mathcal{M}'_\infty(\Psi_{a,b}(a)) + (1-M)^{\beta^*} \mathcal{M}''_\infty(e^{2i\pi r}) \right)_{r \in [0,1]}.$$

In particular  $\mathcal{M}_\infty(e^{2i\pi U_1}) \stackrel{(d)}{=} M^{\beta^*} \mathcal{M}'_\infty(\Psi_{a,b}(a)) > 0$  a.s. by Theorem 7.25 (ii), and the identity in distribution of the proposition also follows from the previous display.  $\square$

Recall the notation  $S(\infty)$ ,  $S^*(\infty)$  from the end of Section 2.

**Lemma 7.30.** *For every  $x \in \mathbb{S}_1$ ,  $\mathbb{P}[\exists y \in \mathbb{S}_1 \setminus \{x\} : (x, y) \in S^*(\infty)] = 0$ .*

*Démonstration.* Let  $\varepsilon > 0$ . It is enough to prove that, for every  $x \in \mathbb{S}_1$ ,

$$\mathbb{P}[\exists y \in \mathbb{S}_1 : |y - x| > \varepsilon \text{ and } (x, y) \in S^*(\infty)] = 0.$$

Thanks to rotational invariance, this will follow if we can verify that

$$\mathbb{E} \left[ \int \mathfrak{m}(dx) \mathbf{1}_{\{\exists y \in \mathbb{S}_1 : |y-x| > \varepsilon \text{ and } (x,y) \in S^*(\infty)\}} \right] = 0.$$

Note that if  $(x, y) \in S^*(\infty)$  the chord  $[xy]$  does not cross any of the (other) chords of  $S(\infty)$ .

We can find an integer  $n$  (depending on  $\varepsilon$ ) and  $n$  points  $z_1, \dots, z_n$  of  $\mathbb{S}_1$  such that the following holds. Whenever  $x, y \in \mathbb{S}_1$  are such that  $|y - x| > \varepsilon$ , there exists an index  $j \in \{1, \dots, n\}$  such that  $z_j$  belongs to one of the two open subarcs with endpoints  $x$  and  $y$ , and  $-z_j$  belongs to the other subarc. If we assume also that  $(x, y) \in S^*(\infty)$ , it follows that  $x$  belongs to the boundary of a fragment of  $S_0(t)$  separating  $z_j$  from  $-z_j$ , for every  $t \geq 0$ .

Thanks to these observations, we have for every  $t \geq 0$ ,

$$\int \mathfrak{m}(dx) \mathbf{1}_{\{\exists y \in \mathbb{S}_1 : |y-x| > \varepsilon \text{ and } (x,y) \in S^*(\infty)\}} \leq \sum_{j=1}^n \left( \sum_i \mathfrak{m}(R_i^{z_j, -z_j}(S_0(t))) \right)$$

with the notation introduced in Definition 7.20. From Theorem 7.25 (iv) and the fact that  $\kappa_{\nu_D}(1) > 0$ , the right-hand side tends to 0 almost surely as  $t \rightarrow \infty$ , which completes the proof.  $\square$

Recall our notation  $g_\infty(r) = \mathcal{M}_\infty(e^{2i\pi r})$  for every  $r \in [0, 1]$ . Notice that  $g = g_\infty$  satisfies the assumptions of subsection 7.2.3.

**Corollary 7.31.** *Almost surely, for every  $r, s \in [0, 1]$  such that  $\{e^{2i\pi r}, e^{2i\pi s}\} \in S(\infty)$ , we have  $r \stackrel{g_\infty}{\approx} s$ .*

*Démonstration.* If  $c, d$  are two distinct points of  $\mathbb{S}_1 \setminus \{1\}$ , write  $\text{Arc}^*(c, d)$  for the open subarc of  $\mathbb{S}_1$  with endpoints  $c$  and  $d$  not containing 1. As an immediate consequence of Proposition 7.29, we have  $\mathcal{M}_\infty(x) \geq \mathcal{M}_\infty(a) = \mathcal{M}_\infty(b) > 0$ , for every  $x \in \text{Arc}^*(a, b)$ . This property is easily extended by induction (using Lemma 7.19 once again) to any chord appearing in the figela process. We have almost surely for every  $\{c, d\} \in S(\infty)$ ,

$$\mathcal{M}_\infty(x) \geq \mathcal{M}_\infty(c) = \mathcal{M}_\infty(d) > 0, \quad \text{for every } x \in \text{Arc}^*(c, d). \quad (7.23)$$

We can in fact replace the weak inequality  $\mathcal{M}_\infty(x) \geq \mathcal{M}_\infty(c)$  by a strict one. To see this, we first note that, by Lemma 7.30, 1 is not an endpoint of a (non-degenerate) chord of  $S^*(\infty)$ . By an easy argument, this implies that almost surely, for every  $\varepsilon > 0$ , there exist  $r \in ]-\varepsilon, 0[$  and  $s \in ]0, \varepsilon[$  such that the chord  $[e^{2i\pi r}, e^{2i\pi s}]$  belongs to  $S(\infty)$ . It follows that

$$\bigcup_{\{c,d\} \in S(\infty)} \text{Arc}^*(c, d) = \mathbb{S}_1 \setminus \{1\}, \quad \text{a.s.}$$

From (7.23) we now get that  $\mathcal{M}_\infty(x) > 0$ , for every  $x \in \mathbb{S}_1 \setminus \{1\}$ , a.s.

We can apply this property to the process  $\tilde{\mathcal{M}}_\infty$  in Proposition 7.29, and we get that  $\mathcal{M}_\infty(x) > \mathcal{M}_\infty(a) = \mathcal{M}_\infty(b)$ , for every  $x \in \text{Arc}^*(a, b)$ , a.s. Again, this property of the first chord is easily extended by induction to any chord in the figela process, and we obtain that, almost surely for every  $\{c, d\} \in S(\infty)$ ,

$$\mathcal{M}_\infty(x) > \mathcal{M}_\infty(c) = \mathcal{M}_\infty(d), \quad \text{for every } x \in \text{Arc}^*(c, d). \quad (7.24)$$

The statement of Corollary 7.31 now follows from the definition of  $\stackrel{g_\infty}{\approx}$ . □

If  $(x, y) \in S^*(\infty)$  we can write  $(x, y) = \lim(x_n, y_n)$  where  $\{x_n, y_n\} \in S(\infty)$  for every  $n$ . Write  $x = e^{2i\pi r}$ ,  $y = e^{2i\pi s}$  and  $x_n = e^{2i\pi r_n}$ ,  $y_n = e^{2i\pi s_n}$ , where  $r, s, r_n, s_n \in [0, 1]$ . By Corollary 7.31, we have  $r_n \stackrel{g_\infty}{\approx} s_n$  for every  $n$ . Since the graph of the relation  $\stackrel{g_\infty}{\approx}$  is closed, it follows that  $r \stackrel{g_\infty}{\approx} s$ . We have thus proved that

$$L_\infty \subset L_{g_\infty}.$$

The reverse inclusion will be proved in the next subsection.

### 7.5.2 Maximality of the limiting lamination

The proof of Theorem 7.2 will be completed thanks to the following proposition.

**Proposition 7.32.** *Almost surely,  $L_\infty$  is a maximal lamination of  $\bar{\mathbb{D}}$ .*

Before proving Proposition 7.32, we need to establish a preliminary lemma. This lemma is concerned with the genealogical tree of fragments appearing in the figela process, which we construct as follows. We consider the fragments created by  $S_0(t)$  as time increases. The first fragment is  $R_\emptyset = \mathbb{D}$ . At the exponential time  $\tau$ , the first chord splits  $\mathbb{D}$  into two fragments, which are viewed as the offspring of  $\emptyset$ . We then order these fragments in a random way : with probability 1/2, we call  $R_0$  the fragment with the largest mass and  $R_1$  the other one, and with probability 1/2 we do the contrary. We then iterate this device. Then each fragment that appears in the figela process is labeled by an element of the infinite binary tree

$$\mathbb{T} = \bigcup_{n \geq 0} \{0, 1\}^n.$$

For every integer  $n$ , we also set

$$\mathbb{T}_n := \bigcup_{k=0}^n \{0, 1\}^k.$$

At every time  $t$ , we have a (finite) binary tree corresponding to the genealogy of the fragments present at time  $t$ . See Fig.5 below.

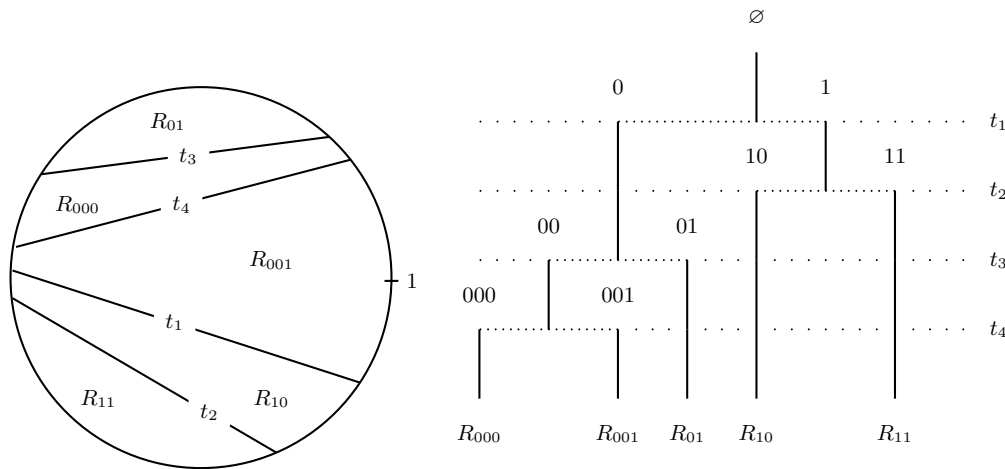

FIGURE 7.5 – Chords are represented on the left side with their respective creation times. On the right side the genealogical tree of the fragments  $R_{000}, \dots, R_{11}$  present at time  $t_4$ .

If  $R$  is a fragment, we call *end* of  $R$  any connected component of  $R \cap \mathbb{S}_1$ . We denote the number of ends of a fragment  $R$  by  $e(R)$ . For reasons that will be explained later, the full disk  $\mathbb{D}$  is viewed as a fragment with 0 end.

**Lemma 7.33.** *In the (infinite) genealogical tree of fragments, almost surely, there is no ray along which all fragments have eventually strictly more than 3 ends.*



*Proof of Lemma 7.33.* Let  $n \geq 0$  and  $u \in \{0, 1\}^n$ , and consider the fragment  $R_u$ . Let  $y_u$  be one endpoint (chosen at random) of the first chord that will fall inside  $R_u$ . Note that, conditionally on  $R_u$ ,  $y_u$  is uniformly distributed over  $R_u \cap \mathbb{S}_1$ . Let  $\varphi_u : [0, m(R_u)[ \rightarrow \overline{R_u} \cap \overline{\mathbb{S}_1}$  be defined by requiring that the measure of the intersection of  $R_u \cap \mathbb{S}_1$  with the arc (in counterclockwise order) between  $y_u$  and  $\varphi_u(t)$  is equal to  $t$ , for every  $t \in [0, m(R_u)[$ . This definition is unambiguous if we also impose that  $\varphi_u$  is right-continuous. Then  $\varphi_u$  has exactly  $e(R_u)$  discontinuity times corresponding to the chords that lie in the boundary of  $R_u$  (indeed the left and right limits of  $\varphi_u$  at a discontinuity time are the endpoints of a chord adjacent to  $R_u$ ). We claim that, conditionally given  $(m(R_u), e(R_u))$ , the set of discontinuity times of  $\varphi_u$  is distributed as the collection of  $e(R_u)$  independent points chosen uniformly over  $[0, m(R_u)[$ .

This claim can be checked by induction on  $n$ . For  $n = 0$  there is nothing to prove. Assume that the claim holds up to order  $n$ . Recalling that  $y_u$  is one endpoint of the first chord that will fall in  $R_u$ , the other endpoint  $z_u$  will be chosen uniformly over  $R_u \cap \mathbb{S}_1$ , so that  $\varphi_u^{-1}(z_u)$  will be uniform over  $[0, m(R_u)[$ . We have then  $e(R_{u0}) = K + 1$  and  $e(R_{u1}) = e(R_u) + 1 - K$  (or the contrary with probability  $1/2$ ), where  $K$  is the number of discontinuity times of  $\varphi_u$  in  $[0, \varphi_u^{-1}(z_u)[$ . Using our induction hypothesis, we see that conditionally on  $K$  and on  $\varphi_u^{-1}(z_u)$  the latter discontinuity times are independent and uniformly distributed over  $[0, \varphi_u^{-1}(z_u)[$ , and that a similar property holds for the discontinuity times that belong to  $[\varphi_u^{-1}(z_u), m(R_u)[$ . It follows that the desired property will still hold at order  $n + 1$ .

The preceding arguments also show that, conditionally on  $R_u$ ,  $e(R_{u0})$  is distributed as  $K + 1$ , where  $K$  is obtained by throwing  $e(R_u) + 1$  uniform random variables in  $[0, m(R_u)[$  and counting how many among the  $e(R_u)$  first ones are smaller than the last one. By an obvious symmetry argument, we have, for any integers  $p \geq 0$ ,  $k \in \{0, \dots, p\}$  and any  $a \in ]0, 1]$ ,

$$\mathbb{P}[e(R_{u0}) = k + 1 \mid e(R_u) = p, m(R_u) = a] = \frac{1}{p + 1}.$$

Notice that the preceding conditional probability does not depend on  $a$ , which could have been seen from a scaling argument.

Modulo some technical details that are left to the reader, we get that the distribution of the tree-indexed process  $(e(R_u), u \in \mathbb{T})$  can be described as follows. We start with  $e(\emptyset) = 0$  and we then proceed by induction on  $n$  to define  $e(R_u)$  for every  $u \in \{0, 1\}^n$ . To this end, given the values of  $e(R_u)$  for  $u \in \mathbb{T}_n$ , we choose independently for every  $v \in \{0, 1\}^n$  a random variable  $k_v$  uniform over  $\{0, \dots, e(R_v)\}$  and we set  $e(R_{v0}) = k_v + 1$ ,  $e(R_{v1}) = e(R_v) - k_v + 1$ .

Consider a tree-indexed process  $(f_u, u \in \mathbb{T})$  that evolves according to the preceding rules but starts with  $f_\emptyset = 4$  (instead of  $e(R_\emptyset) = 0$ ). In order to get the statement of the lemma, it is enough to prove that almost surely, there is no infinite ray starting from the root along which all the values of  $f_u$  are strictly larger than 3. Consider a fixed infinite ray in the tree, say  $\emptyset, 0, 00, 000, \dots$  and let  $X_0 = f_\emptyset$ ,  $X_1 = f_0$ ,  $X_2 = f_{00}, \dots$  be the values of our process along the ray. Note that  $(X_n)_{n \geq 0}$  is a Markov chain with

values in  $\mathbb{N}$ , with transition kernel given by

$$q_{k\ell} = \frac{1}{k+1} \mathbf{1}_{\{1 \leq \ell \leq k+1\}},$$

for every  $k, \ell \geq 1$ . Write  $(\mathcal{F}_n)_{n \geq 0}$  for the filtration generated by the process  $(X_n)_{n \geq 0}$ . We have

$$\mathbb{E}[X_{n+1} | \mathcal{F}_n] = \frac{1}{X_n + 1} (1 + 2 + \dots + (X_n + 1)) = \frac{X_n}{2} + 1.$$

Hence  $M_n = 2^n(X_n - 2)$  is a martingale starting from 2. For  $i \geq 1$  we let  $T_i$  be the stopping time  $T_i = \inf\{n \geq 0 : X_n = i\}$ , and  $T = T_1 \wedge T_2 \wedge T_3$ .

Note that  $\mathbb{P}[X_k \geq 4, \text{ for every } 0 \leq k \leq n] = \mathbb{P}[T > n]$ , and that the preceding discussion applies to the values of  $f_u$  along any infinite ray starting from the root.

By the stopping theorem applied to the martingale  $(M_n)_{n \geq 0}$ , we obtain for every  $n \geq 0$ ,

$$2 = \mathbb{E}[M_{n \wedge T}] = \mathbb{E}[-2^{T_1} \mathbf{1}_{\{T_1 = T \leq n\}}] + 0 + \mathbb{E}[2^{T_3} \mathbf{1}_{\{T_3 = T \leq n\}}] + \mathbb{E}[2^n(X_n - 2) \mathbf{1}_{\{T > n\}}].$$

From the transition kernel of the Markov chain  $(X_n)_{n \geq 0}$  it is easy to check that for every  $k \geq 1$ ,  $\mathbb{P}[T_1 = T = k] = \mathbb{P}[T_2 = T = k] = \mathbb{P}[T_3 = T = k]$ . Hence, the equality in the last display becomes

$$2 = \mathbb{E}[2^n(X_n - 2) \mathbf{1}_{\{T > n\}}],$$

or equivalently

$$2 = 2^n \mathbb{P}[T > n] \mathbb{E}[X_n - 2 | T > n].$$

Since obviously  $\mathbb{E}[X_n - 2 | T > n] \geq 2$ , we get  $2^n \mathbb{P}[T > n] \leq 1$ .

For every  $u = (u_1, \dots, u_n) \in \{0, 1\}^n$ , and every  $j \in \{0, 1, \dots, n\}$ , set  $[u]_j = (u_1, \dots, u_j)$ , and if  $j \geq 1$ , also set  $[u]_j^* = (u_1, \dots, u_{j-1}, 1 - u_j)$ . Let

$$G_n = \{u \in \{0, 1\}^n : f_{[u]_j} \geq 4, \forall j \in \{0, 1, \dots, n\}\}.$$

Clearly

$$\mathbb{E}[\#G_n] = 2^n \mathbb{P}[T > n] \leq 1. \tag{7.25}$$

In order to get the statement of the lemma, it is enough to verify that  $\mathbb{P}[\#G_n \geq 1] \rightarrow 0$  as  $n \rightarrow \infty$ . Note that the sequence  $\mathbb{P}[\#G_n \geq 1]$  is monotone non-increasing. We argue by contradiction and assume that there exists  $\eta > 0$  such that  $\mathbb{P}[\#G_n \geq 1] \geq \eta$  for every  $n \geq 1$ . By a simple coupling argument, the same lower bound will remain valid if we start the tree-indexed process with  $f_\emptyset = m$ , for any  $m \geq 4$ , instead of  $f_\emptyset = 4$ .

Fix  $\varepsilon \in ]0, \eta[$ , and choose an integer  $\ell \geq 1$  such that  $1/\ell \leq \varepsilon/2$ . Choose another integer  $k \geq 1$  such that, if  $B_{k,\eta}$  denotes a binomial  $\mathcal{B}(k, \eta)$  random variable, we have  $\mathbb{P}[B_{k,\eta} \leq \ell] \leq \varepsilon/2$ . Finally set

$$\begin{aligned} G'_n &= \{u \in G_n : \#\{j \in \{0, 1, \dots, n-1\} : f_{[u]_{j+1}} \leq f_{[u]_j} - 2\} \leq k\}, \\ G''_n &= G_n \setminus G'_n. \end{aligned}$$

We first evaluate  $\mathbb{P}[G''_n \neq \emptyset]$ . We have

$$\mathbb{P}[G''_n \neq \emptyset] \leq \mathbb{P}[G''_n \neq \emptyset, \#G_n \leq \ell] + \mathbb{P}[\#G_n > \ell].$$

By (7.25) and our choice of  $\ell$ , we have  $\mathbb{P}[\#G_n > \ell] \leq \ell^{-1} \mathbb{E}[\#G_n] \leq \varepsilon/2$ . On the other hand,

$$\begin{aligned} \mathbb{P}[G_n'' \neq \emptyset, \#G_n \leq \ell] &\leq \mathbb{E}[\#G_n'' \mathbf{1}_{\{\#G_n \leq \ell\}}] \\ &= \sum_{u \in \{0,1\}^n} \mathbb{P}[u \in G_n'', \#G_n \leq \ell] \\ &= \sum_{u \in \{0,1\}^n} \mathbb{P}[u \in G_n''] \mathbb{P}[\#G_n \leq \ell \mid u \in G_n''] \end{aligned}$$

Fix  $u \in \{0,1\}^n$ . We argue conditionally on the values of  $f_{[u]_j}$  for  $0 \leq j \leq n$ , and note that the values of  $f_{[u]_{j+1}^*}$  for  $0 \leq j \leq n-1$  are then also determined by the condition  $f_{[u]_{j+1}} + f_{[u]_{j+1}^*} = f_{[u]_j} + 2$ . Moreover, on the event  $\{u \in G_n''\}$ , there are at least  $k$  values of  $j \in \{0, 1, \dots, n-1\}$  such that  $f_{[u]_{j+1}} \leq f_{[u]_j} - 2$ . For these values of  $j$ , we must have  $f_{[u]_{j+1}^*} \geq 4$ . Furthermore, for each such value of  $j$ , there is (conditional) probability at least  $\eta$  that one of the descendants of  $[u]_{j+1}^*$  at generation  $n$ , say  $v$ , is such that  $f_{[v]_i} \geq 4$  for every  $i \in \{j+1, \dots, n\}$ , and consequently  $v \in G_n$ . Summarizing, we see that conditionally on the event  $\{u \in G_n''\}$ ,  $\#G_n$  is bounded below in distribution by a binomial  $\mathcal{B}(k, \eta)$  random variable. Hence, using our choice of  $k$ ,

$$\mathbb{P}[\#G_n \leq \ell \mid u \in G_n''] \leq \mathbb{P}[B_{k,\eta} \leq \ell] \leq \frac{\varepsilon}{2}.$$

We thus get

$$\mathbb{P}[G_n'' \neq \emptyset, \#G_n \leq \ell] \leq \frac{\varepsilon}{2} \sum_{u \in \{0,1\}^n} \mathbb{P}[u \in G_n''] = \frac{\varepsilon}{2} \mathbb{E}[\#G_n''] \leq \frac{\varepsilon}{2},$$

by (7.25). It follows that

$$\limsup_{n \rightarrow \infty} \mathbb{P}[G_n'' \neq \emptyset] \leq \varepsilon.$$

We will now verify that  $\mathbb{P}[G_n' \neq \emptyset]$  tends to 0 as  $n \rightarrow \infty$ . Since  $\varepsilon < \eta$ , this will give a contradiction with our assumption  $\mathbb{P}[\#G_n \geq 1] \geq \eta$  for every  $n \geq 1$ , thus completing the proof. We in fact show that  $\mathbb{E}[\#G_n']$  tends to 0 as  $n \rightarrow \infty$ . To this end, we first write, for  $n \geq k$ ,

$$\begin{aligned} \mathbb{E}[\#G_n'] &= 2^n \mathbb{P}[T > n, \#\{j \in \{0, \dots, n-1\} : X_{j+1} \leq X_j - 2\} \leq k] \\ &\leq 2^n n^k \sup_{A \subset \{0,1,\dots,n-1\}, \#A=k} \mathbb{P}[X_{j+1} \geq (X_j - 1) \vee 4, \forall j \in \{0, 1, \dots, n-1\} \setminus A] \end{aligned} \tag{7.26}$$

We thus need to bound the quantity

$$\mathbb{P}[X_{j+1} \geq (X_j - 1) \vee 4, \forall j \in \{0, 1, \dots, n-1\} \setminus A],$$

for every choice of  $A \subset \{0, 1, \dots, n-1\}$  such that  $\#A = k$ . For every subset  $A$  of  $\{0, 1, \dots, n-1\}$ , we set

$$N_n^A = \#\{j \in \{0, 1, \dots, n-1\} \setminus A : X_j = 5\}.$$

With a slight abuse of notation, write  $\mathbb{P}_i$  for a probability measure under which the Markov chain  $X$  starts from  $i$ . We prove by induction on  $n$  that for every choice of  $A \subset \{0, 1, \dots, n-1\}$  and  $m \in \{0, 1, \dots, n - \#A\}$ , we have for every  $i \geq 1$ ,

$$\mathbb{P}_i \left[ X_{j+1} \geq (X_j - 1) \vee 4, \forall j \in \{0, 1, \dots, n-1\} \setminus A; N_n^A = m \right] \leq \left(\frac{1}{2}\right)^m \left(\frac{3}{7}\right)^{n-m-\#A}. \quad (7.27)$$

If  $n = 0$  (then necessarily  $m = 0$  and  $A = \emptyset$ ) there is nothing to prove. Assume that the desired bound holds at order  $n-1$ . In order to prove that it holds at order  $n$ , we apply the Markov property at time 1. We need to distinguish three cases.

If  $0 \in A$ , then the left-hand side of (7.27) is equal to

$$\sum_{i'} q_{ii'} \mathbb{P}_{i'} \left[ X_{j+1} \geq (X_j - 1) \vee 4, \forall j \in \{0, 1, \dots, n-2\} \setminus A'; N_{n-1}^{A'} = m \right],$$

where  $A' = \{j-1 : j \in A, j > 0\}$ . Since  $\#A' = \#A - 1$  in that case, an application of the induction hypothesis gives the result.

If  $0 \notin A$  and  $i \neq 5$ , then the left-hand side of (7.27) is equal to

$$\begin{aligned} & \sum_{i' \geq (i-1) \vee 4} q_{ii'} \mathbb{P}_{i'} \left[ X_{j+1} \geq (X_j - 1) \vee 4, \forall j \in \{0, 1, \dots, n-2\} \setminus A'; N_{n-1}^{A'} = m \right] \\ & \leq \sum_{i' \geq (i-1) \vee 4} q_{ii'} \left(\frac{1}{2}\right)^m \left(\frac{3}{7}\right)^{n-1-m-\#A'}, \end{aligned}$$

and we just have to observe that

$$\sum_{i' \geq (i-1) \vee 4} q_{ii'} \leq \frac{3}{7}$$

when  $i \neq 5$ .

Finally, if  $0 \notin A$  and  $i = 5$ , the left-hand side of (7.27) is equal to

$$\begin{aligned} & \sum_{i' \geq 4} q_{5i'} \mathbb{P}_{i'} \left[ X_{j+1} \geq (X_j - 1) \vee 4, \forall j \in \{0, 1, \dots, n-2\} \setminus A'; N_{n-1}^{A'} = m-1 \right] \\ & \leq \left( \sum_{i' \geq 4} q_{5i'} \right) \left(\frac{1}{2}\right)^{m-1} \left(\frac{3}{7}\right)^{(n-1)-(m-1)-\#A'} \\ & = \left(\frac{1}{2}\right)^m \left(\frac{3}{7}\right)^{n-m-\#A}, \end{aligned}$$

using the fact that  $\sum_{i' \geq 4} q_{5i'} = 1/2$ . This completes the proof of (7.27).

Fix  $\delta \in ]0, 1[$ . By summing over possible values of  $m$ , we get for  $n$  large, for all choices of  $A \subset \{0, 1, \dots, n-1\}$  such that  $\#A = k$

$$\begin{aligned} & \mathbb{P} \left[ X_{j+1} \geq (X_j - 1) \vee 4, \forall j \in \{0, 1, \dots, n-1\} \setminus A \right] \\ & \leq \sum_{m=0}^{n-\lfloor \delta n \rfloor} \left(\frac{1}{2}\right)^m \left(\frac{3}{7}\right)^{n-m-k} + \mathbb{P} \left[ N_n^A > n - \lfloor \delta n \rfloor \right] \\ & \leq n \left(\frac{1}{2}\right)^{n-\lfloor \delta n \rfloor} \left(\frac{3}{7}\right)^{\lfloor \delta n \rfloor - k} + \mathbb{P} \left[ N_n^A > n - \lfloor \delta n \rfloor \right]. \end{aligned}$$

Note that  $N_n^A \leq N_n^\emptyset$ . Crude estimates, using the fact that  $\sup_{i \geq 1} q_{i5} = 1/5$ , show that we can fix  $\delta$  such that

$$2^n n^{k+1} \mathbb{P} [N_n^\emptyset > n - \lfloor \delta n \rfloor] \xrightarrow{n \rightarrow \infty} 0.$$

It then follows that the right-hand side of (7.26) tends to 0 as  $n \rightarrow \infty$ , which completes the proof.  $\square$

**Remark 7.34.** For every integer  $k \geq 1$ , let  $(f_u^{(k)}, u \in \mathbb{T})$  be a tree-indexed process that evolves according to the same rules as  $(f_u, u \in \mathbb{T})$  but starts with  $f_\emptyset^{(k)} = k$ . Let  $p_k$  be the probability that there exists no infinite ray starting from  $\emptyset$  along which all labels  $f_u^{(k)}$  are strictly greater than 3. By conditioning on the values of  $f_0^{(k)}$  and  $f_1^{(k)}$ , we see that  $(p_k)_{k \geq 1}$  satisfies the properties

$$\begin{cases} p_1 = p_2 = p_3 = 1, \\ p_k = \frac{1}{k+1} (p_1 p_{k+1} + p_2 p_k + \dots + p_k p_2 + p_{k+1} p_1), \quad \text{if } k \geq 4. \end{cases} \quad (7.28)$$

It follows that the values of  $p_k$  for  $k \geq 5$  are determined recursively from the value of  $p_4$ . Numerical simulations suggest that there exists no sequence  $(p_k)_{k \geq 1}$  satisfying (7.28) such that  $p_4 < 1$  and  $0 \leq p_k \leq 1$  for every  $k \geq 1$ . A rigorous verification of this fact would provide an alternative more analytic proof of Lemma 7.33.

*Proof of Proposition 7.32.* First note that it is easy to verify that  $L_\infty \cap \mathbb{S}_1$  is dense in  $\mathbb{S}_1$  and thus  $\mathbb{S}_1 \subset L_\infty$  since  $L_\infty$  is closed. We argue by contradiction and suppose that  $L_\infty$  is not a maximal lamination. Then there exists a (non-degenerate) chord  $[xy]$  which is not contained in  $L_\infty$  and is such that  $L_\infty \cup [xy]$  is still a lamination, which implies that  $]xy[$  does not intersect any chord of  $S(\infty)$ . There is a unique infinite ray  $\emptyset, \epsilon_1, \epsilon_1 \epsilon_2, \dots$  in  $\mathbb{T}$  such that  $]xy[ \subset R_{\epsilon_1 \dots \epsilon_n}$  for every integer  $n \geq 0$ . We claim that for all  $n$  sufficiently large  $R_{\epsilon_1 \dots \epsilon_n}$  has at least 4 ends. To see this, denote by  $I_n^x$  the end of  $R_{\epsilon_1 \dots \epsilon_n}$  whose closure  $\bar{I}_n^x$  contains  $x$ , and define  $I_n^y$  similarly. Note that the maximal length of an end of a fragment at the  $n$ -th generation tends to 0 a.s., and that this applies in particular to  $I_n^x$  and  $I_n^y$ . It follows that, almost surely for all  $n$  sufficiently large, there is no chord of  $S(\infty)$  between a point of  $\bar{I}_n^x$  and a point of  $\bar{I}_n^y$  (otherwise, the pair  $(x, y)$  would be in  $S^*(\infty)$  and the chord  $[xy]$  would be contained in  $L_\infty$ ). Hence, for all  $n$  sufficiently large, the boundary of  $R_{\epsilon_1 \dots \epsilon_n}$  contains at least 4 different chords, and therefore at least 4 ends. This contradicts Lemma 7.33, and this contradiction completes the proof.  $\square$

*Proof of Theorem 7.2.* Since  $L_\infty$  is a maximal lamination and  $L_\infty \subset L_{g_\infty}$ , we must have  $L_\infty = L_{g_\infty}$  and in particular  $L_{g_\infty}$  is a maximal lamination. Thus, the function  $g_\infty$  must satisfy the necessary and sufficient condition for maximality given in Proposition 7.9. Under this condition however, the relations  $\overset{g_\infty}{\approx}$  and  $\overset{g_\infty}{\sim}$  coincide. Recalling that  $\mathcal{M}_\infty(x) > 0 = \mathcal{M}_\infty(1)$  for every  $x \in \mathbb{S}_1 \setminus \{1\}$ , we see that property (7.1) written with  $x = e^{2i\pi r}$  and  $y = e^{2i\pi s}$  is equivalent to saying that  $r \overset{g_\infty}{\sim} s$ . Theorem 7.2 then follows from the fact that  $L_\infty = L_{g_\infty}$ .  $\square$

**Remark 7.35.** It is not hard to see that  $L_\infty$  has zero Lebesgue measure a.s. (this follows from the upper bound on the Hausdorff dimension proved in the next section). By a simple argument, it follows that a chord  $[xy]$  is contained in  $L_\infty$  if and only if  $x \stackrel{g_\infty}{\approx} y$ , and this condition is also equivalent to  $(x, y) \in S^*(\infty)$ .

## 7.6 The Hausdorff dimension of $L_\infty$

In this section, we prove Theorem 7.3. We let  $\mathcal{I}$  be the countable set of all pairs  $(I, J)$  where  $I$  and  $J$  are two disjoint closed subarcs of  $\mathbb{S}_1$  with nonempty interior and endpoints of the form  $\exp(2i\pi r)$  with rational  $r$ . For each  $(I, J) \in \mathcal{I}$ , we set

$$L_{(I,J)} = \bigcup_{(y,z) \in S^*(\infty) \cap (I \times J)} [yz] \subset L_\infty.$$

Clearly,

$$\dim L_\infty = \sup_{(I,J) \in \mathcal{I}} \dim(L_{(I,J)}). \tag{7.29}$$

*Upper bound.* We prove that, for every  $(I, J) \in \mathcal{I}$ ,

$$\dim(L_{(I,J)}) \leq \frac{\sqrt{17} - 1}{2} = \beta^* + 1, \quad \text{a.s.}$$

By rotational invariance, we may assume without loss of generality that  $1 \notin I \cup J$ . We pick a point  $x \in \mathbb{S}_1 \setminus (I \cup J)$  such that 1 and  $x$  belong to different components of  $\mathbb{S}_1 \setminus (I \cup J)$ . We also fix  $\gamma > \beta^* + 1$  and set  $\beta = \gamma - 1 > \beta^*$ .

We consider the figela process  $(S_0(t), t \geq 0)$  with autosimilarity parameter  $\alpha = 0$ . We fix  $t > 0$  for the moment and denote the maximal number of ends in a fragment of  $S_0(t)$  by  $E(t)$ .

Recall that  $R_i^{(1,x)}(S_0(t))$ ,  $1 \leq i \leq H_{S_0(t)}(1, x) + 1$  are the fragments of  $S_0(t)$  separating 1 from  $x$ . Any chord  $[yz]$  with  $(y, z) \in S^*(\infty) \cap (I \times J)$  must be contained in the closure of one of these fragments (otherwise this chord would cross one of the chords of  $S_0(t)$ , which is impossible). Consequently, the sets

$$\overline{(I \cap R_i^{(1,x)}(S_0(t)))} \times \overline{(J \cap R_i^{(1,x)}(S_0(t)))}, \quad 1 \leq i \leq H_{S_0(t)}(1, x) + 1$$

form a covering of  $S^*(\infty) \cap (I \times J)$ . We get a finer covering by considering the sets  $\overline{C} \times \overline{D}$ , where  $C$  varies over the connected components of  $I \cap R_i^{(1,x)}(S_0(t))$  and  $D$  varies over the connected components of  $J \cap R_i^{(1,x)}(S_0(t))$ . We denote these connected components by  $C_{ik}$ ,  $1 \leq k \leq k_i$  and  $D_{i\ell}$ ,  $1 \leq \ell \leq \ell_i$  respectively. Note that  $k_i + \ell_i \leq 2e(R_i^{(1,x)}(S_0(t))) \leq 2E(t)$ . Summarizing the preceding discussion, we have

$$L_{(I,J)} \subset \left( \bigcup_{i=1}^{H_{S_0(t)}(1,x)+1} \bigcup_{k=1}^{k_i} \bigcup_{\ell=1}^{\ell_i} C_{k,\ell}^i \right) \tag{7.30}$$

where  $C_{k,\ell}^i$  stands for the union of all chords  $[yz]$  for  $y \in \overline{C}_{ik}$  and  $z \in \overline{D}_{i\ell}$ .

For every  $1 \leq i \leq H_{S_0(t)}(1, x) + 1$ , let

$$\eta_i(t) = 2\pi \, m(R_i^{(1,x)}(S_0(t)))$$

be the length of  $R_i^{(1,x)}(S_0(t)) \cap \mathbb{S}_1$ . Obviously the length of any of the arcs  $C_{ik}, D_{il}$  is bounded above by  $\eta_i(t)$ . Consequently, we can cover each set  $C_{k,\ell}^i$  by at most  $10 \eta_i(t)^{-1}$  disks of diameter  $2\eta_i(t)$ . From this observation and (7.30), we get a covering of  $L_{(I,J)}$  by disks of diameter at most  $2 \max\{\eta_i(t) : 1 \leq i \leq H_{S_0(t)}(1, x) + 1\}$ , such that the sum of the  $\gamma$ -th powers of the diameters of disks in this covering is bounded above by

$$100 \, 2^{2+\gamma} \, E(t)^2 \sum_{i=1}^{H_{S_0(t)}(1,x)+1} \eta_i(t)^\beta. \tag{7.31}$$

We then need obtain a bound for  $E(t)$ . In the genealogical tree of fragments, the number of ends of a given fragment is at most the number of ends of its “parent” plus 1. Consequently  $E(t)$  is smaller than the largest generation of a fragment of  $S_0(t)$ . In our case  $\alpha = 0$ , the genealogy of fragments is described by a standard Yule process (indeed, each fragment gives birth to two new fragments at rate 1). Easy estimates show that  $E(t) \leq t^2$  for all large enough  $t$ , almost surely. On the other hand, Theorem 7.25 (iv) implies that

$$\limsup_{t \rightarrow \infty} \left( \exp(\kappa_{\nu_D}(\beta)t) \sum_{i=1}^{H_{S_0(t)}(1,x)+1} \eta_i(t)^\beta \right) < \infty, \quad \text{a.s.}$$

Since  $\beta > \beta^*$  we have  $\kappa_{\nu_D}(\beta) > 0$ . From the preceding display and the bound  $E(t) \leq t^2$  for  $t$  large, we now deduce that the quantity (7.31) tends to 0 as  $t \rightarrow \infty$ . The upper bound  $\dim L_{(I,J)} \leq \gamma$  follows. By (7.29) we have also  $\dim L_\infty \leq \gamma$  and since  $\gamma > \beta^* + 1$  was arbitrary, we conclude that  $\dim L_\infty \leq \beta^* + 1$ .

*Lower bound.* For  $(I, J) \in \mathcal{I}$ , let  $A_{(I,J)}$  be the set of all  $y \in I$  such that there exists  $z \in J$  with  $(y, z) \in S^*(\infty)$ . By [102, Proposition 2.3 (i)], we have

$$\dim(L_\infty) \geq \dim(A_{(I,J)}) + 1$$

for every  $(I, J) \in \mathcal{I}$  ([102] deals with hyperbolic geodesics instead of chords, but the argument is exactly the same). For any rational  $\delta \in ]0, 1/4[$ , set  $I_\delta = \{e^{2i\pi r} : \delta \leq r \leq \frac{1}{2} - \delta\}$ . Also set  $J_0 = \{e^{2i\pi r} : \frac{1}{2} \leq r \leq 1\}$ . We will prove that almost surely, for all  $\delta$  sufficiently small, we have

$$\dim(A_{(I_\delta, J_0)}) \geq \beta^*. \tag{7.32}$$

The desired lower bound for  $\dim(L_\infty)$  will then immediately follow.

In order to get the lower bound (7.32), we construct a suitable random measure on  $A_{(I_\delta, J_0)}^1$ . We define a finite random measure  $\mu_\delta$  on  $[\delta, \frac{1}{2} - \delta]$  by setting, for every  $r, s \in [\delta, \frac{1}{2} - \delta]$  with  $r \leq s$ ,

$$\mu_\delta([r, s]) = \min_{u \in [s, \frac{1}{2}]} \mathcal{M}_\infty(e^{2i\pi u}) - \min_{u \in [r, \frac{1}{2}]} \mathcal{M}_\infty(e^{2i\pi u}).$$

Clearly, if  $r$  belongs to the topological support of  $\mu_\delta$ , we have

$$\mathcal{M}_\infty(e^{2i\pi r}) = \min_{u \in [r, \frac{1}{2}]} \mathcal{M}_\infty(e^{2i\pi u}),$$

and thus there exists  $s \in [\frac{1}{2}, 1]$  such that

$$\mathcal{M}_\infty(e^{2i\pi r}) = \mathcal{M}_\infty(e^{2i\pi s}) = \min_{u \in [r, s]} \mathcal{M}_\infty(e^{2i\pi u}).$$

Therefore, with the notation of the previous section, we have  $r \stackrel{g_\infty}{\approx} s$  and also  $r \stackrel{g_\infty}{\approx} s$  from the proof of Theorem 7.2. It follows that  $(e^{2i\pi r}, e^{2i\pi s}) \in S^*(\infty)$  and  $e^{2i\pi r} \in A_{(I_\delta, J_0)}$ .

To summarize, if we denote the image of  $\mu_\delta$  under the mapping  $r \rightarrow e^{2i\pi r}$  by  $\nu_\delta$ , the measure  $\nu_\delta$  is supported on  $A_{(I_\delta, J_0)}$ . From the Hölder continuity properties of the process  $\mathcal{M}_\infty$ , we immediately get that for every  $\varepsilon > 0$  there exists a (random) constant  $C_\varepsilon$  such that the  $\nu_\delta$ -measure of any ball is bounded above by  $C_\varepsilon$  times the  $(\beta^* - \varepsilon)$ -th power of the diameter of the ball. The lower bound (7.32) now follows from standard results about Hausdorff measures, provided that we know that  $\nu_\delta$  is nonzero for  $\delta > 0$  small, a.s. However the total mass of  $\nu_\delta$  clearly converges to  $\mathcal{M}_\infty(-1) > 0$  as  $\delta \rightarrow 0$ . This completes the proof.

## 7.7 Convergence of discrete models

In this section, we prove Theorem 7.4. A key tool is the maximality property in Theorem 7.32. We will also need the following geometric lemma, which considers laminations that are “nearly maximal”.

**Lemma 7.36.** *Let  $S$  be a figela and  $\varepsilon \in ]0, 1[$ . Suppose that all fragments of  $S$  have mass smaller than  $\varepsilon/2\pi$  and at most 3 ends. Consider an arbitrary lamination*

$$L = \bigcup_{i \in I} [x_i y_i]$$

*where the chords  $[x_i y_i]$  do not cross. Suppose that the chords of the figela  $S$  belong to the collection  $\{[x_i y_i] : i \in I\}$ , and in particular  $L_S \subset L$ . Then any chord  $[x_i y_i]$ ,  $i \in I$  lies within Hausdorff distance less than  $\varepsilon$  from a chord of the figela  $S$ .*

We omit the easy proof, which should be clear from Fig. 6.

Let us turn to the proof of Theorem 7.4. We fix  $\varepsilon > 0$  and  $\delta \in ]0, 1/2[$ .

We use the genealogical structure of fragments as described in the beginning of the proof of Theorem 7.32. We first observe that we may fix an integer  $m$  sufficiently large such that with probability at least  $1 - \delta$  all the fragments  $R_u$  for  $u \in \{0, 1\}^m$  have mass less than  $\varepsilon/2\pi$ . Then, using Lemma 7.33, or rather the proof of this lemma, we can choose an integer  $M \geq m$  large enough so that the following holds with probability greater than  $1 - \delta$  : For every  $u \in \{0, 1\}^M$ , there exists an integer  $j(u) \in \{m, \dots, M\}$  such that the fragment  $R_{[u]_{j(u)}}$  has at most 3 ends.

From now on, we argue on the set where the preceding property holds and where all the fragments  $R_u$  for  $u \in \{0, 1\}^m$  have mass less than  $\varepsilon/2\pi$ . For every  $u \in \{0, 1\}^M$ , we



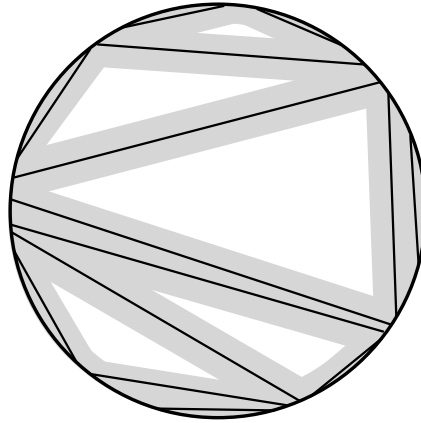

FIGURE 7.6 – Illustration of the proof of lemma 7.36 : The chords  $[x_i y_i]$  have to lie in the shaded part of the figure.

choose the integer  $j(u)$  as small as possible and set  $v(u) = [u]_{j(u)}$  to simplify notation. Then, if  $u, u' \in \{0, 1\}^M$ , the fragments  $R_{v(u)}$  and  $R_{v(u')}$  are either disjoint or equal. From this property, we easily get that there exists a figela  $L^*$  whose fragments are the sets  $R_{v(u)}$ ,  $u \in \{0, 1\}^M$ . By construction,  $L^*$  satisfies the assumptions of Lemma 7.36. Consequently, every chord appearing in the figela process lies within distance at most  $\varepsilon$  from a chord of  $L^*$ .

Consider now the discrete-time process  $(\Lambda_n)_{n \geq 0}$  of Section 7.1, where feet of chords belong to the set of  $n$ -th roots of unity. In this model we can introduce a labelling of fragments analogous to what we did in the continuous setting. For instance,  $R_0^n$  and  $R_1^n$  will be the fragments created by the first chord, ordered in a random way. Then we look for the first chord that falls in  $R_0$  (if any) and call  $R_{00}^n$  and  $R_{01}^n$  the new fragments created by this chord, and so on. In this way we get a collection  $(R_u^n)_{u \in \mathbb{T}^{(n)}}$ , which is indexed by a random finite subtree  $\mathbb{T}^{(n)}$  of  $\mathbb{T}$ . It is easy to verify that, for every integer  $p \geq 0$ ,  $\mathbb{P}[\mathbb{T}_p \subset \mathbb{T}^{(n)}]$  tends to 1 as  $n \rightarrow \infty$ .

For every  $u \in \mathbb{T}$ , write  $x_u$  and  $y_u$  for the feet of the first chord that will split  $R_u$  (again ordered in a random way). Introduce a similar notation  $x_u^n$  and  $y_u^n$  in the discrete setting (then of course  $x_u^n$  and  $y_u^n$  are only defined when  $u \in \mathbb{T}^{(n)}$  and  $u$  is not a leaf of  $\mathbb{T}^{(n)}$ ). Since feet of chords are chosen recursively uniformly over possible choices, both in the discrete and in the continuous setting, it should be clear that, for every integer  $p \geq 0$ ,

$$\left( (x_u^n, y_u^n) \right)_{u \in \mathbb{T}_p} \xrightarrow[n \rightarrow \infty]{(d)} \left( (x_u, y_u) \right)_{u \in \mathbb{T}_p}. \tag{7.33}$$

We apply this convergence with  $p = M$ . Using the Skorokhod representation theorem, we may assume that the preceding convergence holds almost surely. Then almost surely for  $n$  sufficiently large, every chord of the figela  $L^*$  (which must be of the form  $[x_u y_u]$  for some  $u \in \mathbb{T}_M$ ) lies within distance at most  $\varepsilon$  from a chord of  $\Lambda_n$ . Recalling the beginning of the proof, we see that, on an event of probability at least  $1 - 2\delta$ , every

chord appearing in the figela process lies within distance  $2\varepsilon$  from a chord of  $\Lambda_n$ , for all  $n$  sufficiently large.

We still need to prove the converse : We argue on the same event of probability at least  $1 - 2\delta$  and verify that, for  $n$  sufficiently large, every chord of  $\Lambda_n$  lies within distance  $2\varepsilon$  from the set  $L_\infty$ . To this end, we use a symmetric argument. Assuming that  $n$  is large enough so that  $\mathbb{T}_M \subset \mathbb{T}^{(n)}$ , we let  $\Lambda_n^*$  be the figela whose fragments are the sets  $R_{v(u)}^n$ ,  $u \in \{0, 1\}^M$ . The (almost sure) convergence (7.33) guarantees that every chord of the figela  $L^*$  is the limit as  $n \rightarrow \infty$  of the corresponding chord of  $\Lambda_n^*$ . It follows that, for  $n$  sufficiently large,  $\Lambda_n^*$  satisfies the assumptions of Lemma 7.36, and thus every chord of  $\Lambda_n$  lies within distance at most  $\varepsilon$  from a chord of  $\Lambda_n^*$ . Taking  $n$  even larger if necessary, we get that every chord of  $\Lambda_n$  lies within distance at most  $2\varepsilon$  from a chord of  $L^*$ . This completes the proof of the first assertion of Theorem 7.4.

The second assertion is proved in a similar manner. Plainly, a uniformly distributed random permutation of  $\{1, 2, \dots, n\}$  can be generated by first choosing  $\sigma(1)$  uniformly over  $\{1, \dots, n\}$ , then  $\sigma(2)$  uniformly over  $\{1, \dots, n\} \setminus \{\sigma(1)\}$ , and so on. From this simple remark, we see that the analogue of the convergence (7.33) still holds for the feet of chords of the figela  $\tilde{\Lambda}_n$ . The remaining part of the argument goes through without change.

## 7.8 Extensions and comments

### 7.8.1 Case $\alpha = 0$

Recall from Theorem 7.25 (iv) the definition of  $\mathcal{H}_0(x)$  as the almost sure limit of  $e^{-t/3} H_{S_0(t)}(1, x)$  as  $t \rightarrow \infty$ . Note that  $\mathcal{H}_0(x)$  is an analogue in the homogenous case  $\alpha = 0$  of  $\mathcal{M}_\infty(x)$ . In a way similar to what we did for  $\mathcal{M}_\infty(x)$ , one can verify that  $\mathbb{E}[\mathcal{H}_0(x)^p] < \infty$  for every real  $p \geq 1$ , and derive integral equations for the moments  $h_p(r) = \mathbb{E}[\mathcal{H}_0(e^{2i\pi r})^p]$ , for  $0 \leq r \leq 1$ . In the case  $p = 1$  we get

$$\frac{4}{3}h_1(r) = \int_0^r du \left(\frac{1-r}{1-u}\right)^2 \frac{2h_1(u)}{1-u} + \int_r^1 du \left(\frac{r}{u}\right)^2 \frac{2h_1(u)}{u}.$$

By differentiating this equation three times with respect to the variable  $r$  we get

$$\frac{2}{3}h_1'''(r) = h_1''(r) \left(\frac{1}{1-r} - \frac{1}{r}\right),$$

leading to the explicit formula

$$h_1(r) = \frac{8}{\pi} \sqrt{r(1-r)}.$$

For higher values of  $p$ , we get the following bounds.

**Proposition 7.37.** *For every integer  $p \geq 1$  and every  $\varepsilon > 0$ , there exists a constant  $K$  such that for every  $r \in [0, 1]$ ,*

$$h_p(r) \leq K(r(1-r))^{\frac{2p}{p+3}-\varepsilon}.$$

We omit the proof, which uses arguments similar to the proof of Proposition 7.27. The bounds of Proposition 7.37 are not sharp. Still they are good enough to apply Kolmogorov’s continuity criterion in order to get a continuous modification of the process  $(\mathcal{H}_0(x))_{x \in \mathbb{S}_1}$ .

### 7.8.2 Recursive self-similarity

Set  $Z_t = \mathcal{M}_\infty(e^{2i\pi t})$  for every  $t \in [0, 1]$ . A slightly more precise version of Proposition 7.29 shows that the process  $(Z_t)_{t \in [0,1]}$  satisfies the following remarkable self-similarity property. Let  $Z'$  and  $Z''$  be two independent copies of  $Z$  and let  $(U_1, U_2)$  be distributed according to the density  $2 \mathbf{1}_{\{0 < u_1 < u_2 < 1\}}$  and independent of the pair  $(Z, Z')$ . Then the process  $(\tilde{Z}_t)_{t \in [0,1]}$  defined by

$$\tilde{Z}_t = \begin{cases} (1 - (U_2 - U_1))^{\beta^*} Z'_{t/(1-(U_2-U_1))} & \text{if } 0 \leq t \leq U_1, \\ (1 - (U_2 - U_1))^{\beta^*} Z'_{U_1/(1-(U_2-U_1))} + (U_2 - U_1)^{\beta^*} Z''_{(t-U_1)/(U_2-U_1)} & \text{if } U_1 \leq t \leq U_2, \\ (1 - (U_2 - U_1))^{\beta^*} Z'_{(t-(U_2-U_1))/(1-(U_2-U_1))} & \text{if } U_2 \leq t \leq 1, \end{cases}$$

has the same distribution as  $(Z_t)_{t \in [0,1]}$ .

Informally, this means that we can write a decomposition of  $Z$  in two pieces according to the following device. Throw two independent uniform points  $U_1$  and  $U_2$  in  $[0, 1]$ . Condition on the event  $U_1 < U_2$  and set  $M = 1 - (U_2 - U_1)$ . Then start from a (scaled) copy of  $Z$  of duration  $[0, M]$  and “insert” at time  $U_1$  another independent scaled copy of  $Z$  of duration  $1 - M$ . Then the resulting random function has the same distribution as  $Z$ .

In [5], Aldous describes such a decomposition in three pieces for the Brownian excursion, which is closely related to the random geodesic lamination  $L_e$  of Theorem 7.10. Aldous also conjectures that there cannot exist a decomposition of the Brownian excursion in two pieces of the type described above.

It would be interesting to know whether the preceding decomposition of  $Z$  (along with some regularity properties) characterizes the distribution of  $Z$  up to trivial scaling constants. One may also ask whether the scaling exponent  $\beta^*$  is the only one for which there can exist such a decomposition in two pieces.

**Acknowledgments.** We are grateful to Grégory Miermont for a number of fruitful discussions. We also thank Jean Bertoin, François David and Kay Jörg Wiese for useful conversations. The second author is indebted to Frédéric Paulin for suggesting the study of recursive triangulations of the disk.

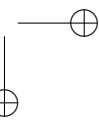
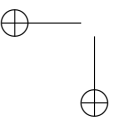
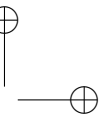
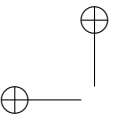

# Random Laminations and Multitype Branching Processes

LES RÉSULTATS DE CE CHAPITRE ONT ÉTÉ OBTENUS EN COLLABORATION AVEC YUVAL PERES ET ONT ÉTÉ SOUMIS POUR PUBLICATION.

We consider multitype branching processes arising in the study of random laminations of the disk. We classify these processes according to their subcritical or supercritical behavior and provide Kolmogorov-type estimates in the critical case corresponding to the random recursive lamination process of [47]. The proofs use the infinite dimensional Perron-Frobenius theory and quasi-stationary distributions.

## 8.1 Introduction

In this note we are interested in multitype branching processes that arise in the study of random recursive laminations. In order to introduce and motivate our results, let us briefly recall the basic construction of [47]. Consider a sequence  $U_1, V_1, U_2, V_2, \dots$  of independent random variables, which are uniformly distributed over the unit circle  $\mathbb{S}_1$ . We then construct inductively a sequence  $L_1, L_2, \dots$  of random closed subsets of the closed unit disk  $\mathbb{D}$ . To start with,  $L_1$  is set to be the (Euclidean) chord  $[U_1V_1]$  with endpoints  $U_1$  and  $V_1$ . Then at step  $n + 1$ , we consider two cases. Either the chord  $[U_{n+1}V_{n+1}]$  intersects  $L_n$ , and we put  $L_{n+1} = L_n$ . Or the chord  $[U_{n+1}V_{n+1}]$  does not intersect  $L_n$ , and we put  $L_{n+1} = L_n \cup [U_{n+1}V_{n+1}]$ . Thus, for every integer  $n \geq 1$ ,  $L_n$  is a disjoint union of random chords. See Fig. 8.1.

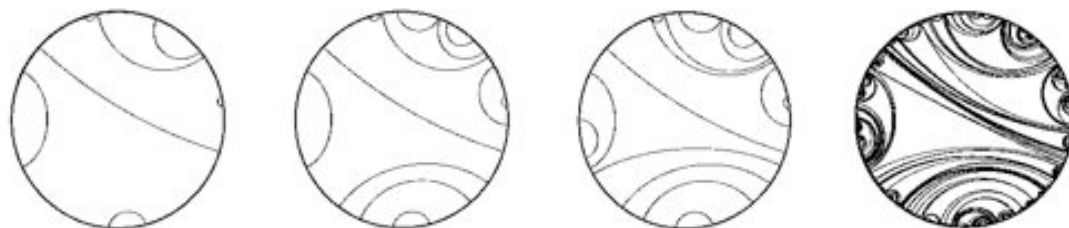

FIGURE 8.1 – An illustration of the process creating the sequence  $(L_n)_{n \geq 1}$ . We use hyperbolic chords rather than Euclidean chords for aesthetic reasons.

A fragment of  $L_n$  is a connected component of  $\overline{\mathbb{D}} \setminus L_n$ . These fragments have a natural genealogy that we now describe. The first fragment,  $\overline{\mathbb{D}}$ , is represented by  $\emptyset$ . Then the first chord  $[U_1 V_1]$  splits  $\overline{\mathbb{D}}$  into two fragments, which are viewed as the offspring of  $\emptyset$ . We then order these fragments in a random way : With probability  $1/2$ , the first child of  $\emptyset$ , which is represented by  $0$ , corresponds to the largest fragment and the second child, which is represented by  $1$ , corresponds to the other fragment. With probability  $1/2$  we do the contrary. We then iterate this device (see Fig. 8.2) so that each fragment appearing during the splitting process is labeled by an element of the infinite binary tree

$$\mathbb{T}_2 = \bigcup_{n \geq 0} \{0, 1\}^n, \quad \text{where } \{0, 1\}^0 = \{\emptyset\}.$$

If  $F$  is a fragment, we call *end* of  $F$ , any connected component of  $F \cap \mathbb{S}_1$ . For convenience, the full disk  $\overline{\mathbb{D}}$  is viewed as a fragment with  $0$  end. Consequently, we can associate to any  $u \in \mathbb{T}_2$  a label  $\ell(u)$  that corresponds to the number of ends of the corresponding fragment in the above process. Lemma 5.5 of [47] then entails that this random labeling of  $\mathbb{T}_2$  is described by the following branching mechanism : For any  $u \in \mathbb{T}_2$  labeled  $m \geq 0$ , choose  $m_1 \in \{0, 1, \dots, m\}$  uniformly at random and assign the values  $1 + m_1$  and  $1 + m - m_1$  to the two children of  $u$ . This is the multitype branching process we will be interested in. See Fig. 8.2.

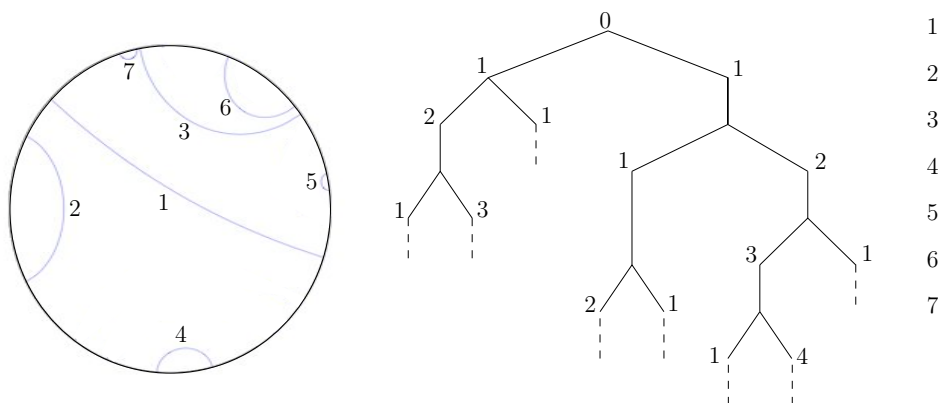

FIGURE 8.2 – On the left-hand side, the first 7 chords of the splitting process. On the right-hand side, the associated branching process corresponding to the number of ends of the fragments at their creations. Notice that we split the fragments according to the order of appearance of the chords, thus the binary tree on the right-hand side seems stretched.

We can also define a random labeling by using the above branching mechanism but starting with a value  $a \geq 0$  at the root  $\emptyset$  of  $\mathbb{T}_2$ , the probability distribution of this process will be denoted  $\mathbf{P}_a$  and its relative expectation  $\mathbf{E}_a$ . A *ray* is an infinite geodesic path  $\mathbf{u} = (u_1, u_2, \dots) \in \{0, 1\}^{\mathbb{N}}$  starting from the root  $\emptyset$  in  $\mathbb{T}_2$ . For any ray  $\mathbf{u} = (u_1, \dots, u_n, \dots)$  or any word of finite length  $u = (u_1, \dots, u_n)$ , we denote by  $[\mathbf{u}]_i$  or  $[u]_i$  the word  $(u_1, \dots, u_i)$  for  $1 \leq i \leq n$ , and  $[u]_0 = \emptyset$ .

**Theorem** ([47, Lemma 5.5]). *Almost surely, there exists no ray  $\mathbf{u}$  along which all the labels starting from 4 are bigger than or equal to 4,*

$$\mathbf{P}_4(\exists \mathbf{u} \in \{0, 1\}^{\mathbb{N}} : \ell([\mathbf{u}]_i) \geq 4, \forall i \geq 0) = 0.$$

The starting label 4 does not play any special role and can be replaced by any value bigger than 4. This theorem was proved and used in [47] to study certain properties of the random closed subset  $L_\infty = \overline{\cup L_n}$ , and in particular to prove that it is almost surely a *maximal* lamination (roughly speaking that the complement of  $L_\infty$  is made of disjoint triangles), see [47, Proposition 5.4]. One of the purposes of this note is to provide quantitative estimates related to this theorem. Specifically let

$$G_n = \{u \in \{0, 1\}^n : \ell([u]_i) \geq 4, \forall i \in \{0, 1, \dots, n\}\}$$

be the set of paths in  $\mathbb{T}_2$  joining the root to the level  $n$  along which the labels are bigger than or equal to 4.

**Theorem 8.1.** *The expected number of paths starting from the root and reaching level  $n$  along which the labels starting from 4 are bigger than or equal to 4 satisfies*

$$\mathbf{E}_4[\#G_n] \xrightarrow{n \rightarrow \infty} \frac{4}{e^2 - 1}. \tag{8.1}$$

Furthermore, there exist two constants  $0 < c_1 < c_2 < \infty$  such that the probability that  $G_n \neq \emptyset$  satisfies

$$\frac{c_1}{n} \leq \mathbf{P}_4(G_n \neq \emptyset) \leq \frac{c_2}{n}. \tag{8.2}$$

**Remark 8.2.** *These estimates are reminiscent of the critical case for Galton-Watson processes with finite variance  $\sigma^2 < \infty$ . Indeed if  $H_n$  denotes the number of vertices at height  $n$  in such a process then  $\mathbb{E}[H_n] = 1$  and Kolmogorov’s estimate [87] implies that  $\mathbb{P}[H_n \neq 0] \sim \frac{2}{\sigma^2 n}$ .*

The proof of Theorem 9.6.2 relies on identifying the quasi-stationary distribution of the labels along a fixed ray conditioned to stay bigger than or equal to 4. This is done in Section 8.2. In Section 3, we also study analogues of this branching random walk on the  $k$ -ary tree, for  $k \geq 3$ , coming from a natural generalization of the process  $(L_n)_{n \geq 0}$  where we replace chords by triangles, squares... see Fig. 8.3.

We prove in these cases that there is no critical value playing the role of 4 in the binary case.

**Acknowledgments.** The first author thanks Microsoft Research and the University of Washington, where most of this work was done, for their hospitality. We are also grateful to Jean-François Le Gall for precious comments and suggestions on a first version of this note.



FIGURE 8.3 – Extension of the process  $(L_n)_{n \geq 1}$  where we throw triangles or squares instead of chords.

## 8.2 The critical case

### 8.2.1 A martingale

Fix an arbitrary ray  $\mathbf{u}_0$  in  $\mathbb{T}_2$ , for example  $\mathbf{u}_0 = (0, 0, 0, 0, 0, \dots)$  and define  $X_n = \ell([\mathbf{u}_0]_n)$  for  $n \geq 0$ , so that  $X_n$  is the value at the  $n$ -th vertex on the fixed ray  $\mathbf{u}_0$  of the  $\mathbb{T}_2$ -indexed walk  $\ell$  starting from  $x_0 \geq 4$  at the root. Then  $(X_n)_{n \geq 0}$  is a homogeneous Markov chain with transition probabilities given by

$$P_2(x, y) = \frac{1}{x + 1} \mathbf{1}_{1 \leq y \leq x+1}.$$

We first recall some results derived in [47]. If  $\mathcal{F}_n$  is the canonical filtration of  $(X_n)_{n \geq 0}$  then a straightforward calculation leads to  $\mathbf{E}_{x_0}[X_{n+1} \mid \mathcal{F}_n] = 1 + X_n/2$ , hence the process  $M_n = 2^n(X_n - 2)$  is a martingale starting from  $x_0 - 2$ . For  $i \geq 1$ , we let  $T_i$  be the stopping time  $T_i = \inf\{n \geq 0 : X_n = i\}$ , and  $T = T_1 \wedge T_2 \wedge T_3$ . By the stopping theorem applied to the martingale  $(M_n)_{n \geq 0}$ , we obtain for every  $n \geq 0$ ,

$$x_0 - 2 = \mathbf{E}_{x_0}[M_{n \wedge T}] = \mathbf{E}_{x_0}[-2^{T_1} \mathbf{1}_{\{T_1 = T \leq n\}}] + 0 + \mathbf{E}_{x_0}[2^{T_3} \mathbf{1}_{\{T_3 = T \leq n\}}] + \mathbf{E}_{x_0}[2^n(X_n - 2) \mathbf{1}_{\{T > n\}}].$$

One can easily check from the transition kernel of the Markov chain  $(X_n)_{n \geq 0}$  that for every  $i \geq 1$ ,  $\mathbf{P}_{x_0}[T_1 = T = i] = \mathbf{P}_{x_0}[T_2 = T = i] = \mathbf{P}_{x_0}[T_3 = T = i]$ . Hence, the equality in the last display becomes

$$x_0 - 2 = \mathbf{E}_{x_0}[2^n(X_n - 2) \mathbf{1}_{\{T > n\}}],$$

or equivalently

$$x_0 - 2 = 2^n \mathbf{P}_{x_0}[T > n] \mathbf{E}_{x_0}[X_n - 2 \mid T > n]. \tag{8.3}$$

Our strategy here is to compute the stationary distribution of  $X_n$  conditionally on the non extinction event  $\{T > n\}$ , in order to prove the convergence of  $\mathbf{E}_4[X_n \mid T > n]$  and finally to get asymptotics for  $\mathbf{P}_4[T > n]$ . Before any calculation, we make a couple of simple remarks. Obviously  $\mathbf{E}_{x_0}[X_n - 2 \mid T > n] \geq 2$ , and thus we get  $2^n \mathbf{P}_{x_0}(T > n) \leq \frac{x_0 - 2}{2}$ . Since there are exactly  $2^n$  paths joining the root  $\emptyset$  of  $\mathbb{T}_2$  to the level  $n$ , we



deduce that the number  $\#G_n$  of paths joining  $\emptyset$  to the level  $n$  along which the labels are bigger than or equal to 4 satisfies

$$\mathbf{E}_{x_0}[\#G_n] \leq \frac{x_0 - 2}{2}. \tag{8.4}$$

Notice that a simple argument shows that if  $4 \leq x_0 \leq x_1$  then the chain  $X_n$  starting from  $x_0$  and the chain  $X'_n$  starting from  $x_1$  can be coupled in such a way that  $X_n \leq X'_n$  for all  $n \geq 0$ .

### 8.2.2 The quasi-stationary distribution

We consider the substochastic matrix of the Markov chain  $X_n$  killed when it reaches 1, 2 or 3 : This is the matrix  $(\tilde{P}_2(x, y))_{x, y \geq 4}$  given by

$$\tilde{P}_2(x, y) = \frac{1}{x + 1} \mathbf{1}_{y \leq x+1}.$$

We will show that  $\tilde{P}_2$  is a 2-recurrent positive matrix, in the sense of [130, Lemma 1]. For that purpose we seek left and right non-negative eigenvectors of  $\tilde{P}_2$  for the eigenvalue  $1/2$ . In other words we look for two sequences  $(g(x))_{x \geq 4}$  and  $(f(x))_{x \geq 4}$  of non-negative real numbers such that  $f(4) = g(4) = 1$  (normalization) and for every  $x \geq 4$

$$g(x) = 2 \sum_{y \geq 4} g(y) \tilde{P}_2(y, x) = 2 \sum_{y=(x-1) \vee 4}^{\infty} \frac{g(y)}{y + 1}, \tag{8.5}$$

$$f(x) = 2 \sum_{y \geq 4} \tilde{P}_2(x, y) f(y) = \frac{2}{x + 1} \sum_{y=4}^{x+1} f(y). \tag{8.6}$$

We start with the left eigenvector  $g$ . From (8.5), we get  $g(5) = g(4) = 0$ , and  $g(i) - g(i + 1) = \frac{2}{i} g(i - 1)$  for  $i \geq 5$ . Letting

$$G(z) = \sum_{i \geq 4} \frac{z^{i+1}}{i + 1} g(i), \quad 0 \leq z < 1,$$

the last observations lead to the following differential equation for  $G$

$$2G(z) = z^{-1}(z - 1)G'(z) + z^3,$$

with the condition  $G(z) = z^5/5 + o(z^5)$ . A simple computation yields  $G(z) = 3/4 \exp(2z) \times (z - 1)^2 + (z^3/2 + 3z^2/4 - 3/4)$ . After normalization, the generating function  $G_{1/2}(z) = \sum_{i \geq 4} g_{1/2}(i) z^i$  of the unique probability distribution  $g_{1/2}$  which is a left eigenvector for the eigenvalue  $1/2$  is given by

$$G_{1/2}(z) = \frac{z}{2} (\exp(2z)(z - 1) + z + 1),$$

that is

$$g_{1/2}(i) = \frac{2^{i-3}(i - 3)}{(i - 1)!} \mathbf{1}_{i \geq 4}.$$

This left eigenvector is called the *quasi-stationary distribution* of  $X_n$  conditioned on non-extinction. For the right eigenvector  $f$ , a similar approach using generating functions is possible, but it is also easy to check by induction that

$$f(i) = \frac{i-2}{2} \mathbf{1}_{i \geq 4},$$

satisfies (8.6). Hence the condition (iii) of Lemma 1 in [130] is fulfilled and the substochastic matrix  $\tilde{P}_2$  is 2-recurrent positive. For every  $x \geq 4$ , set  $q_n(x) = \mathbf{P}_4(X_n = x \mid T > n) = \mathbf{P}_4(T > n)^{-1} \tilde{P}_2^n v(x)$  where  $v$  stands for the “vector”  $(v_i)_{i \geq 4}$  with  $v_4 = 1$  and  $v_i = 0$  if  $i \geq 5$ . Theorem 3.1 of [130] then implies that

$$q_n(x) \xrightarrow{n \rightarrow \infty} g_{1/2}(x). \tag{8.7}$$

Unfortunately this convergence does not immediately imply that  $\mathbf{E}_4[X_n \mid T > n] \rightarrow \mathbb{E}[X]$  where  $X$  is distributed according to  $g_{1/2}$ . But this will follow from the next proposition.

**Proposition 8.3.** *For every  $n \geq 0$  the sequence  $\left(\frac{q_n(x)}{g_{1/2}(x)}\right)_{x \geq 4}$  is decreasing.*

*Démonstration.* By induction on  $n \geq 0$ . For  $n = 0$  the statement is true. Suppose it holds for  $n \geq 0$ . By the definition of  $q_{n+1}$ , for  $x \geq 4$  we have

$$\begin{aligned} q_{n+1}(x) &= \mathbf{P}_4(X_{n+1} = x \mid T > n + 1) \\ &= \frac{1}{\mathbf{P}_4(T > n + 1)} \sum_{z \geq 4} \mathbf{P}_4(X_n = z, X_{n+1} = x, T > n) \\ &= \frac{\mathbf{P}_4(T > n)}{\mathbf{P}_4(T > n + 1)} \sum_{z \geq (x-1) \vee 4} \frac{q_n(z)}{z + 1} \end{aligned} \tag{8.8}$$

We need to verify that, for every  $x \geq 4$ , we have  $q_{n+1}(x)g_{1/2}(x+1) \geq q_{n+1}(x+1)g_{1/2}(x)$  or equivalently, using (8.8) and (8.5) with  $g = g_{1/2}$ , that

$$\left( \sum_{z \geq x \vee 4} \frac{g_{1/2}(z)}{z + 1} \right) \left( \sum_{z \geq (x-1) \vee 4} \frac{q_n(z)}{z + 1} \right) \geq \left( \sum_{z \geq (x-1) \vee 4} \frac{g_{1/2}(z)}{z + 1} \right) \left( \sum_{z \geq x \vee 4} \frac{q_n(z)}{z + 1} \right)$$

For  $x = 4$  this inequality holds. Otherwise, if  $x > 4$ , we have to prove that

$$q_n(x-1) \sum_{z \geq x \vee 4} \frac{g_{1/2}(z)}{z + 1} \geq g_{1/2}(x-1) \sum_{z \geq x \vee 4} \frac{q_n(z)}{z + 1}. \tag{8.9}$$

Set  $A_x = \frac{q_n(x-1)}{g_{1/2}(x-1)}$  to simplify notation. The induction hypothesis guarantees that  $q_n(z) \leq A_x g_{1/2}(z)$  for every  $z \geq x$ , and therefore

$$\sum_{z \geq x \vee 4} \frac{q_n(z)}{z + 1} \leq A_x \sum_{z \geq x \vee 4} \frac{g_{1/2}(z)}{z + 1}.$$

This gives the bound (8.9) and completes the proof of the proposition. □

By Proposition 8.3 we have for every  $x \geq 1$ ,  $\frac{q_n(x)}{g_{1/2}(x)} \leq \frac{q_n(4)}{g_{1/2}(4)} \leq C$ , where  $C = \sup_{n \geq 0} \frac{q_n(4)}{g_{1/2}(4)} < \infty$  by (8.7). This allows us to apply dominated convergence to get

$$\mathbf{E}_4[X_n | T > n] = \sum_{x \geq 4} x q_n(x) \xrightarrow{n \rightarrow \infty} \sum_{x \geq 4} x g_{1/2}(x) = G'_{1/2}(1) = \frac{e^2 + 3}{2}.$$

Using (8.3) we then conclude that

$$2^n \mathbf{P}_4[T > n] \xrightarrow{n \rightarrow \infty} \frac{4}{e^2 - 1}. \tag{8.10}$$

### 8.2.3 Proof of Theorem 9.6.2

We first introduce some notation. We denote the tree  $\mathbb{T}_2$  truncated at level  $n$  by  $\mathbb{T}_2^{(n)}$ . For every  $u = (u_1, \dots, u_n) \in \{0, 1\}^n$ , and every  $j \in \{0, 1, \dots, n\}$ , recall that  $[u]_j = (u_1, \dots, u_j)$ , and if  $j \geq 1$ , also set  $[u]_j^* = (u_1, \dots, u_{j-1}, 1 - u_j)$ . We say that  $j \in \{0, 1, \dots, n-1\}$  is a *left turn* (resp. *right turn*) of  $u$  if  $u_{j+1} = 0$  (resp.  $u_{j+1} = 1$ ). A *down step* of  $u$  is a time  $j \in \{0, 1, \dots, n-1\}$  such that

$$\ell([u]_j) - \ell([u]_{j+1}) \geq 2.$$

Note that if  $j$  is a down step of  $u$  then  $\ell([u]_{j+1}^*) = 2 + \ell([u]_j) - \ell([u]_{j+1}) \geq 4$ . The set of all  $j \in \{0, 1, \dots, n-1\}$  that are left turns, resp. right turns, resp. down steps, of  $u$  is denoted by  $L(u)$ , resp.  $R(u)$ , resp.  $D(u)$ . We endow  $\mathbb{T}_2$  with the lexicographical order  $\preceq$ , and say that a path  $u \in \{0, 1\}^n$  is on the left (resp. right) of  $v \in \{0, 1\}^n$  if  $u \preceq v$  (resp.  $v \preceq u$ ). A vertex of  $\{0, 1\}^n$  will be identified with the path it defines in  $\mathbb{T}_2^{(n)}$ . If  $u, v \in \mathbb{T}_2$  we let  $u \wedge v$  be the last common ancestor of  $u$  and  $v$ .

*Proof of Theorem 9.6.2. LOWER BOUND.* We use a second moment method. Recall that

$$G_n = \{u \in \{0, 1\}^n : \ell([u]_i) \geq 4, \forall i \in \{0, 1, \dots, n\}\}$$

is the set of all paths in  $\mathbb{T}_2^{(n)}$  from the root to the level  $n$  along which the labels are bigger than or equal to 4. A path in  $G_n$  is called "good". Using (8.10), we can compute the expected number of good paths and get

$$\mathbf{E}_4[\#G_n] = 2^n \mathbf{P}_4[T > n] \xrightarrow{n \rightarrow \infty} \frac{4}{e^2 - 1},$$

as  $n \rightarrow \infty$ , which proves the convergence (8.1) in the theorem. For  $u \in G_n$  and  $j \in \{0, 1, \dots, n\}$ , we let  $\text{Right}(u, j)$  be the set of all good paths to the right of  $u$  that diverge from  $u$  at level  $j$ ,

$$\text{Right}(u, j) = \{v \in G_n : u \preceq v \text{ and } u \wedge v = [u]_j\}.$$

In particular, if  $j$  is a right turn for  $u$ , that is  $u_{j+1} = 1$ , then  $\text{Right}(u, j) = \emptyset$ . Furthermore  $\text{Right}(u, n) = \{u\}$ . Let us fix a path  $u \in \{0, 1\}^n$ , and condition on  $u \in G_n$  and on the labels along  $u$ . Let  $j \in \{0, 1, 2, \dots, n\}$ . Note that the first vertex of a path in

Right( $u, j$ ) that is not an ancestor of  $u$  is  $[u]_{j+1}^*$  and its label is  $2 + \ell([u]_j) - \ell([u]_{j+1})$ , so if we want Right( $u, j$ ) to be non-empty, the time  $j$  must be a down step of  $u$ . If  $j$  is a left turn and a down step for  $u$ , the subtree  $\{w \in \mathbb{T}_2^{(n)} : w \wedge [u]_j^* = [u]_j^*\}$  on the right of  $[u]_j$  is a copy of  $\mathbb{T}_2^{(n-j-1)}$ , whose labeling starts at  $\ell([u]_{j+1}^*)$ . Hence thanks to (8.4) we get

$$\mathbf{E}_4[\#\text{Right}(u, j) \mid u \in G_n, (\ell([u]_i))_{0 \leq i \leq n}] \leq \frac{\ell([u]_{j+1}^*) - 2}{2} = \frac{\ell([u]_j) - \ell([u]_{j+1})}{2}.$$

Since the labels along the ancestral line of  $u$  cannot increase by more than one at each step, if  $u \in G_n$  we have  $\sum_{i=0}^{n-1} |\ell([u]_{i+1}) - \ell([u]_i)| \mathbf{1}_{i \in \text{D}(u)} \leq n$ . Combining these inequalities, we obtain

$$\mathbf{E}_4 \left[ \sum_{j=0}^n \#\text{Right}(u, j) \mid u \in G_n, (\ell([u]_i))_{0 \leq i \leq n} \right] \leq \frac{n}{2}.$$

We can now bound  $\mathbf{E}_4[\#G_n^2]$  from above :

$$\begin{aligned} \mathbf{E}_4[\#G_n^2] &\leq 2\mathbf{E}_4 \left[ \sum_{u \in \{0,1\}^n} \sum_{u \preceq v} \mathbf{1}_{u \in G_n} \mathbf{1}_{v \in G_n} \right] \\ &= 2 \sum_{u \in \{0,1\}^n} \mathbf{P}_4(u \in G_n) \mathbf{E}_4 \left[ \sum_{u \preceq v} \mathbf{1}_{v \in G_n} \mid u \in G_n \right] \\ &= 2 \sum_{u \in \{0,1\}^n} \mathbf{P}_4(u \in G_n) \mathbf{E}_4 \left[ \sum_{j=0}^n \#\text{Right}(u, j) \mid u \in G_n \right] \\ &\leq n. \end{aligned} \tag{8.11}$$

The lower bound of Theorem 9.6.2 directly follows from the second moment method : Using (8.1) and (8.11) we get the existence of  $c_1 > 0$  such that

$$\mathbb{P}[\#G_n > 0] \geq \frac{\mathbb{E}[\#G_n]^2}{\mathbb{E}[(\#G_n)^2]} \geq \frac{c_1}{n}. \tag{8.12}$$

UPPER BOUND. We will first provide estimates on the number of down steps of a fixed path  $u \in \{0,1\}^n$ . Recall that L( $u$ ), R( $u$ ) and D( $u$ ) respectively denote the left turns, right turns, and down steps times of  $u$ .

**Lemma 8.4.** *There exists a constant  $c_3 > 0$  such that, for every  $n \geq 0$  and every  $u_0 \in \{0,1\}^n$*

$$\mathbf{P}_4(u_0 \in G_n, \#\text{D}(u_0) \leq c_3 n) \leq c_3^{-1} 2^{-n} \exp(-c_3 n).$$

*Démonstration.* We use the notation of Section 8.2.1. For any set  $A \subset \{0, 1, \dots, n-1\}$  and  $m \in \{0, 1, \dots, n - \#A\}$ , with the notation  $N_n^A = \#\{j \in \{0, 1, \dots, n-1\} \setminus A : X_j = 5\}$  we have from [47, formula (27)]

$$\mathbf{P} \left[ X_{j+1} \geq (X_j - 1) \vee 4, \forall j \in \{0, 1, \dots, n-1\} \setminus A, N_n^A = m \right] \leq \left(\frac{1}{2}\right)^m \left(\frac{3}{7}\right)^{n-m-\#A},$$

We will first obtain crude estimates for  $N_n^A$ . Note that  $N_n^A \leq N_n^\emptyset$  and that  $\sup_{i \geq 1} P_2(i, 5) = \frac{1}{5}$ , so that for any  $B \subset \{0, 1, \dots, n\}$  we have

$$\mathbb{P}[X_i = 5, \forall i \in B] \leq 5^{-\#B}.$$

By summing this bound over all choices of  $B$  with  $\#B \geq m$  we get  $\mathbb{P}[N_n^\emptyset \geq m] \leq 2^n 5^{-m}$  for every  $m \in \{0, 1, \dots, n\}$ . Let  $\kappa_1 \in (0, 1/2)$  and  $\kappa_2 \in (0, 1)$  such that  $\kappa_1 + \kappa_2 < 1$ . We have

$$\begin{aligned} & \mathbb{P}[u_0 \in G_n, \#D(u_0) \leq \kappa_1 n] \\ & \leq \mathbb{P}[u_0 \in G_n, \#D(u_0) \leq \kappa_1 n, N_n^\emptyset \leq \kappa_2 n] + \mathbb{P}[N_n^\emptyset \geq \kappa_2 n] \\ & \leq \sum_{\substack{A \subset \{0, 1, \dots, n-1\} \\ \#A \leq \kappa_1 n}} \mathbf{P}[X_{j+1} \geq (X_j - 1) \vee 4, \forall 0 \leq j \leq n-1, j \notin A; N_n^A \leq \kappa_2 n] + \mathbb{P}[N_n^\emptyset \geq \kappa_2 n] \\ & \leq (\lfloor \kappa_2 n \rfloor + 1) \sum_{\substack{A \subset \{0, 1, \dots, n-1\} \\ \#A \leq \kappa_1 n}} \left(\frac{7}{6}\right)^{\lfloor \kappa_2 n \rfloor} \left(\frac{3}{7}\right)^{n - \lfloor \kappa_1 n \rfloor} + \mathbb{P}[N_n^\emptyset \geq \kappa_2 n] \\ & \leq n \binom{n}{\lfloor \kappa_1 n \rfloor} \left(\frac{7}{6}\right)^{\lfloor \kappa_2 n \rfloor} \left(\frac{3}{7}\right)^{n - \lfloor \kappa_1 n \rfloor} + 2^n 5^{-\lfloor \kappa_2 n \rfloor} \end{aligned} \tag{8.13}$$

Notice that for every  $A > 1$  we can choose  $\kappa_1 > 0$  small enough so that  $n \binom{n}{\lfloor \kappa_1 n \rfloor} \leq A^n$  for  $n$  large enough. Furthermore

$$\left(\frac{7}{6}\right)^{\lfloor \kappa_2 n \rfloor} \left(\frac{3}{7}\right)^{n - \lfloor \kappa_1 n \rfloor} = 2^{-n} 2^{\lfloor \kappa_1 n \rfloor} \left(\frac{6}{7}\right)^{n - \lfloor \kappa_1 n \rfloor - \lfloor \kappa_2 n \rfloor},$$

and by choosing  $\kappa_1$  even smaller if necessary we can ensure that the right hand side of (8.13) is bounded by  $c_3^{-1} 2^{-n} \exp(-c_3 n)$  for some  $c_3 > 0$ .  $\square$

We use the last lemma to deduce that

$$n \mathbf{P}_4(\exists u \in G_n, \#D(u) \leq c_3 n) \leq \frac{n}{c_3} \exp(-c_3 n) \xrightarrow{n \rightarrow \infty} 0. \tag{8.14}$$

We now argue on the event  $E_L = \{\exists u \in G_n, \#(D(u) \cap L(u)) \geq c_3 n/2\}$ . On this event there exists a path  $u \in G_n$  with at least  $c_3 n/2$  down steps which are also left turns. Conditionally on this event we consider the left-most path  $P$  of  $G_n$  satisfying these properties, that is

$$P = \min_{\leq} \{u \in G_n, \#(D(u) \cap L(u)) \geq c_3 n/2\}.$$

A moment's thought shows that conditionally on  $P$  and on the values of the labels along the ancestral line of  $P$ , the subtrees of  $\mathbb{T}_2^{(n)}$  hanging on the right-hand side of  $P$ , that are the offsprings of the points  $[P]_{j+1}^*$  for  $j \in L(P)$ , are independent and distributed as labeled trees started at  $\ell([P]_{j+1}^*)$ .

Hence conditionally on  $P$  and on the labels  $((\ell([P]_i), 0 \leq i \leq n)$ , for any  $j \in L(P) \cap D(P)$  the expected number of paths belonging to the set  $\text{Right}(P, j)$  (defined in the proof of the lower bound) is

$$\begin{aligned} \mathbf{E}_4 \left[ \# \text{Right}(P, j) \mid P, (\ell([P]_i))_{0 \leq i \leq n} \right] &= 2^{n-j-1} \mathbf{P}_{\ell([P]_{j+1}^*)} (T > n - j - 1) \\ &\geq 2^{n-j-1} \mathbf{P}_4 (T > n - j - 1) \\ &\geq \kappa_3 > 0, \end{aligned} \tag{8.15}$$

where  $\kappa_3$  is a positive constant independent of  $n$  whose existence follows from (8.10). Thus we have

$$\begin{aligned} \mathbf{E}_4[\#G_n \mid E_L] &= \mathbf{E}_4 \left[ \mathbb{E} \left[ \sum_{j=0}^n \# \text{Right}(P, j) \mid P, (\ell([P]_i))_{0 \leq i \leq n} \right] \mid E_L \right] \\ &\geq \kappa_3 \mathbf{E}_4[\#(D(P) \cap L(P)) \mid E_L]. \\ &\geq \frac{c_3 \kappa_3}{2} n. \end{aligned} \tag{8.16}$$

Since  $\mathbf{P}_4(E_L) \leq \mathbf{E}_4[\#G_n] / \mathbf{E}_4[\#G_n \mid E_L]$  we can use (8.1) to obtain  $\mathbf{P}_4(E_L) \leq \kappa_4/n$  for some constant  $\kappa_4 > 0$ . By a symmetry argument, the same bound holds for the event  $E_R = \{\exists u \in G_n, \#(D(u) \cap R(u)) \geq c_3 n/2\}$ . Since  $\{G_n \neq \emptyset\}$  is the union of the events  $E_R, E_L$  and  $\{\exists u \in G_n, \#D(u) \leq c_3 n\}$ , we easily deduce the upper bound of the theorem from the previous considerations and (8.14).  $\square$

### 8.3 Extensions

Fix  $k \geq 2$ . We can extend the recursive construction presented in the introduction by throwing polygons instead of chords : This will yield an analogue of the multitype branching process on the full  $k$ -ary tree. Formally if  $x_1, \dots, x_k$  are  $k$  (distinct) points of  $\mathbb{S}_1$  we denote by  $\text{Pol}(x_1, \dots, x_k)$  the convex closure of  $\{x_1, \dots, x_k\}$  in  $\overline{\mathbb{D}}$ . Let  $(U_{i,j} : 1 \leq j \leq k, i \geq 1)$  be independent random variables that are uniformly distributed over  $\mathbb{S}_1$ . We construct inductively a sequence  $L_1^k, L_2^k, \dots$  of random closed subsets of the closed unit disk  $\overline{\mathbb{D}}$ . To start with,  $L_1^k$  is  $\text{Pol}(U_{1,1}, \dots, U_{1,k})$ . Then at step  $n + 1$ , we consider two cases. Either the polygon  $P_{n+1} := \text{Pol}(U_{n+1,1}, \dots, U_{n+1,k})$  intersects  $L_n^k$ , and we put  $L_{n+1}^k = L_n^k$ . Or the polygon  $P_{n+1}$  does not intersect  $L_n^k$ , and we put  $L_{n+1}^k = L_n^k \cup P_{n+1}$ . Thus, for every integer  $n \geq 1$ ,  $L_n^k$  is a disjoint union of random  $k$ -gons. In a way very similar to what we did in the introduction we can identify the genealogy of the fragments appearing during this process with the complete  $k$ -ary tree

$$\mathbb{T}_k = \bigcup_{i \geq 0} \{0, 1, \dots, k-1\}^i, \quad \text{where } \{0, 1, \dots, k-1\}^0 = \{\emptyset\}.$$

Then the number of ends of the fragments created during this process gives a labeling  $\ell^k$  of  $\mathbb{T}_k$  whose distribution can be described inductively by the following branching mechanism (this is an easy extension of [47, Lemma 5.5]) : For  $u \in \mathbb{T}_k$  with label  $m \geq 0$  we choose a decomposition  $m = m_1 + m_2 + \dots + m_k$  with  $m_1, m_2, \dots, m_k \in \{0, 1, \dots, m\}$ , uniformly at random among all  $\binom{m+k-1}{k-1}$  possible choices, and we assign the labels

$m_1 + 1, m_2 + 1, \dots, m_k + 1$  to the children of  $\emptyset$ . Again the distribution of the labeling  $\ell^k$  of  $\mathbb{T}_k$  obtained if we use the above branching mechanism but started from  $a \geq 0$  at the root will be denoted by  $\mathbf{P}_a$  and its expectation by  $\mathbf{E}_a$ . We use the same notation as in the binary case and are interested in a similar question : For which  $a \geq 0$  does there exist with positive probability a ray  $\mathbf{u}$  such that  $\ell^k([\mathbf{u}]_i) \geq a$  for every  $i \geq 0$ ? Specifically, the value  $a$  is called *subcritical* for the process  $(\ell^k(u), u \in \mathbb{T}_k)$  when there exists a constant  $c > 0$  such that

$$\mathbf{P}_a(\exists u \in \{0, 1, \dots, k-1\}^n : \ell^k([u]_i) \geq a, \forall i \in \{0, 1, \dots, n\}) \leq \exp(-cn).$$

It is called *supercritical* when there exists a constant  $c > 0$  such that we have both

$$\begin{cases} \mathbf{P}_a(\exists \mathbf{u} \in \{0, 1, \dots, k-1\}^{\mathbb{N}} : \ell^k([\mathbf{u}]_i) \geq a, \forall i \in \{0, 1, \dots\}) \geq c, \\ \mathbf{E}_a[\#\{u \in \{0, 1, \dots, k-1\}^n : \ell^k([u]_i) \geq a, \forall i \in \{0, 1, \dots, n\}\}] \geq \exp(cn). \end{cases}$$

Note that a deterministic argument shows that if  $k \geq 2$  and  $a = 2$ , there always exists a ray with labels greater than or equal to 2, also when  $k = 2$  and  $a = 3$  there exists a ray with labels greater than 3. The case  $k = 2$  and  $a = 4$  has been treated in our main theorem. We have the following classification of all remaining cases :

**Theorem 8.5.** *We have the following properties for the process  $\ell^k$ ,*

- for  $k = 2$  and  $a \geq 5$  the process is subcritical,
- for  $k = 3$  the process is subcritical for  $a \geq 4$ , and supercritical for  $a = 3$ ,
- for  $k \geq 4$  and  $a \geq 3$  the process is subcritical.

*Démonstration.* SUPERCRITICAL CASE  $k = 3$  AND  $a = 3$ . We will prove that for  $k = 3$  and  $a = 3$ , the process is supercritical. Similarly as in Section 8.2.1 we consider the tree-indexed process  $\ell^3$  on a fixed ray of  $\mathbb{T}_3$ , say  $\{0, 0, 0, \dots\}$ . Then the process  $Y_n$  given by the  $n$ -th value of  $\ell^3$  started from 3 along this ray is a homogeneous Markov chain with transition matrix given by

$$P_3(x, y) = \frac{2(x+2-y)}{(x+1)(x+2)} \mathbf{1}_{1 \leq y \leq x+1}.$$

We introduce the stopping times  $T_i = \inf\{n \geq 0, Y_n = i\}$  for  $i = 1, 2$  and set  $T = T_1 \wedge T_2$ . We consider a modification of the process  $Y_n$  that we denote  $\bar{Y}_n$ , which has the same transition probabilities as  $Y_n$  on  $\{1, 2, 3, 4\}$ , but the transition between 4 and 5 for  $Y_n$  is replaced by a transition from 4 to 4 for  $\bar{Y}_n$ . Thus we have  $\bar{Y}_n \leq 4$  and an easy coupling argument shows that we can construct  $Y_n$  and  $\bar{Y}_n$  simultaneously in such a way that  $\bar{Y}_n \leq Y_n$  for all  $n \geq 0$ . Hence we have the following stochastic inequality

$$\bar{T} \leq T,$$

with an obvious notation for  $\bar{T}$ . To evaluate  $\bar{T}$  we consider the subprocess  $\bar{Y}_{n \wedge \bar{T}}$  which is again a Markov chain whose transition matrix restricted to  $\{3, 4\}$  is

$$\begin{pmatrix} 1/5 & 1/10 \\ 1/5 & 1/5 \end{pmatrix}.$$

The largest eigenvalue  $\lambda_{\max}$  of this matrix is greater than 0.34, which implies that

$$\mathbf{P}_3 T > n \geq \mathbf{P}_3(\bar{T} > n) \geq \kappa_5(0.34)^n,$$

for some constant  $\kappa_5 > 0$  independent of  $n$ . It follows that the expected number of paths starting at the root  $\emptyset$  of  $\mathbb{T}_3$  that have labels greater than or equal to 3 up to level  $n$ , which is  $3^n \mathbb{P}[T > n]$ , eventually becomes strictly greater than 1 : There exists  $n_0 \geq 1$  such that  $\mathbf{P}_3(T > n) > 3^{-n}$  for  $n \geq n_0$ . A simple coupling argument shows that the process  $\ell^3$  started from  $a \geq 3$  stochastically dominates the process  $\ell^3$  started from 3. Consequently, if we restrict our attention to the levels that are multiple of  $n_0$  and declare that  $v$  is a descendant of  $u$  if along the geodesic between  $u$  and  $v$  the labels of  $\ell^3$  are larger than 3, then this restriction stochastically dominates a supercritical Galton-Watson process. Hence the value 3 is supercritical for  $\ell^3$ .

SUBCRITICAL CASE  $k = 3$  AND  $a = 4$ . As in the binary case we let

$$\tilde{P}_3(x, y) = \frac{2(x+2-y)}{(x+1)(x+2)} \mathbf{1}_{4 \leq y \leq x+1},$$

be the substochastic matrix of the process  $Y_n$  started at 4 and killed when it hits 1, 2 or 3. We will construct a positive vector  $(h(x))_{x \geq 4}$  such that  $\sum_x h(x) < \infty$  and

$$h \cdot \tilde{P}_3 \leq \lambda h, \tag{8.17}$$

for some positive  $\lambda < 1/3$ , where we use the notation  $h \cdot \tilde{P}_3(y) = \sum_x h(x) \tilde{P}_3(x, y)$ . This will imply that

$$\mathbb{P}[T > n] \leq \frac{\sum_x h(x)}{h(4)} \lambda^n,$$

where  $T$  is the first hitting time of  $\{1, 2, 3\}$  by the process  $Y_n$  started at 4. The subcriticality of the case  $k = 3$  and  $a = 4$  follows from the preceding bound since there are  $3^n$  paths up to level  $n$  and  $\lambda < 1/3$ . To show the existence of a positive vector  $x$  satisfying (8.17) we begin by studying the largest eigenvalue of a finite approximation of the infinite matrix  $\tilde{P}_3$ . To be precise let  $\tilde{P}_3^{(30)} = (\tilde{P}_3(i, j))_{4 \leq i, j \leq 30}$ . A numerical computation with Maple<sup>©</sup> gives

$$\lambda_{\max} := \max \left\{ \text{Eigenvalues}(\tilde{P}_3^{(30)}) \right\} \simeq 0.248376642883065 < 1/3.$$

The vector  $(h(x))_{x \geq 4}$  is then constructed as follows. Let  $(h(x))_{4 \leq x \leq 30}$  be an eigenvector associated with the largest eigenvalue  $\lambda_{\max}$  of  $\tilde{P}_3^{(30)}$ , such that  $\min_{4 \leq x \leq 30} h(x) = h(30) = 1$ . Note that the vector  $h$  can be chosen to have positive coordinates by the Perron-Frobenius theorem and it is easy to verify that  $x \rightarrow h(x)$  is decreasing. For  $x \geq 31$  we then let

$$h(x) = 13^{x-30} \left( \frac{30!}{x!} \right)^2.$$



We now verify that this vector satisfies (8.17) with  $\lambda$  slightly greater than  $\lambda_{\max}$ . Suppose first that  $y \in \{4, \dots, 30\}$ . In this case  $\sum_{4 \leq x \leq 30} h(x) \tilde{P}_3(x, y)$  equals  $\lambda_{\max} h(y)$  by definition, whereas the contribution of  $\sum_{x \geq 31} h(x) \tilde{P}_3(x, y)$  is less than  $\sum_{x \geq 31} h(x) < 0.014$ , thus

$$h \cdot \tilde{P}_3(y) \leq 0.263h(y). \tag{8.18}$$

Now, if  $y \geq 31$  we have

$$\begin{aligned} & \sum_{x \geq y-1} h(x) \tilde{P}_3(x, y) \\ & \leq 13^{y-30} \left( 13^{-1} \tilde{P}_3(y-1, y) \left( \frac{30!}{(y-1)!} \right)^2 + \tilde{P}_3(y, y) \left( \frac{30!}{y!} \right)^2 + \sum_{x \geq y+1} 13^{x-y} \left( \frac{30!}{x!} \right)^2 \right) \\ & \leq 13^{y-30} \left( \frac{30!}{y!} \right)^2 \left( \frac{2}{13} \frac{y^2}{y(y+1)} + \frac{4}{(y+1)(y+2)} + \sum_{i \geq 1} 13^i \left( \frac{y!}{(y+i)!} \right)^2 \right) \\ & \leq 0.3 \cdot h(y) \end{aligned}$$

which proves (8.17).

OTHER CRITICAL CASES. The other critical cases are treated in the same way. We only provide the reader with the numerical values of the maximal eigenvalues of the truncated substochastic matrices that are very good approximations of the maximal eigenvalues of the infinite matrices,

$$\max\{\text{eigenvalues}(P_2(i, j))_{5 \leq i, j \leq 30}\} \simeq 0.433040861268365 < 1/2,$$

$$\max\{\text{eigenvalues}(P_4(i, j))_{3 \leq i, j \leq 30}\} \simeq 0.231280689028977 < 1/4.$$

□

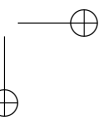
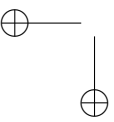
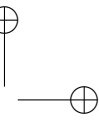
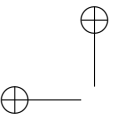

# Partial Match Queries in Two-Dimensional Quadtrees : A Probabilistic Approach.

---

LES RÉSULTATS DE CE CHAPITRE ONT ÉTÉ OBTENUS EN COLLABORATION AVEC ADRIEN JOSEPH ET ONT ÉTÉ ACCEPTÉS POUR PUBLICATION DANS *Advances in Applied Probability*.

We analyze the mean cost of the partial match queries in random two-dimensional quadtrees. The method is based on fragmentation theory. The convergence is guaranteed by a coupling argument of Markov chains, whereas the value of the limit is computed as the fixed point of an integral equation.

## 9.1 Introduction

Introduced by Finkel and Bentley [66], the quadtree structure is a comparison based algorithm designed for retrieving multidimensional data. It is often studied in computer science because of its numerous applications. The aim of this paper is to study the mean cost of the so-called *partial match queries* in random quadtrees. This problem was first analyzed by Flajolet *et al.* [67].

Let us briefly describe the discrete model. We choose to focus only on the two-dimensional case. Let  $P_1, \dots, P_n$  be  $n$  independent random variables uniformly distributed over  $(0, 1)^2$ . We shall assume that the points have different  $x$  and  $y$  coordinates, an event that has probability 1. We construct iteratively a finite covering of  $[0, 1]^2$  composed of rectangles with disjoint interiors as follows. The first point  $P_1$  divides the original square  $[0, 1]^2$  into four closed quadrants according to the vertical and horizontal positions of  $P_1$ . By induction, a point  $P_k$  divides the quadrant in which it falls into four quadrants according to its position in this quadrant, see Fig. 1. Hence the  $n$  points  $P_1, \dots, P_n$  give rise to a covering of  $[0, 1]^2$  into  $3n + 1$  closed rectangles with disjoint interiors that we denote by  $\text{Quad}(P_1, \dots, P_n)$ .

We are interested in the partial match query. As explained by Flajolet and Sedgewick [69, Example VII.23.], given  $x_0 \in [0, 1]$ , it determines the set of points  $P_i, i \in \{1, \dots, n\}$ , with  $x$  coordinates equal to  $x_0$ , regardless of the  $y$  coordinates (that set is either empty or a singleton). Denoting the vertical segment  $[(x, 0), (x, 1)]$  by  $S_x$ , the cost of this partial match query is measured by the number  $\mathcal{N}_n(x)$  of rectangles of  $\text{Quad}(P_1, \dots, P_n)$  intersecting  $S_x$  minus 1 ( $\mathcal{N}_0(x) = 0$  by convention). We shall study the cost of a *fixed* query. Our main result is :

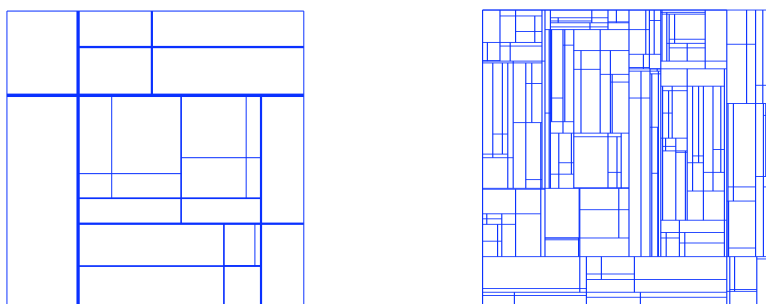

FIGURE 9.1 – Two splittings of  $[0, 1]^2$  with resp. 8 and 100 points.

**Theorem 9.1.** *For every  $x \in [0, 1]$ , we have the following convergence :*

$$n^{-\beta^*} \mathbb{E}[\mathcal{N}_n(x)] \xrightarrow[n \rightarrow \infty]{} K_0(x(1-x))^{\beta^*/2},$$

where  $\beta^* = \frac{\sqrt{17} - 3}{2}$  and  $K_0 = \frac{\Gamma(2\beta^* + 2)\Gamma(\beta^* + 2)}{2\Gamma^3(\beta^* + 1)\Gamma^2(\frac{\beta^*}{2} + 1)}$ .

Flajolet *et al.* [67] proved the convergence in mean of the properly rescaled cost of partial match queries when  $x$  is *random* with the uniform law on  $[0, 1]$  and independent of  $P_1, \dots, P_n$ . See also Chern and Hwang [44] for a more precise asymptotic behavior. We shall give another proof of this result using *fragmentation theory* (see Corollary 9.6 below). As a by-product of our techniques, we shall also prove in Corollary 9.9 below that, when rescaled by  $n^{1-\sqrt{2}}$ ,  $\mathcal{N}_n(0)$  converges in  $\mathbb{L}^2$  (its convergence in mean was obtained in [67]).

The paper is organized as follows. Section 9.2 introduces the model embedded in continuous-time and presents the first properties. Section 9.3 is devoted to the link between quadtrees and fragmentation theory. Section 9.4, the most technical one, contains the proof of the convergence at a fixed point  $x$  without knowing the limit. The identification of the limit is done in Section 9.5 using a fixed point argument for integral equation.

**Acknowledgement.** We would like to express our gratitude to Philippe Flajolet who introduced us to the problem of partial match query. We are indebted to Nicolas Broutin and to Ralph Neininger for fruitful discussions. We also deeply thank Jean Bertoin for his careful reading of the first versions of this work.

## 9.2 Notation and first properties

In order to apply probabilistic techniques, we first introduce a continuous-time version of the quadtree : the points  $P_1, \dots, P_n$  are replaced by the arrival points of a Poisson point process over  $\mathbb{R}_+ \times [0, 1]^2$  with intensity  $dt \otimes dx dy$ . All the results obtained in this model can easily be translated into results for the discrete-time model.

### 9.2.1 The continuous-time model

Let  $\Pi$  be a Poisson point process on  $\mathbb{R}_+ \times [0, 1]^2$  with intensity  $dt \otimes dx dy$ . Let  $((\tau_i, x_i, y_i), i \geq 1)$  be the atoms of  $\Pi$  ranked in the increasing order of their  $\tau$ -component. We define a process  $(Q(t))_{t \geq 0}$  with values in finite covering of  $[0, 1]^2$  by closed rectangles with disjoint interiors as follows. We first introduce the operation **SPLIT** : for every subset  $R$  of  $[0, 1]^2$  and for every  $(x, y) \in [0, 1]^2$ ,

$$\mathbf{SPLIT}(R, x, y) = \{R \cap [0, x] \times [0, y], R \cap [0, x] \times [y, 1], R \cap [x, 1] \times [0, y], R \cap [x, 1] \times [y, 1]\}.$$

In other words, if  $R$  is a rectangle with sides parallel to the  $x$  and  $y$  axes, then  $\mathbf{SPLIT}(R, x, y)$  is the set of the four quadrants in  $R$  determined by the point  $(x, y)$ . We may now recursively define the process  $(Q(t))_{t \geq 0}$ . Let  $\tau_0 = 0$ . For every  $t \in [0, \tau_1)$ , define  $Q(t) = \{[0, 1]^2\}$ , and for every  $t \in [\tau_i, \tau_{i+1})$ , denoting by  $R$  the only element (if any) of  $Q(\tau_{i-1})$  such that  $(x_i, y_i)$  is in the interior of the rectangle  $R$ , let

$$Q(t) = \mathbf{SPLIT}(R, x_i, y_i) \cup Q(\tau_{i-1}) \setminus \{R\}.$$

Observe that a.s., for every  $i \in \mathbb{Z}_+$ , there indeed exists a unique rectangle of  $Q(\tau_i)$  such that  $(x_{i+1}, y_{i+1})$  is in its interior, hence the process  $(Q(t))_{t \geq 0}$  is well defined up to an event of zero probability. In the sequel we shall assume that the points of  $\Pi$  always fall in the interior of some rectangle of  $(Q(t))_{t \geq 0}$ . As explained in the introduction, we are interested in the number of rectangles of  $Q(t)$  intersecting the segment  $S_x$ , specifically we set :

$$N_t(x) = \#\{R \in Q(t) : R \cap S_x \neq \emptyset\} - 1,$$

so that  $N_t(x) = 0$  for every  $0 \leq t < \tau_1$ . Recalling that  $\tau_n$  is the arrival time of the  $n$ -th point of  $\Pi$ ,  $Q(\tau_n)$  has the same distribution as the random variable  $\text{Quad}(P_1, \dots, P_n)$  of the introduction. In particular, for every  $(n, x) \in \mathbb{N} \times [0, 1]$ , we have  $N_{\tau_n}(x) = \mathcal{N}_n(x)$  in distribution.

### 9.2.2 Main equations

Let  $x \in [0, 1]$ . We denote by  $\mathcal{A}$  the set of words over the alphabet  $\{0, 1\}$ ,

$$\mathcal{A} = \bigcup_{n \geq 0} \{0, 1\}^n,$$

where by convention  $\{0, 1\}^0 = \{\emptyset\}$ . Thus, if  $u \in \mathcal{A}$ ,  $u$  is either  $\emptyset$  or a finite sequence of 0 and 1. If  $u$  and  $v$  are elements of  $\mathcal{A}$  then  $uv$  denotes the concatenation of the two words  $u$  and  $v$ . We label the rectangles appearing in  $(Q(t))_{t \geq 0}$  whose intersection with the segment  $S_x$  is non-empty by elements of  $\mathcal{A}$  according to the following rule. By convention  $R_\emptyset(x)$  is the unit square  $[0, 1]^2$ . The first point  $(\tau_1, x_1, y_1)$  of  $\Pi$  splits  $[0, 1]^2$  into four rectangles, a.s. only two of them intersect  $S_x$ , we denote the bottom rectangle by  $R_0(x)$  and the top one by  $R_1(x)$ . Inductively, for every  $u \in \mathcal{A}$ , a point of  $\Pi$  eventually falls into  $R_u(x)$ , dividing it into four rectangles. Almost surely, only two of them intersect  $S_x$ , denote the bottom one by  $R_{u0}(x)$  and the top one by  $R_{u1}(x)$ .

For  $u \in \mathcal{A}$ , we denote the minimal (resp. maximal) horizontal coordinate of  $R_u(x)$  by  $G_u(x)$  (resp.  $D_u(x)$ ), and define the *place* of  $x$  in  $R_u(x)$  to be

$$X_u(x) = \frac{x - G_u(x)}{D_u(x) - G_u(x)}.$$

If  $u \neq \emptyset$ , we denote the parent of  $u$  by  $\overleftarrow{u}$  which is the word  $u$  without its last letter. We write  $M_u(x)$  for the ratio of the (two-dimensional) Lebesgue measure  $\text{Leb}(R_u(x))$  of  $R_u(x)$  by the measure of  $R_{\overleftarrow{u}}(x)$ ,

$$M_u(x) = \frac{\text{Leb}(R_u(x))}{\text{Leb}(R_{\overleftarrow{u}}(x))}.$$

We also set for all  $x \in [0, 1]$ ,  $M_\emptyset(x) = 1$ . For  $u \in \{0, 1\}$  and  $t \geq 0$ , we introduce the “subquadtrees”  $Q_{u,x}(t) = \{R \in \mathcal{Q}(t + \tau_1) : R \subset R_u(x)\}$ . Then, for every  $t \geq 0$ , one has :

$$N_t(x) = \mathbf{1}_{t \geq \tau_1} + \mathbf{1}_{t \geq \tau_1} \sum_{u \in \{0,1\}} \left( \#\{R \in Q_{u,x}(t - \tau_1) : R \cap S_x \neq \emptyset\} - 1 \right). \quad (9.1)$$

If  $R$  is a rectangle with sides parallel to the  $x$  and  $y$  axes, we denote by  $\Phi_R : \mathbb{R}^2 \rightarrow \mathbb{R}^2$  the only affine transformation that maps the bottom left vertex of  $R$  to  $(0, 0)$ , the bottom right vertex of  $R$  to  $(1, 0)$  and the up left vertex of  $R$  to  $(0, 1)$ . It should be plain from properties of Poisson point measures that, conditionally on  $(M_u(x), X_u(x), R_u(x))$ , the process  $(\Phi_{R_u(x)}(Q_{u,x}(t)))_{t \geq 0}$  has the same distribution as the process  $(\tilde{Q}(M_u(x)t))_{t \geq 0}$ , where  $\tilde{Q}$  is an independent copy of  $Q$ . In particular, conditionally on  $(M_u(x), X_u(x))$ , the number of rectangles in  $Q_{u,x}$  that intersect  $S_x$  (minus 1), viewed as a process of  $t$ , has the same distribution as the process  $(\tilde{N}_{M_u(x)t}(X_u(x)))_{t \geq 0}$  where  $\tilde{N}$  is defined from  $\tilde{Q}$  is the same way as  $N$  is defined from  $Q$ . Since  $M_0(x)$  and  $M_1(x)$  have the same distribution, (9.1) yields

$$\mathbb{E}[N_t(x)] = \mathbb{P}(t \geq \tau_1) + 2\mathbb{E}\left[\tilde{N}_{M_0(x)(t-\tau_1)}(X_0(x))\right], \quad (9.2)$$

with the convention  $\tilde{N}_t(x) = 0$  whenever  $t < 0$ . More generally, if we write  $\mathfrak{z}_k \in \mathcal{A}$  for  $\mathfrak{z}_k = 0 \dots 0$  repeated  $k$  times, then for every positive integer  $k$ ,

$$\mathbb{E}[N_t(x)] = g_k(t) + 2^k \mathbb{E}\left[\tilde{N}_{M_{\mathfrak{z}_1}(x) \dots M_{\mathfrak{z}_k}(x)t - F_k}(X_{\mathfrak{z}_k}(x))\right], \quad (9.3)$$

where  $g_k$  is a function such that  $0 \leq g_k \leq 2^k - 1$  and  $F_k$  is a nonnegative random variable defined by

$$F_k = \sum_{i=1}^k \tilde{\tau}_i \prod_{j=i}^k M_{\mathfrak{z}_j}(x),$$

with  $(\tilde{\tau}_i)_{i \geq 1}$  a sequence of independent exponential variables with parameter 1.

We now compute the joint distribution of  $(M_0(x), X_0(x))$  which will be of great use throughout this work. If  $f$  is a nonnegative measurable function, easy calculations yield

$$\begin{aligned} \mathbb{E}\left[f(M_0(x), X_0(x))\right] &= \int_0^1 du \int_0^1 dv \left( \mathbf{1}_{x < u} f\left(uv, \frac{x}{u}\right) + \mathbf{1}_{x > u} f\left((1-u)v, \frac{x-u}{1-u}\right) \right) \\ &= \int_x^1 \frac{dy}{y} \int_0^{\frac{x}{y}} dm f(m, y) + \int_0^x \frac{dy}{1-y} \int_0^{\frac{1-x}{1-y}} dm f(m, y) \quad (9.4) \\ &= \int_0^x dm \int_x^1 \frac{dy}{y} f(m, y) + \int_x^1 dm \int_x^{\frac{x}{m}} \frac{dy}{y} f(m, y) \\ &+ \int_0^{1-x} dm \int_0^x \frac{dy}{1-y} f(m, y) + \int_{1-x}^1 dm \int_{1-\frac{1-x}{m}}^x \frac{dy}{1-y} f(m, y) \quad (9.5) \end{aligned}$$

### 9.2.3 Depoissonization

The following lemma contains a large deviations argument that will enable us to shift results from the continuous-time model to the discrete-time one.

**Lemma 9.2.** *For every  $\varepsilon > 0$ , we have*

$$\mathbb{E} \left[ \sup_{x \in [0,1]} |N_{\tau_n}(x) - N_n(x)|^2 \mathbf{1}_{\tau_n \notin [n(1-\varepsilon), n(1+\varepsilon)]} \right] \xrightarrow{n \rightarrow \infty} 0.$$

*Démonstration.* Note that for every  $x \in [0, 1]$ ,  $t \mapsto N_t(x)$  is non-decreasing and that  $N_t(x)$  is at most the number of points fallen so far :  $N_t(x) \leq \max \{i \in \mathbb{Z}_+ : \tau_i \leq t\}$ . In particular  $N_{\tau_n}(x) \leq n$ , thus we have

$$\sup_{x \in [0,1]} |N_{\tau_n}(x) - N_n(x)|^2 \mathbf{1}_{\tau_n > n(1+\varepsilon)} \leq n^2 \mathbf{1}_{\tau_n > n(1+\varepsilon)}.$$

A large deviations argument ensures that  $n^2 \mathbb{P}(\tau_n > n(1+\varepsilon))$  tends to 0 as  $n \rightarrow \infty$ . On the other hand, applying the Cauchy-Schwarz inequality, we obtain

$$\mathbb{E} \left[ \sup_{x \in [0,1]} |N_{\tau_n}(x) - N_n(x)|^2 \mathbf{1}_{\tau_n < n(1-\varepsilon)} \right] \leq \sqrt{\mathbb{E}[(\max \{i \in \mathbb{Z}_+ : \tau_i \leq n\})^4]} \sqrt{\mathbb{P}(\tau_n < n(1-\varepsilon))}.$$

As  $\mathbb{E}[(\max \{i \in \mathbb{Z}_+ : \tau_i \leq n\})^4] = O(n^4)$ , large deviations ensure that the quantity in the right-hand side tends to 0 as  $n \rightarrow \infty$ . Finally, Lemma 9.2 is proved.  $\square$

## 9.3 Particular cases and fragmentation theory

We give below the definition of a particular case of fragmentation process. For more details, we refer to [24]. Let  $\nu$  be a probability measure on  $\{(s_1, s_2) : s_1 \geq s_2 > 0 \text{ and } s_1 + s_2 \leq 1\}$ . A self-similar fragmentation  $(\mathcal{F}_t)_{t \geq 0}$  with dislocation measure  $\nu$  and index of self-similarity 1 is a Markov process with values in the set  $\mathcal{S}^\downarrow = \{(s_1, s_2, \dots) : s_1 \geq s_2 \geq \dots \geq 0 \text{ and } \sum_i s_i \leq 1\}$  describing the evolution of the masses of particles that undergo fragmentation. The process is informally characterized as follows : if at

time  $t$  we have  $\mathcal{F}(t) = (s_1(t), s_2(t), \dots)$ , then for every  $i \geq 1$ , the  $i$ -th “particle” of mass  $s_i(t)$  lives an exponential time with parameter  $s_i(t)$  before splitting into two particles of masses  $r_1 s_i(t)$  and  $r_2 s_i(t)$ , where  $(r_1, r_2)$  has been sampled from  $\nu$  independently of the past and of the other particles. In other words, each particle undergoes a self-similar fragmentation with time rescaled by its mass. In the next section we establish a link between fragmentation theory and the process  $N_t(U)$ , where  $U$  is a r.v. uniformly distributed over  $[0, 1]$  and independent of  $(Q(t))_{t \geq 0}$ . This connection will provide a new proof of a result of [67] and [44]. See also [47] for another recent application of fragmentation theory to a combinatorial problem where the exponent  $\frac{\sqrt{17}-3}{2}$  appears.

### 9.3.1 The uniform case

We consider here the case where the point  $x$  is chosen at random uniformly over  $[0, 1]$  and independently of  $(Q(t))_{t \geq 0}$ .

**Proposition 9.3.** *Let  $U$  be a random variable uniformly distributed over  $[0, 1]$  and independent of the quadtree  $(Q(t))_{t \geq 0}$ . Let  $u \in \mathcal{A}$  and denote by  $u_0 = \emptyset, u_1, \dots, u_k = u$  its ancestors. Then  $X_u(U)$  is uniform over  $[0, 1]$  and independent of  $(M_{u_1}(U), \dots, M_{u_k}(U))$ , which is a sequence of independent random variables all having density  $2(1-m)\mathbf{1}_{m \in [0,1]}$ .*

*Démonstration.* We prove Proposition 9.3 by induction on  $k$ . Let  $u \in \mathcal{A}$ . Denote by  $u_0 = \emptyset, u_1, \dots, u_k = u$  its ancestors. Integrating (9.4) for  $x \in [0, 1]$ , we deduce that for every  $v \in \{0, 1\}$ ,  $X_v(U)$  and  $M_v(U)$  are independent and distributed according to

$$\mathbf{1}_{u \in [0,1]} du \otimes \mathbf{1}_{m \in [0,1]} 2(1-m) dm. \tag{9.6}$$

Recalling that  $Q_{u_1, U}(t) = \{R \in Q(t+\tau_1) : R \subset R_{u_1}(U)\}$ , conditionally on  $(X_{u_1}(U), M_{u_1}(U))$ , the process  $\Phi_{R_{u_1}(U)}(Q_{u_1, U})$  has the same distribution as  $(\tilde{Q}(M_{u_1}(U)t))_{t \geq 0}$ , where  $\tilde{Q}$  is an independent copy of  $Q$ . Since  $X_{u_1}(U)$  is uniform over  $[0, 1]$ , we deduce by induction on the subquadtree  $Q_{u_1, U}$  that  $X_u(U)$  is uniform over  $[0, 1]$  and independent of  $(M_{u_2}(U), \dots, M_{u_k}(U))$  which is a sequence of independent r.v. all having density  $2(1-m)\mathbf{1}_{m \in [0,1]}$ . Furthermore it is easy to see that

$$\mathbb{E}[(X_{u_i}(U), M_{u_i}(U))_{2 \leq i \leq k} | (X_{u_1}(U), M_{u_1}(U))] = \mathbb{E}[(X_{u_i}(U), M_{u_i}(U))_{2 \leq i \leq k} | X_{u_1}(U)].$$

Hence by (9.6),  $X_u(U)$  is also independent of  $M_{u_1}(U)$ . □

Letting  $\mathbf{m}(t) = \mathbb{E}[N_t(U)]$ , (recall that when  $t < 0$ ,  $N_t(x) = 0$  for all  $x \in [0, 1]$ ) equation (9.2) becomes

$$\mathbf{m}(t) = \mathbb{P}(t \geq \tau_1) + 2\mathbb{E}[\mathbf{m}(M(t - \tau_1))], \tag{9.7}$$

where  $M$  is independent of  $\tau_1$  and has density  $2(1-m)\mathbf{1}_{m \in [0,1]}$ .

**Proposition 9.4.** *Let  $U$  be uniform over  $[0, 1]$  and independent of  $(Q(t))_{t \geq 0}$ . We have the following convergence*

$$\lim_{t \rightarrow \infty} t^{-\beta^*} \mathbb{E}[N_t(U)] = \frac{\Gamma(2(\beta^* + 1))}{2\Gamma^3(\beta^* + 1)}, \quad \text{where } \beta^* = \frac{\sqrt{17}-3}{2}.$$



*Démonstration.* We consider an auxiliary fragmentation process  $(\mathcal{F}_t)_{t \geq 0}$  with index of self-similarity 1 and dislocation probability measure  $\nu$  given by

$$\int \nu(ds_1, ds_2) f(s_1, s_2) = \mathbb{E} \left[ f(M_1(U) \vee M_0(U), M_1(U) \wedge M_0(U)) \right].$$

In other words, the dislocation measure is given by the law of the decreasing ordering of  $\{M_0(U), M_1(U)\}$ . More precisely  $(\mathcal{F}_t)_{t \geq 0}$  takes its values in  $\mathcal{S}^\downarrow$  and satisfies the following equation in distribution which completely characterizes its law :

$$(\mathcal{F}_t) \stackrel{(d)}{=} \left( (\mathbf{1}_{t < \tau}) \dot{+} (\mathbf{1}_{t \geq \tau} M_0(U) \cdot \mathcal{F}_{M_0(U)(t-\tau)}^{(0)})_{t \geq 0} \dot{+} (\mathbf{1}_{t \geq \tau} M_1(U) \cdot \mathcal{F}_{M_1(U)(t-\tau)}^{(1)})_{t \geq 0} \right)^\downarrow,$$

with  $(\mathcal{F}_t^{(0)})_{t \geq 0}$  and  $(\mathcal{F}_t^{(1)})_{t \geq 0}$  two independent copies of  $(\mathcal{F}_t)_{t \geq 0}$  also independent of  $(M_0(U), M_1(U), \tau)$  and  $\tau$  an independent exponential variable with parameter 1. The symbol  $\dot{+}$  means concatenation of sequences and  $(\cdot)^\downarrow$  is the decreasing reordering (and erasing of zeros). Then, it is straightforward to see that the expectation of the number  $\#\mathcal{F}_t$  of fragments of  $\mathcal{F}_t$  minus 1 satisfies the same equation as  $\mathbb{E}[N_t(U)]$ , namely letting  $\mathbf{m}(t) = \mathbb{E}[\#\mathcal{F}_t - 1]$  for  $t \geq 0$ , and  $\mathbf{m}(t) = 0$  for  $t < 0$  we have

$$\mathbf{m}(t) = \mathbb{P}(t \geq \tau_1) + 2\mathbb{E}[\mathbf{m}(M(t - \tau_1))], \tag{9.8}$$

where  $M$  is independent of  $\tau_1$  and has density  $2(1 - m)\mathbf{1}_{m \in [0,1]}$ . By (9.7) and (9.8), the functions  $\mathbf{m}$  and  $\mathbf{m}$  satisfy the same integral equation,

$$f(t) = 1 - e^{-t} + 2 \int_0^1 dm 2(1 - m) \int_0^t ds e^{-s} f(m(t - s)).$$

Differentiating with respect to  $t$ , we see that both  $\mathbf{m}$  and  $\mathbf{m}$  are solutions of the Cauchy problem for the integro-differential equation

$$\begin{cases} \partial_t f(t) = 1 - f(t) + \int_0^1 dm 2(1 - m) f(mt), \\ f(0) = 0. \end{cases}$$

Uniqueness of solution of this kind of integro-differential equation is known, see *e.g.* [78]. We deduce that for every  $t \geq 0$ ,  $\mathbf{m}(t) = \mathbf{m}(t)$ . We now focus on  $\mathbf{m}(t)$ . Following [25, Section 3], we let for every  $\beta > 0$ ,  $\psi(\beta) = 1 - \int \nu(ds_1, ds_2)(s_1^\beta + s_2^\beta)$ . An easy calculation yields :

$$\psi(\beta) = \frac{\beta^2 + 3\beta - 2}{(\beta + 1)(\beta + 2)}.$$

In particular the Malthusian exponent associated to  $\nu$ , which is characterized by  $\psi(\beta) = 0$  (see [24, Section 1.2.2]), is

$$\beta^* = \frac{\sqrt{17} - 3}{2}.$$

Applying [25, Theorem 1], we get :

$$\lim_{t \rightarrow \infty} t^{-\beta^*} \mathbb{E}[\#\mathcal{F}_t] = \frac{\Gamma(1 - \beta^*)}{\beta^*} \frac{4}{2\beta^* + 3} \prod_{k=1}^{\infty} \left(1 - \frac{\beta^*}{k}\right) \left(1 - \frac{\beta^*}{k + \sqrt{17}}\right) \left(1 + \frac{\beta^*}{k + 1}\right) \left(1 + \frac{\beta^*}{k + 2}\right).$$

Finally, we use the Weierstrass identity for the gamma function : for every complex number  $z \in \mathbb{C} \setminus \mathbb{Z}_-$ ,

$$\Gamma(z + 1) = e^{-\gamma z} \prod_{k=1}^{\infty} \left(1 + \frac{z}{k}\right)^{-1} e^{z/k},$$

where  $\gamma$  is the Euler–Mascheroni constant. We conclude that

$$\lim_{t \rightarrow \infty} t^{-\beta^*} \mathbb{E}[N_t(U)] = \frac{4}{\beta^*(2\beta^* + 3)} \frac{\Gamma(\sqrt{17} + 1)}{\Gamma(\sqrt{17} - \beta^* + 1)} \frac{1}{\Gamma^2(\beta^* + 2)} \frac{1}{1 + \beta^*/2} = \frac{\Gamma(2(\beta^* + 1))}{2\Gamma^3(\beta^* + 1)},$$

which completes the proof of the proposition.  $\square$

**Remark 9.5.** One can derive the following equality in distribution from (9.1) :

$$N_t(U) \stackrel{(d)}{=} \mathbf{1}_{\tau_1 \leq t} + N_{M_0(U)(t-\tau_1)}^{(0)}(X_0(U)) + N_{M_1(U)(t-\tau_1)}^{(1)}(X_1(U)),$$

where  $(N_t^{(0)})_{t \geq 0}$  and  $(N_t^{(1)})_{t \geq 0}$  are independent copies of the process  $(N_t)_{t \geq 0}$ . We have already noticed that  $X_0(U)$  and  $X_1(U)$  are also uniform and independent of  $(N_t^{(0)})_{t \geq 0}$ , of  $(N_t^{(1)})_{t \geq 0}$  and of  $(M_0(U), M_1(U))$ . If  $X_0(U)$  and  $X_1(U)$  were independent, then  $N_t(U)$  would satisfy the same distributional equation as  $(\#\mathcal{F}_t - 1)_{t \geq 0}$ . However, this is not the case since we have  $X_0(U) = X_1(U)$ . This explains why we had to work with expectations.

**Corollary 9.6** ([67], [44]). We have

$$\lim_{n \rightarrow \infty} n^{-\beta^*} \mathbb{E}[\mathcal{N}_n(U)] = \frac{\Gamma(2(\beta^* + 1))}{2\Gamma^3(\beta^* + 1)}.$$

*Démonstration.* This is a straightforward application of Lemma 9.2 and Proposition 9.4.  $\square$

**Remark 9.7.** Observe that Chern and Hwang [44] obtained a more precise asymptotic behavior of  $\mathbb{E}[\mathcal{N}_n(U)]$ . They proved that

$$\mathbb{E}[\mathcal{N}_n(U)] = \frac{\Gamma(2(\beta^* + 1))}{2\Gamma^3(\beta^* + 1)} n^{\beta^*} + O(1).$$

### 9.3.2 Case $x = 0$

As a further example of the connection with fragmentation theory, we derive asymptotics properties for  $N_t(0)$ . In this case, the sequence of the areas of the rectangles crossed by  $S_0$  is a fragmentation process, enabling us to state a convergence of  $N_t(0)$ , once rescaled, in  $\mathbb{L}^2$ . A convergence in mean has already been obtained in [67, Theorem 6] and [68].

**Theorem 9.8.** *The random variable*

$$\mathfrak{M}_t = \sum_{u \in \mathcal{A}} \text{Leb}(R_u(0))^{\sqrt{2}-1} \mathbf{1}_{R_u(0) \in \mathcal{Q}(t)}, \quad t \geq 0,$$

is a uniformly integrable martingale which converges almost surely to  $\mathfrak{M}_\infty$  as  $t \rightarrow \infty$ . The distribution of  $\mathfrak{M}_\infty$  is characterized by

$$\mathbb{E}[\mathfrak{M}_\infty] = 1 \quad \text{and} \quad \mathfrak{M}_\infty \stackrel{(d)}{=} M_0(0)^{\sqrt{2}-1} \mathfrak{M}_\infty^{(0)} + M_1(0)^{\sqrt{2}-1} \mathfrak{M}_\infty^{(1)}, \quad (9.9)$$

where  $\mathfrak{M}_\infty^{(0)}$  and  $\mathfrak{M}_\infty^{(1)}$  are two independent copies of  $\mathfrak{M}_\infty$  also independent of  $(M_0(0), M_1(0))$ . Furthermore, we have the following convergence in  $\mathbb{L}^2$  :

$$t^{1-\sqrt{2}} N_t(0) \xrightarrow{t \rightarrow \infty} \frac{\Gamma(2\sqrt{2})}{\sqrt{2}\Gamma^3(\sqrt{2})} \mathfrak{M}_\infty.$$

*Démonstration.* It is easy to check from properties of Poisson measures that the rearrangement in decreasing order of the masses of the rectangles living at time  $t$  and intersecting  $S_0$ ,

$$\left( \text{Leb}(R_u(0)) \mathbf{1}_{R_u(0) \in Q(t)} \right)_{t \geq 0}^\downarrow,$$

is a self-similar fragmentation with index 1 and dislocation probability measure given by the decreasing ordering of  $\{M_0(0), M_1(0)\}$ . As in the proof of Proposition 9.4, we introduce for every  $\beta > 0$ ,  $\Psi(\beta) = 1 - \mathbb{E}[M_0(0)^\beta + M_1(0)^\beta]$ , which is easily computed :

$$\Psi(\beta) = \frac{(\beta + 1)^2 - 2}{(\beta + 1)^2}.$$

Thus the Malthusian exponent  $p^*$  of this fragmentation satisfying  $\Psi(p^*) = 0$  is

$$p^* = \sqrt{2} - 1.$$

The first two points of the theorem follow from classical results of fragmentation theory, see [24, Theorem 1.1]. We refer to [104] for the characterization of the law of  $\mathfrak{M}_\infty$  via the distributional equation (9.9) and to [105] for some of its properties. The last point comes from [25, Corollary 6] and the Weierstrass identity for the gamma function used in a similar manner as in the proof of Proposition 9.4.  $\square$

**Corollary 9.9.** *We have the following convergence in  $\mathbb{L}^2$  :*

$$n^{1-\sqrt{2}} N_{\tau_n}(0) \xrightarrow{n \rightarrow \infty} \frac{\Gamma(2\sqrt{2})}{\sqrt{2}\Gamma^3(\sqrt{2})} \mathfrak{M}_\infty.$$

*Démonstration.* This proposition easily derives from Lemma 9.2 and Theorem 9.8.  $\square$

**Remark 9.10.** Observe that Corollary 9.9 implies the following convergence in distribution :

$$n^{1-\sqrt{2}} \mathcal{N}_n(0) \xrightarrow{n \rightarrow \infty} \frac{\Gamma(2\sqrt{2})}{\sqrt{2}\Gamma^3(\sqrt{2})} \mathfrak{M}_\infty.$$

**Remark 9.11.** It is worthwhile to notice that the behavior of the cost of the partial match query in the case  $x = 0$  is drastically different from its behavior in the case when  $x$  is uniform or  $x$  is fixed in  $(0, 1)$  (see Theorem 9.1 and Proposition 9.4).

### 9.3.3 An *a priori* uniform bound

This section is devoted to the proof of an *a priori* uniform bound on  $s^{-\beta^*} \mathbb{E}[N_s(x)]$  over  $(x, s) \in (0, 1) \times (0, \infty)$  that will be useful in many places.

**Lemma 9.12.** *There exists  $C < \infty$  such that*

$$\sup_{x \in (0,1)} \sup_{s > 0} \mathbb{E} \left[ s^{-\beta^*} N_s(x) \right] \leq C. \quad (9.10)$$

*Démonstration.* As a warmup, we start by proving that there exists  $C_1 < \infty$  such that for every  $x \in (0, 1)$ ,

$$\sup_{s > 0} \mathbb{E} \left[ s^{-\beta^*} N_s(x) \right] \leq \frac{C_1}{x \wedge (1-x)}. \quad (9.11)$$

Combining (9.2) with the densities computed in (9.4), we deduce that for every  $x \in (0, 1)$

$$\begin{aligned} t^{-\beta^*} \mathbb{E}[N_t(x)] &= t^{-\beta^*} \mathbb{P}(t \geq \tau_1) + 2 \left( \int_x^1 \frac{dy}{y} \int_0^{\frac{x}{y}} dm \mathbb{E} \left[ t^{-\beta^*} N_{m(t-\tau_1)}(y) \right] \right. \\ &\quad \left. + \int_0^x \frac{dy}{1-y} \int_0^{\frac{1-x}{1-y}} dm \mathbb{E} \left[ t^{-\beta^*} N_{m(t-\tau_1)}(y) \right] \right). \end{aligned} \quad (9.12)$$

By monotony of  $t \mapsto N_t(x)$  we have  $\mathbb{E} \left[ t^{-\beta^*} N_{m(t-\tau_1)}(y) \right] \leq \mathbb{E} \left[ t^{-\beta^*} N_t(y) \right]$ . Furthermore, recalling that  $\beta^* < 1$ , there exists a constant  $C'$  such that for every  $t > 0$ ,  $t^{-\beta^*} \mathbb{P}(t \geq \tau_1) \leq C'$ . Hence

$$\begin{aligned} t^{-\beta^*} \mathbb{E}[N_t(x)] &\leq C' + 2 \left( \int_x^1 \frac{xdy}{y^2} \mathbb{E} \left[ t^{-\beta^*} N_t(y) \right] + \int_0^x \frac{(1-x)dy}{(1-y)^2} \mathbb{E} \left[ t^{-\beta^*} N_t(y) \right] \right) \\ &\leq C' + \frac{2}{x \wedge (1-x)} \int_0^1 dy \mathbb{E} \left[ t^{-\beta^*} N_t(y) \right] \\ &= C' + \frac{2}{x \wedge (1-x)} \mathbb{E} \left[ t^{-\beta^*} N_t(U) \right]. \end{aligned}$$

It has been shown in Proposition 9.4 that  $\mathbb{E} \left[ t^{-\beta^*} N_t(U) \right]$  has a finite limit as  $t \rightarrow \infty$ , and for every  $t > 0$ ,  $\mathbb{E}[N_t(U)] \leq t$ . Thus the quantity  $\mathbb{E} \left[ t^{-\beta^*} N_t(U) \right]$  is bounded over  $(0, \infty)$ . The inequality (9.11) follows from these considerations.

Introducing  $S(x) = \sup_{s > 0} s^{-\beta^*} \mathbb{E}[N_s(x)]$  for every  $x \in [0, 1]$ , we have just shown

that  $S(x) \leq C_1(x \wedge (1-x))^{-1}$ . Using (9.12), we have for every  $x \in (1/2, 1)$  :

$$\begin{aligned}
 S(x) &= \sup_{t>0} \left\{ t^{-\beta^*} \mathbb{P}(t \geq \tau_1) + 2 \left( \int_x^1 \frac{dy}{y} \int_0^{\frac{x}{y}} dm \mathbb{E} \left[ t^{-\beta^*} N_{m(t-\tau_1)}(y) \right] \right. \right. \\
 &\quad \left. \left. + \int_0^x \frac{dy}{1-y} \int_0^{\frac{1-x}{1-y}} dm \mathbb{E} \left[ t^{-\beta^*} N_{m(t-\tau_1)}(y) \right] \right) \right\} \\
 &\leq C' + 2 \sup_{t>0} \left\{ \int_x^1 \frac{dy}{y} \int_0^1 dm \mathbb{E} \left[ t^{-\beta^*} N_t(y) \right] + \int_0^{1/2} \frac{dy}{1-y} \int_0^1 dm \mathbb{E} \left[ t^{-\beta^*} N_t(y) \right] \right\} \\
 &\quad + 2 \sup_{t>0} \int_{1/2}^x \frac{dy}{1-y} \int_0^{\frac{1-x}{1-y}} dm m^{\beta^*} \mathbb{E} \left[ (mt)^{-\beta^*} N_{mt}(y) \right] \\
 &\leq C' + 8 \sup_{t>0} \int_0^1 dy \mathbb{E} \left[ t^{-\beta^*} N_t(y) \right] + 2 \int_{1/2}^x \frac{dy}{1-y} \int_0^{\frac{1-x}{1-y}} dm m^{\beta^*} S(y) \\
 &\leq C_2 + \frac{2}{\beta^* + 1} (1-x)^{\beta^*+1} \int_{1/2}^x dy \frac{1}{(1-y)^{\beta^*+2}} S(y). \tag{9.13}
 \end{aligned}$$

Let us show that this implies that for every  $x \in (0, 1)$ ,  $S(x) \leq 100C_2$ . Arguing by contradiction, suppose that there exists  $a \in (1/2, 1)$  such that  $S(a) > 100C_2$ . Let  $S = \sup_{x \in [1/2, a]} S(x)$ . By (9.11),  $S$  is finite; there exists  $b \in [1/2, a]$  such that  $S(b) \geq 0.9S$ . In particular,  $S(b) \geq 0.9 \sup_{x \in [1/2, b]} S(x)$  and  $S(b) > 90C_2$ . Applying (9.13) at  $b$ , we get

$$\begin{aligned}
 S(b) &\leq 90^{-1} S(b) + \frac{2}{\beta^* + 1} (1-b)^{\beta^*+1} \int_{1/2}^b dy \frac{1}{(1-y)^{\beta^*+2}} 0.9^{-1} S(b) \\
 &\leq 90^{-1} S(b) + \frac{2 \cdot 0.9^{-1}}{(\beta^* + 1)^2} S(b),
 \end{aligned}$$

leading to a contradiction since  $(\beta^* + 1)^2 > \frac{2 \cdot 0.9^{-1}}{1-90^{-1}}$ . Finally,  $S(x) \leq 100C_2$  for every  $x \in (0, 1)$ .  $\square$

## 9.4 The convergence at fixed $x \in (0, 1)$

We prove in this section that when  $x \in [0, 1]$  is fixed,  $t^{-\beta^*} \mathbb{E}[N_t(x)]$  admits a finite limit as  $t \rightarrow \infty$ . The results of the preceding section do not directly apply since the place  $X_0(x)$  of  $x$  in the rectangle  $R_0(x)$  highly depends on  $x$ . Recall notation  $\mathfrak{z}_k$  for the word composed of  $k$  zeros  $0 \dots 0 \in \mathcal{A}$ . The guiding idea is that the splittings tend to make  $X_{\mathfrak{z}_k}(x)$  uniform and independent of  $M_{\mathfrak{z}_k}(x)$ .

### 9.4.1 A key Markov chain

Fix  $x \in (0, 1)$ . To simplify notation, for every  $k \geq 1$ , we write  $X_k$  for  $X_{\mathfrak{z}_k}(x)$  and  $M_k$  for  $M_{\mathfrak{z}_k}(x)$ . We shall focus on the process  $(X_k, M_k)_{k \geq 0}$ , which is obviously a homogeneous Markov chain starting from  $(x, 1)$  whose transition probability is given by (9.4) or (9.5). Let  $k \geq 1$ . We denote by  $\mathcal{F}_k$  the filtration generated by  $(X_i, M_i)_{1 \leq i \leq k}$ . It is easy to see that the transition probability only depends on  $X_k$ , that is

$$\mathbb{E}[(X_{k+i}, M_{k+i})_{i \geq 1} | \mathcal{F}_k] = \mathbb{E}[(X_{k+i}, M_{k+i})_{i \geq 1} | X_k].$$

**Proposition 9.13.** *Fix  $x \in (0, 1)$ . There exists a coupling of the chain  $(X_k, M_k)_{k \geq 0}$  with a random time  $T \in \mathbb{Z}_+$  such that for any  $k \geq 0$ , conditionally on  $\{T \leq k\}$ , the r.v.  $X_k$  is uniformly distributed over  $[0, 1]$ , independent of  $(M_i)_{1 \leq i \leq k}$  and of  $T$ . Furthermore, we have*

$$\mathbb{E} [1.15^T] < +\infty.$$

*Démonstration.* For any  $k \geq 1$  we consider the event

$$E_k = \{M_k < X_{k-1} \wedge (1 - X_{k-1})\}.$$

Using the explicit densities (9.4) and (9.5), one sees that conditionally on  $\mathcal{F}_{k-1}$  and on the event  $E_k$  of probability  $-(X_{k-1} \wedge (1 - X_{k-1})) \ln(X_{k-1}(1 - X_{k-1}))$ , the conditional distribution of  $X_k$  is

$$\frac{1}{-\ln(X_{k-1}(1 - X_{k-1}))} \left( \frac{1}{1-y} \mathbf{1}_{y \in (0, X_{k-1})} + \frac{1}{y} \mathbf{1}_{y \in (X_{k-1}, 1)} \right) dy.$$

In particular, conditionally on  $E_k$  and  $\mathcal{F}_{k-1}$ , the variable  $X_k$  is independent of  $M_k$  and has a density bounded from below by  $-1/\ln(X_{k-1}(1 - X_{k-1}))$ . Thus, we can construct simultaneously with  $(X_k, M_k)_{k \geq 0}$  a sequence of random variables  $(B_k)_{k \geq 0} \in \{0, 1\}^{\mathbb{Z}_+}$  as follows. Suppose that we have constructed  $(X_i, M_i, B_i)_{0 \leq i \leq k-1}$ . Then independently of  $\mathcal{F}_{k-1}$ , toss a Bernoulli variable of parameter  $-(X_{k-1} \wedge (1 - X_{k-1})) \ln(X_{k-1}(1 - X_{k-1}))$ . If 0 comes out, we consider that we are on the event  $E_k^c$ , then put  $B_k = 0$  and sample  $(X_k, M_k)$  with the conditional distribution on  $E_k^c$  and  $\mathcal{F}_{k-1}$ . If 1 comes out, we consider that we are on the event  $E_k$  and we proceed to the following.

1. First sample  $M_k$  from its distribution conditionally on  $E_k$  and  $\mathcal{F}_{k-1}$ .
2. Then independently of  $M_k$ , toss a Bernoulli variable  $B_k$  of parameter  $-1/\ln(X_{k-1}(1 - X_{k-1}))$ . If  $B_k = 1$ , sample  $X_k$  uniformly from  $[0, 1]$  and independently of  $(M_1, \dots, M_k)$ . Otherwise, sample  $X_k$  with density

$$\frac{1}{-\ln(X_{k-1}(1 - X_{k-1})) - 1} \left( \left( \frac{1}{1-y} - 1 \right) \mathbf{1}_{y \in (0, X_{k-1})} + \left( \frac{1}{y} - 1 \right) \mathbf{1}_{y \in (X_{k-1}, 1)} \right) dy,$$

independently of  $(M_1, \dots, M_k)$ .

The device provides us with a Markov chain  $(X_k, M_k, B_k)_{k \geq 0}$  such that the first two coordinates have the law of the process introduced before Proposition 9.13. We then let

$$T = \inf\{k \geq 0, B_k = 1\}.$$

By definition of  $T$ , the random variable  $X_T$  is sampled uniformly over  $[0, 1]$  and independently of  $(M_1, \dots, M_T)$ . We deduce that the process  $(X_{T+i}, M_{T+i})_{i \geq 1}$  has the same distribution as the process  $(X_{\mathfrak{z}_k}(U), M_{\mathfrak{z}_k}(U))_{k \geq 1}$  defined in Proposition 9.3, hence an easy adaptation of Proposition 9.3 shows that for every positive integer  $i$ ,  $X_{T+i}$  is uniformly distributed over  $[0, 1]$  independent of  $(M_1, \dots, M_{T+i})$  and of  $T$ . This proves the first part of Proposition 9.13.

For the second part, we need to evaluate the tail of the random time  $T$ . We introduce the following variation. Let  $(\hat{X}_k)_{k \geq 0}$  be a Markov chain with space state  $(0, 1) \cup \{\partial\}$ , where  $\partial$  is a cemetery point. Informally, this chain is the chain  $(X_k)$  until we reach the time  $T$ , then it is killed and sent to the cemetery point. Thanks to the calculation presented at the beginning of the proof, it should be clear that given  $X_{k-1}$  and conditionally on  $\{T \geq k-1\}$ , the probability of the event  $\{T = k\}$  is  $X_{k-1} \wedge (1 - X_{k-1})$ . Thus the transition probability for the chain  $(\hat{X}_k)$  is defined as follows : for every  $x \in (0, 1)$ ,

$$p(x, dy) = x \wedge (1 - x) \delta_\partial + \left( \frac{1 - x}{(1 - y)^2} \mathbf{1}_{y \in (0, x)} + \frac{x}{y^2} \mathbf{1}_{y \in (x, 1)} - x \wedge (1 - x) \right) dy,$$

and  $p(\partial, dy) = \delta_\partial$ . By construction of this chain, the stopping time  $\hat{T} = \inf\{k \geq 1 : \hat{X}_k = \partial\}$  has the same distribution as  $T$ . In order to estimate  $\hat{T}$ , we define the following potential function  $V : (0, 1) \cup \{\partial\} \rightarrow [1, \infty]$  :

$$V(x) = \mathbf{1}_{x=\partial} + \frac{10}{\sqrt{x}} \mathbf{1}_{x \in (0, 1/2)} + \frac{10}{\sqrt{1-x}} \mathbf{1}_{x \in [1/2, 1]}.$$

Then one can show that for every  $x \in (0, 1) \cup \{\partial\}$ ,

$$\int p(x, dy) V(y) \leq 0.85V(x) + \mathbf{1}_{\{\partial\}}(x),$$

so that [112, Theorem 15.2.5] may be applied : there exists  $\varepsilon > 0$  such that for all  $x \in (0, 1)$ ,

$$\mathbb{E} \left[ \sum_{k=0}^{\hat{T}-1} V(\hat{X}_k) 1.15^k \right] \leq \varepsilon^{-1} 1.15^{-1} V(x),$$

from which we deduce that

$$\mathbb{E} [1.15^{\hat{T}}] < \infty$$

(note that the last quantity is not uniformly bounded for  $x \in (0, 1)$ ). This completes the proof of Proposition 9.13.  $\square$

In the remaining part of this section,  $x$  is fixed in  $(0, 1)$ . Coming back to (9.3) and writing  $\overline{M}_k = M_1 M_2 \dots M_k$  for the Lebesgue measure of  $R_{3^k}(x)$ , we have

$$t^{-\beta^*} \mathbb{E} [N_t(x)] = t^{-\beta^*} \left( g_k(t) + 2^k \mathbb{E} \left[ \tilde{N}_{\overline{M}_k t - F_k}(X_k) \mathbf{1}_{T > k} \right] + 2^k \mathbb{E} \left[ \tilde{N}_{\overline{M}_k t - F_k}(X_k) \mathbf{1}_{T \leq k} \right] \right) \quad (9.14)$$

We shall treat separately the last two terms of (9.14).

#### 9.4.2 Study of $t^{-\beta^*} 2^k \mathbb{E} [\tilde{N}_{\overline{M}_k t - F_k}(X_k) \mathbf{1}_{T > k}]$

We shall see that  $t^{-\beta^*} 2^k \mathbb{E} [\tilde{N}_{\overline{M}_k t - F_k}(X_k) \mathbf{1}_{T > k}]$  is arbitrarily small uniformly in  $t$  provided that the integer  $k$  is chosen large enough. Observe

$$\begin{aligned} t^{-\beta^*} 2^k \mathbb{E} [\tilde{N}_{\overline{M}_k t - F_k}(X_k) \mathbf{1}_{T > k}] &\leq t^{-\beta^*} 2^k \mathbb{E} [\tilde{N}_{\overline{M}_k t}(X_k) \mathbf{1}_{T > k}] \\ &= 2^k \mathbb{E} \left[ \overline{M}_k^{\beta^*} (\overline{M}_k t)^{-\beta^*} \tilde{N}_{\overline{M}_k t}(X_k) \mathbf{1}_{T > k} \right] \\ &= 2^k \mathbb{E} \left[ \overline{M}_k^{\beta^*} \mathbf{1}_{T > k} \mathbb{E} \left[ (\overline{M}_k t)^{-\beta^*} \tilde{N}_{\overline{M}_k t}(X_k) \middle| \sigma(\overline{M}_k, X_k, T) \right] \right]. \end{aligned}$$

Letting  $\phi$  be the map  $(s, u) \mapsto \mathbb{E}[s^{-\beta^*} N_s(u)]$ , we have :

$$t^{-\beta^*} 2^k \mathbb{E}[\tilde{N}_{\bar{M}_k t - F_k}(X_k) \mathbf{1}_{T>k}] \leq 2^k \mathbb{E}[\bar{M}_k^{\beta^*} \mathbf{1}_{T>k} \phi(\bar{M}_k t, X_k)].$$

Thanks to (9.10),  $\phi \leq C$ , so that the quantity in the last display is at most  $C 2^k \mathbb{E}[\bar{M}_k^{\beta^*} \mathbf{1}_{T>k}]$ . Hölder’s inequality yields for every  $p > 1$

$$C 2^k \mathbb{E}[\bar{M}_k^{\beta^*} \mathbf{1}_{T>k}] \leq C 2^k \mathbb{E}[\bar{M}_k^{\beta^* p}]^{1/p} \mathbb{E}[\mathbf{1}_{T>k}]^{1-1/p}.$$

The last term is easily treated, by Markov’s inequality we have  $\mathbb{E}[\mathbf{1}_{T>k}] \leq 1.15^{-k} \mathbb{E}[1.15^T]$ . Concerning  $\mathbb{E}[\bar{M}_k^{\beta^* p}]$  we have

$$\begin{aligned} \mathbb{E}[\bar{M}_k^{\beta^* p}] &\leq \mathbb{E}[M_{32}(x)^{\beta^* p} \dots M_{3k}(x)^{\beta^* p}] \\ &= \int_0^1 f^{(x)}(y) dy \mathbb{E}[M_{31}(y)^{\beta^* p} \dots M_{3k-1}(y)^{\beta^* p}], \end{aligned}$$

where  $f^{(x)}$  is the density of  $X_1$  under  $\mathbb{P}$ . It is easy to see from (9.4) that  $f^{(x)}$  is bounded from above by  $(x \wedge (1-x))^{-1}$ . Hence

$$\mathbb{E}[\bar{M}_k^{\beta^* p}] \leq \frac{1}{x \wedge (1-x)} \int_0^1 dy \mathbb{E}[\bar{M}_{k-1}(y)^{\beta^* p}].$$

Recall from Proposition 9.3 that when  $x = U$  is uniform over  $[0, 1]$  and independent of  $(Q(t))_{t \geq 0}$ , then  $M_{31}(U), \dots, M_{3k}(U)$  are independent and distributed according to  $\mathbf{1}_{m \in [0,1]} 2(1-m) dm$ . In particular

$$\mathbb{E}[M_0(U)^{\beta^* p}] = \frac{2}{(\beta^* p + 1)(\beta^* p + 2)}$$

and thus

$$\int_0^1 dy \mathbb{E}[\bar{M}_{k-1}(y)^{\beta^* p}] = \left( \frac{2}{(\beta^* p + 1)(\beta^* p + 2)} \right)^{k-1}.$$

Gathering all these estimates, we obtain

$$\begin{aligned} &t^{-\beta^*} 2^k \mathbb{E}[N_{\bar{M}_k t - F_k}(X_k) \mathbf{1}_{T>k}] \\ &\leq C 2^k \left( \frac{1}{x \wedge (1-x)} \right)^{1/p} \left( \frac{2}{(\beta^* p + 1)(\beta^* p + 2)} \right)^{(k-1)/p} \mathbb{E}[1.15^T]^{1-1/p} 1.15^{-k(1-1/p)} \\ &= K_{p,x} \left( 2 \left\{ \frac{2}{(\beta^* p + 1)(\beta^* p + 2)} \right\}^{1/p} 1.15^{1/p-1} \right)^k, \end{aligned}$$

where  $K_{p,x}$  is a constant that only depends on  $p$  and  $x$  but not on  $k$ . Now, one can easily prove that for  $p > 1$  sufficiently close to 1, the term between brackets in the last display becomes strictly less than 1. Consequently, letting  $\varepsilon > 0$  fixed, there exists an integer  $k$  sufficiently large such that for every  $t > 0$ ,

$$t^{-\beta^*} 2^k \mathbb{E}[N_{\bar{M}_k t - F_k}(X_k) \mathbf{1}_{T>k}] \leq \varepsilon. \tag{9.15}$$



### 9.4.3 Conclusion

Observe that we have for every  $t > 0$

$$\begin{aligned} & t^{-\beta^*} 2^k \mathbb{E} \left[ \tilde{N}_{\overline{M}_k t - F_k}(X_k) \mathbf{1}_{T \leq k} \right] \\ &= 2^k \mathbb{E} \left[ \mathbf{1}_{T \leq k} \mathbb{E} \left[ t^{-\beta^*} \tilde{N}_{\overline{M}_k t - F_k}(X_k) \middle| \sigma(\overline{M}_k, F_k, T) \right] \right] \\ &= 2^k \mathbb{E} \left[ \mathbf{1}_{T \leq k} (\overline{M}_k - t^{-1} F_k)_+^{\beta^*} \mathbb{E} \left[ (\overline{M}_k t - F_k)_+^{-\beta^*} \tilde{N}_{\overline{M}_k t - F_k}(X_k) \middle| \sigma(\overline{M}_k, F_k, T) \right] \right], \end{aligned}$$

where  $y_+$  denotes  $y \vee 0$ . By Proposition 9.13, on the event  $\{T \leq k\}$ , the r.v.  $X_k$  is uniformly distributed over  $[0, 1]$  and independent of  $M_1, \dots, M_k$  thus of  $\overline{M}_k$ . It is also independent of  $F_k$  and  $T$ . Hence, letting  $\theta$  be the map  $s \mapsto \mathbb{E}[s_+^{-\beta^*} N_s(U)]$ , where  $U$  is a random variable uniformly distributed on  $(0, 1)$  independent of  $N$ , we have :

$$t^{-\beta^*} 2^k \mathbb{E} \left[ \tilde{N}_{\overline{M}_k t - F_k}(X_k) \mathbf{1}_{T \leq k} \right] = 2^k \mathbb{E} \left[ \mathbf{1}_{T \leq k} (\overline{M}_k - t^{-1} F_k)_+^{\beta^*} \theta(\overline{M}_k t - F_k) \right].$$

Applying Proposition 9.4,  $\theta(\overline{M}_k t - F_k)$  a.s. tends to a finite limit as  $t \rightarrow \infty$ . Hence by dominated convergence  $t^{-\beta^*} 2^k \mathbb{E} \left[ \tilde{N}_{\overline{M}_k t - F_k}(X_k) \mathbf{1}_{T \leq k} \right]$  has a finite limit as  $t \rightarrow \infty$ . We deduce from this fact, (9.14) and (9.15) that

$$\limsup_{t \rightarrow \infty} t^{-\beta^*} \mathbb{E} [N_t(x)] - \liminf_{t \rightarrow \infty} t^{-\beta^*} \mathbb{E} [N_t(x)] \leq \varepsilon.$$

Since that inequality holds for every  $\varepsilon > 0$ ,  $t^{-\beta^*} \mathbb{E}[N_t(x)]$  has a finite limit as  $t \rightarrow \infty$  which we denote by  $n_\infty(x)$  :

$$n_\infty(x) = \lim_{t \rightarrow \infty} t^{-\beta^*} \mathbb{E}[N_t(x)].$$

## 9.5 Identifying the limit

In this section, we show that  $x \mapsto n_\infty(x)$  is proportional to  $x \mapsto (x(1-x))^{\beta^*/2}$  using a fixed point argument for integral equation (see also [47, Section 4.1] for a similar application). The normalizing constant will come from the  $\mathbb{L}^1$ -norm of  $x \mapsto (x(1-x))^{\beta^*/2}$  and the constant of Proposition 9.4.

Combining (9.2) with the densities computed in (9.4), we deduce that

$$\begin{aligned} t^{-\beta^*} \mathbb{E}[N_t(x)] &= t^{-\beta^*} \mathbb{P}(t \geq \tau_1) + 2 \left( \int_x^1 \frac{dy}{y} \int_0^{\frac{x}{y}} dmm^{\beta^*} \mathbb{E} \left[ (mt)^{-\beta^*} N_{m(t-\tau_1)}(y) \right] \right. \\ &\quad \left. + \int_0^x \frac{dy}{1-y} \int_0^{\frac{1-x}{1-y}} dmm^{\beta^*} \mathbb{E} \left[ (mt)^{-\beta^*} N_{m(t-\tau_1)}(y) \right] \right). \end{aligned}$$

Thanks to Lemma 9.12, we get by dominated convergence

$$n_\infty(x) = \frac{2}{\beta^* + 1} \left( x^{\beta^*+1} \int_x^1 dy \frac{1}{y^{\beta^*+2}} n_\infty(y) + (1-x)^{\beta^*+1} \int_0^x dy \frac{1}{(1-y)^{\beta^*+2}} n_\infty(y) \right).$$

In other words, if we define

$$g_x(y) = \frac{2}{\beta^* + 1} \left( x^{\beta^*+1} \frac{1}{y^{\beta^*+2}} \mathbf{1}_{x < y < 1} + (1-x)^{\beta^*+1} \frac{1}{(1-y)^{\beta^*+2}} \mathbf{1}_{0 < y < x} \right),$$

we have

$$n_\infty(x) = \int_0^1 dy g_x(y) n_\infty(y).$$

Let  $G$  be the operator that maps a function  $f \in \mathbb{L}^1[0, 1]$  to the function

$$G(f)(x) = \int_0^1 dy g_x(y) f(y).$$

In particular,  $n_\infty$  is a fixed point of  $G$ . It is easy to check that  $x \in (0, 1) \mapsto g_x(\cdot) \in \mathbb{L}^1[0, 1]$  is continuous for the  $\mathbb{L}^1$ -norm. Furthermore, Lemma 9.12 ensures that  $|n_\infty(x)| \leq C$  for every  $x \in (0, 1)$ . As a consequence,  $x \mapsto n_\infty(x)$  is continuous over  $(0, 1)$ . An easy computation shows that for every  $y \in (0, 1)$ ,  $\int_0^1 dx g_x(y) = 1$ . Let  $p$  be another fixed point of  $G$  having the same integral as  $n_\infty$ . Then

$$\begin{aligned} \int_0^1 dx |n_\infty(x) - p(x)| &= \int_0^1 dx \left| \int_0^1 dy g_x(y) (n_\infty - p)(y) \right| \\ &\leq \int_0^1 dx \int_0^1 dy g_x(y) |n_\infty(y) - p(y)| \\ &= \int_0^1 dy |n_\infty(y) - p(y)|, \end{aligned}$$

which shows that the inequality is in fact an equality. Hence  $n_\infty - p$  has a.e. a constant sign. As we know that the integral of  $n_\infty - p$  is zero, we deduce that  $n_\infty = p$  a.e. Straightforward calculations prove that  $p_0 : x \mapsto (x(1-x))^{\beta^*/2}$  is also a fixed point of  $G$  of  $\mathbb{L}^1$ -norm, so that

$$n_\infty(x) = \|n_\infty\|_1 \|p_0\|_1^{-1} (x(1-x))^{\beta^*/2} \quad \text{a.e.}$$

Since  $n_\infty$  and  $p_0$  are continuous, we can remove the a.e. statement (observe that  $n_\infty(0) = n_\infty(1) = 0$  by Theorem 9.8). Plainly,

$$\|p_0\|_1 = \frac{\Gamma^2\left(\frac{\beta^*}{2} + 1\right)}{\Gamma(\beta^* + 2)}.$$

On the other hand, (9.10) and the dominated convergence theorem ensure that  $\|n_\infty\|_1 = \lim_{t \rightarrow \infty} t^{-\beta^*} \mathbb{E}[N_t(U)]$ , which was computed in Proposition 9.4 :

$$\|n_\infty\|_1 = \frac{\Gamma(2(\beta^* + 1))}{2\Gamma^3(\beta^* + 1)}.$$

*Proof of Theorem 9.1.* To sum up, we have for every  $x \in [0, 1]$  :

$$t^{-\beta^*} \mathbb{E}[N_t(x)] \xrightarrow{t \rightarrow \infty} \frac{\Gamma(2\beta^* + 2) \Gamma(\beta^* + 2)}{2\Gamma^3(\beta^* + 1) \Gamma^2\left(\frac{\beta^*}{2} + 1\right)} (x(1-x))^{\beta^*/2}.$$

Applying Lemma 9.2, Theorem 9.1 is shown. □

## 9.6 Extensions and comments

### 9.6.1 Various convergences

In this paper, we only proved a convergence in mean of  $t^{-\beta^*} N_t(x)$ . We may wonder whether this quantity also converges in distribution, in probability, or even almost surely. A more interesting question is the following : does the process  $((t^{-\beta^*} N_t(x))_{x \in [0,1]}, t > 0)$  converge in distribution in the Skorokhod sense to a random function  $(\mathcal{C}(x))_{x \in [0,1]}$  as  $t \rightarrow \infty$ ? Observe that if it does, then there exists a random point  $U$  uniformly distributed over  $(0, 1)$  such that  $\mathcal{C}(U) = 0$ ,  $U$  corresponding to the point  $x_1$  of the first atom of  $\Pi$  ( $N_t(x_1)$  is indeed of order  $t^{\sqrt{2}-1}$  by Theorem 9.8).

**Conjecture 1.** *We have the functional limit law  $(t^{-\beta^*} N_t(x))_{x \in [0,1]} \rightarrow (\mathcal{C}(x))_{x \in [0,1]}$  as  $t \rightarrow \infty$  in  $(\mathbb{D}([0, 1]), \|\cdot\|_\infty)$ , where  $\mathcal{C}$  satisfies the distributional fixed point equation*

$$\begin{aligned}
 (\mathcal{C}(x))_{x \in [0,1]} &\stackrel{(d)}{=} \left( \mathbf{1}_{x < U_0} \left\{ (U_0 U_1)^{\beta^*} \mathcal{C}^{(00)} \left( \frac{x}{U_0} \right) + (U_0(1 - U_1))^{\beta^*} \mathcal{C}^{(01)} \left( \frac{x}{U_0} \right) \right\} \right. \\
 &\quad \left. + \mathbf{1}_{x > U_0} \left\{ ((1 - U_0)U_1)^{\beta^*} \mathcal{C}^{(10)} \left( \frac{x - U_0}{1 - U_0} \right) \right. \right. \\
 &\quad \left. \left. + ((1 - U_0)(1 - U_1))^{\beta^*} \mathcal{C}^{(11)} \left( \frac{x - U_0}{1 - U_0} \right) \right\} \right)_{x \in [0,1]},
 \end{aligned}$$

where  $U_0, U_1, \mathcal{C}^{(00)}, \mathcal{C}^{(01)}, \mathcal{C}^{(10)}, \mathcal{C}^{(11)}$  are independent,  $U_0$  and  $U_1$  are uniformly distributed on  $[0, 1]$  and  $\mathcal{C}^{(00)}, \mathcal{C}^{(01)}, \mathcal{C}^{(10)}, \mathcal{C}^{(11)}$  have all the same distribution as  $\mathcal{C}$ .

### 9.6.2 Multidimensional case

The strategy adopted in Section 9.3.1 may be generalized to higher dimensions. As for the convergence in mean of the number of hyper-rectangles crossed by a *fixed* affine subspace having a direction generated by some vectors of the canonical basis, our approach may also be followed.

### 9.6.3 Quadtree as a model of random geometry

On top of its numerous applications in theoretical computer science, the model of random quadtree may be considered as a model of random geometry. More precisely one can view, for  $t \geq 0$ , the set of rectangles  $Q(t)$  as a random graph, assigning length 1 to each edge of the rectangles. We denote this graph by  $\tilde{Q}(t)$ . A natural question would be to understand the metric behavior of  $\tilde{Q}(t)$  as  $t \rightarrow \infty$ . The study of the graph distance  $L_t$  in  $\tilde{Q}(t)$  between the upper-left and upper-right corners would be a first step in understanding the global geometry of  $\tilde{Q}_t$ . Observe that Theorem 9.8 already shows that  $L_t$  is less than the order  $t^{\sqrt{2}-1}$ .

## Bibliographie

---

- [1] L. Addario-Berry, N. Broutin, and C. Goldschmidt. Critical random graphs : limiting constructions and distributional properties. *Electron. J. Probab.*, 15 :no. 25, 741–775, 2010.
- [2] D. Aldous. The continuum random tree. I. *Ann. Probab.*, 19(1) :1–28, 1991.
- [3] D. Aldous. The continuum random tree. II. An overview. In *Stochastic analysis (Durham, 1990)*, volume 167 of *London Math. Soc. Lecture Note Ser.*, pages 23–70. Cambridge Univ. Press, Cambridge, 1991.
- [4] D. Aldous. The continuum random tree III. *Ann. Probab.*, 21(1) :248–289, 1993.
- [5] D. Aldous. Recursive self-similarity for random trees, random triangulations and brownian excursion. *Ann. Probab.*, 22(2) :527–545, 1994.
- [6] D. Aldous. Triangulating the circle, at random. *Amer. Math. Monthly*, 101(3), 1994.
- [7] D. Aldous and R. Lyons. Processes on unimodular random networks. *Electron. J. Probab.*, 12 :no. 54, 1454–1508 (electronic), 2007.
- [8] N. Alon. Packings with large minimum kissing numbers. *Discrete Math.*, 175(1-3) :249–251, 1997.
- [9] J. Ambjørn, B. Durhuus, and T. Jonsson. *Quantum geometry*. Cambridge Monographs on Mathematical Physics. Cambridge University Press, Cambridge, 1997. A statistical field theory approach.
- [10] O. Angel. Growth and percolation on the uniform infinite planar triangulation. *Geom. Funct. Anal.*, 13(5) :935–974, 2003.
- [11] O. Angel and O. Schramm. Uniform infinite planar triangulation. *Comm. Math. Phys.*, 241(2-3) :191–213, 2003.
- [12] K. B. Athreya and P. E. Ney. *Branching processes*, volume 196 of *Die Grundlehren der mathematischen Wissenschaften*. Springer-Verlag, 1972.
- [13] A. Avez. Théorème de Choquet-Deny pour les groupes à croissance non exponentielle. *C. R. Acad. Sci. Paris Sér. A*, 279 :25–28, 1974.
- [14] B. Benedetti and G. M. Ziegler. On locally constructible spheres and balls. 2009.
- [15] I. Benjamini. Random planar metrics. *Proceedings of the ICM 2010*, 2010.
- [16] I. Benjamini and N. Curien. On limits of graphs sphere packed in euclidean space and applications. *Electron. J. Combin. (to appear)*.

- [17] I. Benjamini and N. Curien. Ergodic theory on stationary random graphs. *arxiv :1011.2526*, 2010.
- [18] I. Benjamini, R. Lyons, Y. Peres, and O. Schramm. Group-invariant percolation on graphs. *Geom. Funct. Anal.*, 9(1) :29–66, 1999.
- [19] I. Benjamini and O. Schramm. Harmonic functions on planar and almost planar graphs and manifolds, via circle packings. *Invent. Math.*, 126(3) :565–587, 1996.
- [20] I. Benjamini and O. Schramm. Random walks and harmonic functions on infinite planar graphs using square tilings. *Ann. Probab.*, 24(3) :1219–1238, 1996.
- [21] I. Benjamini and O. Schramm. Recurrence of distributional limits of finite planar graphs. *Electron. J. Probab.*, 6(23), 2001.
- [22] I. Benjamini and O. Schramm. Lack of sphere packings of graphs via non-linear potential theory. 2009.
- [23] N. Berger. Transience, recurrence and critical behavior for long-range percolation. *Comm. Math. Phys.*, 226(3) :531–558, 2002.
- [24] J. Bertoin. *Random Fragmentations and Coagulation Processes*. Number 102 in Cambridge Studies in Advanced Mathematics. Cambridge University Press, 2006.
- [25] J. Bertoin and A. Gnedin. Asymptotic laws for nonconservative self-similar fragmentations. *Electron. J. Probab.*, 9(19) :575–593, 2004.
- [26] J. Bettinelli. The topology of scaling limits of positive genus random quadrangulations.
- [27] J. Bettinelli. Scaling limits for random quadrangulations of positive genus. *Electron. J. Probab.*, 15 :1594–1644, 2010.
- [28] N. H. Bingham, C. M. Goldie, and J. L. Teugels. *Regular variation*, volume 27 of *Encyclopedia of Mathematics and its Applications*. Cambridge University Press, Cambridge, 1989.
- [29] M. Biskup. Graph diameter in long-range percolation. *arXiv :math/0406379*, 2009.
- [30] F. Bonahon. Geodesic laminations on surfaces. In *Laminations and foliations in dynamics, geometry and topology (Stony Brook, NY, 1998)*, volume 269 of *Contemp. Math.*, pages 1–37. Amer. Math. Soc., Providence, RI, 2001.
- [31] M. Bousquet-Mélou and A. Jehanne. Polynomial equations with one catalytic variable, algebraic series and map enumeration. *J. Combin. Theory Ser. B*, 96(5) :623–672, 2006.
- [32] J. Bouttier, P. Di Francesco, and E. Guitter. Planar maps as labeled mobiles. *Electron. J. Combin.*, 11(1) :Research Paper 69, 27 pp. (electronic), 2004.
- [33] J. Bouttier and E. Guitter. The three-point function of planar quadrangulations. *J. Stat. Mech. Theory Exp.*, (7) :P07020, 39, 2008.
- [34] J. Bouttier and E. Guitter. Confluence of geodesic paths and separating loops in large planar quadrangulations. *J. Stat. Mech. Theory Exp.*, (3) :P03001, 44, 2009.

- [35] B. H. Bowditch. A short proof that a subquadratic isoperimetric inequality implies a linear one. *Michigan Math. J.*, 42(1) :103–107, 1995.
- [36] M. Brennan and R. Durrett. Splitting intervals. *Ann. Probab.*, 14(3) :1024–1036, 1986.
- [37] M. Brennan and R. Durrett. Splitting intervals ii : Limit laws for lengths. *Probab. Theory Related Fields*, 75(1) :109–127, 1987.
- [38] E. Brézin, C. Itykson, G. Parisi, and J.-B. Zuber. Planar diagrams. *Comm. Math. Phys.*, 1978.
- [39] R. L. Brooks, C. A. B. Smith, A. H. Stone, and W. T. Tutte. The dissection of rectangles into squares. *Duke Math. J.*, 7 :312–340, 1940.
- [40] D. Burago, Y. Burago, and S. Ivanov. *A course in metric geometry*, volume 33 of *Graduate Studies in Mathematics*. American Mathematical Society, Providence, RI, 2001.
- [41] G. Chapuy, M. Marcus, and G. Schaeffer. A bijection for rooted maps on orientable surfaces. *SIAM J. Discrete Math.*, 23(3) :1587–1611, 2009.
- [42] P. Chassaing and B. Durhuus. Local limit of labeled trees and expected volume growth in a random quadrangulation. *Ann. Probab.*, 34(3) :879–917, 2006.
- [43] P. Chassaing and G. Schaeffer. Random planar lattices and integrated super-Brownian excursion. *Probab. Theory Related Fields*, 128(2) :161–212, 2004.
- [44] H.-H. Chern and H.-K. Hwang. Partial match queries in random quadrees. *SIAM J. Comput.*, 32(4) :904–915 (electronic), 2003.
- [45] R. Cori and B. Vauquelin. Planar maps are well labeled trees. *Canad. J. Math.*, 33(5) :1023–1042, 1981.
- [46] N. Curien and A. Joseph. Partial match queries in random quadrees : A probabilistic approach. *Adv. in Appl. Probab. (to appear)*.
- [47] N. Curien and J.-F. Le Gall. Random recursive triangulations of the disk *via* fragmentation theory. *Ann. Probab.* to appear.
- [48] N. Curien, J.-F. Le Gall, and G. Miermont. The brownian cactus I. scaling limits of discrete cactuses. *arXiv :1102.4177*.
- [49] N. Curien, L. Ménard, and G. Miermont. A view from infinity of the uniform infinite planar quadrangulation (in preparation). 2010.
- [50] N. Curien and Y. Peres. Random laminations and multitype branching processes. *preprint*.
- [51] F. David, W. Dukes, T. Jonsson, and S. Stefánsson. Random tree growth by vertex splitting. *J. Stat. Mech.*, 2009.
- [52] F. David, C. Hagendorf, and K. J. Wiese. A growth model for rna secondary structures. *preprint available on arxiv*, 2008.
- [53] F. M. Dekking. On transience and recurrence of generalized random walks. *Z. Wahrsch. Verw. Gebiete*, 61(4) :459–465, 1982.

- [54] Y. Derriennic. Quelques applications du théorème ergodique sous-additif. In *Conference on Random Walks (Kleebach, 1979) (French)*, volume 74 of *Astérisque*, pages 183–201, 4. Soc. Math. France, Paris, 1980.
- [55] L. Devroye, P. Flajolet, F. Hurtado, and W. Noy, M. and Steiger. Properties of random triangulations and trees. *Discrete Comput. Geom.*, 22(1), 1999.
- [56] P. Di Francesco. 2D quantum gravity, matrix models and graph combinatorics. In *Applications of random matrices in physics*, volume 221 of *NATO Sci. Ser. II Math. Phys. Chem.*, pages 33–88. Springer, Dordrecht, 2006.
- [57] P. G. Doyle and J. L. Snell. *Random walks and electric networks*, volume 22 of *Carus Mathematical Monographs*. Mathematical Association of America, Washington, DC, 1984.
- [58] R. J. Duffin. The extremal length of a network. *J. Math. Anal. Appl.*, 5 :200–215, 1962.
- [59] B. Duplantier and S. Sheffield. Duality and the Knizhnik-Polyakov-Zamolodchikov relation in Liouville quantum gravity. *Phys. Rev. Lett.*, 102(15) :150603, 4, 2009.
- [60] T. Duquesne and J.-F. Le Gall. Random trees, Lévy processes and spatial branching processes. *Astérisque*, (281) :vi+147, 2002.
- [61] T. Duquesne and J.-F. Le Gall. Probabilistic and fractal aspects of Lévy trees. *Probab. Theory Related Fields*, 131(4) :553–603, 2005.
- [62] J. Dutronc. Les cactus. *Vogue*, 1966.
- [63] S. N. Evans. *Probability and real trees*, volume 1920 of *Lecture Notes in Mathematics*. Springer, Berlin, 2008. Lectures from the 35th Summer School on Probability Theory held in Saint-Flour, July 6–23, 2005.
- [64] S. N. Evans, J. Pitman, and A. Winter. Rayleigh processes, real trees, and root growth with re-grafting. *Probab. Theory Related Fields*, 134(1) :81–126, 2006.
- [65] C. Favre and M. Jonsson. *The valuative tree*, volume 1853 of *Lecture Notes in Mathematics*. Springer-Verlag, Berlin, 2004.
- [66] R. A. Finkel and J. L. Bentley. Quad trees a data structure for retrieval on composite keys. *Acta Informatica*, 4(1) :1–9, mars 1974.
- [67] P. Flajolet, G. Gonnet, C. Puech, and J. M. Robson. Analytic variations on quadtrees. *Algorithmica*, 10(6) :473–500, 1993.
- [68] P. Flajolet, G. Labelle, L. Laforest, and B. Salvy. Hypergeometrics and the cost structure of quadtrees. *Random Structures Algorithms*, 7(2) :117–144, 1995.
- [69] P. Flajolet and R. Sedgewick. *Analytic combinatorics*. Cambridge University Press, Cambridge, 2009.
- [70] D. Gaboriau. Invariant percolation and harmonic Dirichlet functions. *Geom. Funct. Anal.*, 15(5) :1004–1051, 2005.
- [71] J. T. Gill and S. Rohde. On the riemann surface type of random planar maps (preprint).

- [72] J. T. Gill and S. Rohde. On the riemann surface type of random planar maps. *preprint available on arxiv*, 2011.
- [73] O. Giménez and M. Noy. Counting planar graphs and related families of graphs. In *Surveys in combinatorics 2009*, volume 365 of *London Math. Soc. Lecture Note Ser.*, pages 169–210. Cambridge Univ. Press, Cambridge, 2009.
- [74] M. Gromov. Hyperbolic manifolds, groups and actions. In *Riemann surfaces and related topics : Proceedings of the 1978 Stony Brook Conference (State Univ. New York, Stony Brook, N.Y., 1978)*, volume 97 of *Ann. of Math. Stud.*, pages 183–213. Princeton Univ. Press, Princeton, N.J., 1981.
- [75] M. Gromov. *Metric structures for Riemannian and non-Riemannian spaces*. Modern Birkhäuser Classics. Birkhäuser Boston Inc., Boston, MA, english edition, 2007. Based on the 1981 French original, With appendices by M. Katz, P. Pansu and S. Semmes, Translated from the French by Sean Michael Bates.
- [76] O. Häggström. Infinite clusters in dependent automorphism invariant percolation on trees. *Ann. Probab.*, 25(3) :1423–1436, 1997.
- [77] Z.-X. He and O. Schramm. Hyperbolic and parabolic packings. *Discrete Comput. Geom.*, 14 :123–149, 1995.
- [78] A. Iserles and Y. Liu. Integro-differential equations and generalized hypergeometric functions. *J. Math. Anal. Appl.*, 208(2) :404–424, 1997.
- [79] N. C. Jain and S. J. Taylor. Local asymptotic laws for Brownian motion. *Ann. Probability*, 1 :527–549, 1973.
- [80] V. A. Kaimanovich. Boundary and entropy of random walks in random environment. In *Probability theory and mathematical statistics, Vol. I (Vilnius, 1989)*, pages 573–579. “Mokslas”, Vilnius, 1990.
- [81] V. A. Kaimanovich, Y. Kifer, and B.-Z. Rubshtein. Boundaries and harmonic functions for random walks with random transition probabilities. *J. Theoret. Probab.*, 17(3) :605–646, 2004.
- [82] V. A. Kaimanovich and F. Sobieczky. Stochastic homogenization of horospheric tree products. In *Probabilistic approach to geometry*, volume 57 of *Adv. Stud. Pure Math.*, pages 199–229. Math. Soc. Japan, Tokyo, 2010.
- [83] V. A. Kaimanovich and A. M. Vershik. Random walks on discrete groups : boundary and entropy. *Ann. Probab.*, 11(3) :457–490, 1983.
- [84] V. A. Kaimanovich and W. Woess. Boundary and entropy of space homogeneous Markov chains. *Ann. Probab.*, 30(1) :323–363, 2002.
- [85] H. Kesten. Subdiffusive behavior of random walk on a random cluster. *Ann. Inst. H. Poincaré Probab. Statist.*, 22(4) :425–487, 1986.
- [86] V. G. Knizhnik, A. M. Polyakov, and A. B. Zamolodchikov. Fractal structure of 2D-quantum gravity. *Modern Phys. Lett. A*, 3(8) :819–826, 1988.
- [87] A. N. Kolmogorov. Zur lösung einer biologischen aufgabe [german : On the solution of a problem in biology]. *Izv. NII Matem. Mekh. Tomskogo Univ.*, 2 :7–12, 1938.



- [88] E. Kopczyński, I. Pak, and P. Przytycki. Acute triangulations of polyhedra and  $\mathbb{R}^n$ .
- [89] M. Krikun. Local structure of random quadrangulations. *arXiv :0512304*.
- [90] M. Krikun. On one property of distances in the infinite random quadrangulation. *arXiv :0805.1907*.
- [91] M. Krikun. A uniformly distributed infinite planar triangulation and a related branching process. *Zap. Nauchn. Sem. S.-Peterburg. Otdel. Mat. Inst. Steklov. (POMI)*, 307(Teor. Predst. Din. Sist. Komb. i Algoritm. Metody. 10) :141–174, 282–283, 2004.
- [92] G. Kuperberg and O. Schramm. Average kissing numbers for non-congruent sphere packings. *Math. Res. Lett.*, 1994.
- [93] S. K. Lando and A. Zvonkin. *Graphs on surfaces and their applications*. Springer-Verlag, 2004.
- [94] J.-F. Le Gall. The brownian cactus II. upcrossings and super-brownian motion. *In In preparation*.
- [95] J.-F. Le Gall. The uniform random tree in a Brownian excursion. *Probab. Theory Related Fields*, 96(3) :369–383, 1993.
- [96] J.-F. Le Gall. *Spatial branching processes, random snakes and partial differential equations*. Lectures in Mathematics ETH Zürich. Birkhäuser Verlag, Basel, 1999.
- [97] J.-F. Le Gall. Random real trees. *Ann. Fac. Sci. Toulouse Math. (6)*, 15(1) :35–62, 2006.
- [98] J.-F. Le Gall. The topological structure of scaling limits of large planar maps. *Invent. Math.*, 169(3) :621–670, 2007.
- [99] J.-F. Le Gall. Geodesics in large planar maps and in the brownian map. *Acta Math.*, 205 :287–360, 2010.
- [100] J.-F. Le Gall. Uniqueness and universality of the brownian map. *available on arxiv*, 2011.
- [101] J.-F. Le Gall and L. Ménard. Scaling limits for the uniform infinite planar quadrangulation. *arXiv :1005.1738*.
- [102] J.-F. Le Gall and F. Paulin. Scaling limits of bipartite planar maps are homeomorphic to the 2-sphere. *Geom. Funct. Anal.*, 18(3) :893–918, 2008.
- [103] J.-F. Le Gall and M. Weill. Conditioned brownian trees. *Ann. Inst. Henri Poincaré*, 2006.
- [104] Q. Liu. Sur une équation fonctionnelle et ses applications : une extension du théorème de Kesten-Stigum concernant des processus de branchement. *Adv. in Appl. Probab.*, 29(2) :353–373, 1997.
- [105] Q. Liu. Asymptotic properties and absolute continuity of laws stable by random weighted mean. *Stochastic Process. Appl.*, 95(1) :83–107, 2001.
- [106] R. Lyons, R. Pemantle, and Y. Peres. Ergodic theory on Galton-Watson trees : speed of random walk and dimension of harmonic measure. *Ergodic Theory Dynam. Systems*, 15(3) :593–619, 1995.

- [107] R. Lyons and Y. Peres. *Probability on Trees and Networks*. Current version available at <http://mypage.iu.edu/~rdlyons/>, In preparation.
- [108] F.-Y. Maeda. A remark on parabolic index of infinite networks. *Hiroshima Math. J.*, 7(1) :147–152, 1977.
- [109] J.-F. Marckert and G. Miermont. Invariance principles for random bipartite planar maps. *Ann. Probab.*, 35(5) :1642–1705, 2007.
- [110] J.-F. Marckert and A. Mokkadem. Limit of normalized quadrangulations : the Brownian map. *Ann. Probab.*, 34(6) :2144–2202, 2006.
- [111] L. Ménard. The two uniform infinite quadrangulations of the plane have the same law. *Ann. Inst. H. Poincaré Probab. Statist.*, 46(1) :190–208, 2010.
- [112] S. Meyn and R. L. Tweedie. *Markov chains and stochastic stability*. Cambridge University Press, Cambridge, second edition, 2009. With a prologue by Peter W. Glynn.
- [113] G. Miermont. Cours sur les cartes planaires aléatoires.
- [114] G. Miermont. An invariance principle for random planar maps. In *Fourth Colloquium on Mathematics and Computer Science Algorithms, Trees, Combinatorics and Probabilities*, Discrete Math. Theor. Comput. Sci. Proc., AG, pages 39–57. Assoc. Discrete Math. Theor. Comput. Sci., Nancy, 2006.
- [115] G. Miermont. Invariance principles for spatial multitype Galton-Watson trees. *Ann. Inst. Henri Poincaré Probab. Stat.*, 44(6) :1128–1161, 2008.
- [116] G. Miermont. On the sphericity of scaling limits of random planar quadrangulations. *Electron. Commun. Probab.*, 13 :248–257, 2008.
- [117] G. Miermont. Tessellations of random maps of arbitrary genus. *Ann. Sci. Éc. Norm. Supér. (4)*, 42(5) :725–781, 2009.
- [118] G. Miermont. The brownian map is the scaling limit of uniform random plane quadrangulations. *arXiv :1104.1606*, 2011.
- [119] G. Miermont and M. Weill. Radius and profile of random planar maps with faces of arbitrary degrees. *Electron. J. Probab.*, 13 :no. 4, 79–106, 2008.
- [120] M. Müller. *Repliement d’hétéropolymères*. PhD thesis, Université Paris-Sud, <http://users.ictp.it/~markusm/PhDThesis.pdf>, 2003.
- [121] J. Neveu. Arbres et processus de Galton-Watson. *Ann. Inst. H. Poincaré Probab. Statist.*, 22(2) :199–207, 1986.
- [122] F. Paulin. Propriétés asymptotiques des relations d’équivalences mesurées discrètes. *Markov Process. Related Fields*, 5(2) :163–200, 1999.
- [123] D. Revuz and M. Yor. *Continuous martingales and Brownian motion*, volume 293 of *Grundlehren der Mathematischen Wissenschaften [Fundamental Principles of Mathematical Sciences]*. Springer-Verlag, Berlin, third edition, 1999.
- [124] I. Richards. On the classification of noncompact surfaces. *Trans. Amer. Math. Soc.*, 106 :259–269, 1963.
- [125] B. Rodin and D. Sullivan. The convergence of circle packings to the riemann mapping. *J. Differential Geom.*, 26(2) :349–360, 1987.

- [126] S. Rohde. Oded Schramm : From circle packing to sle.
- [127] G. Schaeffer. Conjugaison d’arbres et cartes combinatoires aléatoires. phd thesis. 1998.
- [128] O. Schramm. Square tilings with prescribed combinatorics. *Israel J. Math.*, 84(1-2) :97–118, 1993.
- [129] O. Schramm. Conformally invariant scaling limits : an overview and a collection of problems. *Plenary Lecture ICM Madrid 2006*, 2006.
- [130] E. Seneta and D. Vere-Jones. On quasi-stationary distributions in discrete-time Markov chains with a denumerable infinity of states. *J. Appl. Probability*, 3 :403–434, 1966.
- [131] S. Sheffield. Conformal weldings of random surfaces : Sle and the quantum gravity zipper, 2010.
- [132] D. D. Sleator, R. E. Tarjan, and W. P. Thurston. Rotation distance, triangulations, and hyperbolic geometry. *J. Amer. Math. Soc.*, 1(3) :647–681, 1988.
- [133] P. M. Soardi. *Potential theory on infinite networks*, volume 1590 of *Lecture Notes in Mathematics*. Springer-Verlag, Berlin, 1994.
- [134] P. M. Soardi and W. Woess. Amenability, unimodularity, and the spectral radius of random walks on infinite graphs. *Math. Z.*, 205(3) :471–486, 1990.
- [135] P. M. Soardi and M. Yamasaki. Parabolic index and rough isometries. *Hiroshima Math. J.*, 23(2) :333–342, 1993.
- [136] R. P. Stanley. *Enumerative combinatorics. Vol. 2*, volume 62 of *Cambridge Studies in Advanced Mathematics*. Cambridge University Press, Cambridge, 1999. With a foreword by Gian-Carlo Rota and appendix 1 by Sergey Fomin.
- [137] K. Stephenson. *Introduction to circle packing*. Cambridge University Press, Cambridge, 2005. The theory of discrete analytic functions.
- [138] G. ’t Hooft. A planar diagram theory for strong interactions. *Nuclear Physics B*, 72 :461–473, 1974.
- [139] W. T. Tutte. A census of Hamiltonian polygons. *Canad. J. Math.*, 14 :402–417, 1962.
- [140] W. T. Tutte. A census of planar triangulations. *Canad. J. Math.*, 14 :21–38, 1962.
- [141] W. T. Tutte. A census of slicings. *Canad. J. Math.*, 14 :708–722, 1962.
- [142] W. T. Tutte. A census of planar maps. *Canad. J. Math.*, 15 :249–271, 1963.
- [143] W. T. Tutte. On the enumeration of four-colored maps. *SIAM J. Appl. Math.*, 17 :454–460, 1969.
- [144] J. Vasilis. On the ring lemma.
- [145] A. M. Vershik. Dynamic theory of growth in groups : entropy, boundaries, examples. *Uspekhi Mat. Nauk*, 55(4(334)) :59–128, 2000.
- [146] Y. Watabiki. Construction of non-critical string field theory by transfer matrix formalism in dynamical triangulation. *Nuclear Phys. B*, 441(1-2) :119–163, 1995.

- [147] A. Zvonkin. Matrix integrals and map enumeration : an accessible introduction. *Math. Comput. Modelling*, 26(8-10) :281–304, 1997. Combinatorics and physics (Marseilles, 1995).